

clever

G R I F F E R Í A



Bath & Kitchen

— COLLECTION 2018 —



Grifería Clever nace en 1998 de **Standard Hidráulica S.A.U.**, empresa fundada en Barcelona en 1975 y reconocida como uno de los principales fabricantes de **grifería y accesorios para cocina y baño** en **España**. La **calidad**, el **servicio**, la **innovación** y el **exquisito diseño**, unido a una constante **investigación tecnológica** y una cuidada **atención al cliente**, son las bases de la filosofía empresarial de nuestra empresa.

Clever taps were launched in 1998 by Standard Hidraulica, company founded in 1975, well known as one of the most important taps and showers manufacturers in Spain. Our company's philosophy is based in quality, service, innovation, exquisite design and technology investigation.

Clever est né en 1998 au sein de Standard Hidráulica S.A.U., une entreprise fondée à Barcelone en 1975, et reconnue comme l'un des principaux fabricants de robinetterie pour la cuisine, la salle de bains et les collectivités en Espagne. La qualité, le service, l'innovation et les designs exquis, combinés avec l'intégration constante des nouvelles technologies et le suivi attentif de notre clientèle sont les fondements de la philosophie d'entreprise de notre société.

PLATINUM

Ventu	22
Aude	24
Selene	26
Bimini	28
Marina Evo	34
Saona Slim	36
Paula	38
Nine <i>elegance</i>	42
Nine xtreme	44

STYLES

Agora <i>elegance</i>	48
Agora xtreme	50
Artic xtreme	52
Artic urban	54
Caiman <i>elegance</i>	56
Caiman xtreme	60
Caiman urban	62
With2 <i>Antigona</i>	64
With2 Morea	68

STYLES PRO

Bahama xtreme	74
Habana xtreme	76
Start <i>elegance</i>	78
Start xtreme	82
Start urban	86
Panam <i>elegance</i>	88
Panam xtreme	90
Panam urban	92
S12 <i>elegance</i>	96
S12 xtreme	98
S12 urban	100
With2 <i>Guayama</i>	102
Nine urban	104

Accesorios de baño

Platinum	112
<i>elegance</i>	114
xtreme	116
urban	118

HIDROCLEVER

iClever	126
Rociadores <i>Shower heads / Pomme de douche</i>	134
Conjunto de ducha <i>Shower kit / Kit douche</i>	140
Brazo rociador <i>Shower arm Brass pour pomme de douche</i>	142
Teléfono ducha <i>Handsets / Douchettes</i>	142
Soportes <i>Wall brackets / Supports</i>	146
Barras de ducha <i>Slidings bars / Barre de douche</i>	147
Flexibles <i>Flexibles / Flexibles</i>	148
<i>Salida flexo</i> <i>Wall outlet / Sortie flexible</i>	148
Caños <i>Bath spouts / Bec</i>	149
Jets Hidromasaje <i>Body jets / Jets</i>	149

GAMA BOX

Termostáticos <i>Thermostatics / Thermostatiques</i>	152
Monomandos <i>Single lever mixers / Mitigeurs</i>	154
Sobremesa <i>Floorstands / Présentoirs</i>	156

COCINA

Chef	162
Abatibles <i>Folding spout / Bec rabattable</i>	172
Osmosis <i>Osmosis / Eau purifiée</i>	174
Platinum	176
Styles	180
Styles Pro	186
Gerontológico.....	200
<i>Medical lever / Manette médicale</i>	

Tratamiento de agua

Komeo	204
Recambios <i>Spare parts / Pièces de rechange</i>	207

COLECTIVIDADES

Temporizados <i>Delay action / Temporisés</i>	210
Ducha higiénica <i>Shattaf / Douche hygiénique</i>	211
Grifos individuales <i>Cold water taps / Robinets individuels</i>	213
Gerontológicos <i>Medicals / P.M.R.</i>	215

TERMOSTÁTICOS

Termostáticos <i>Thermostatics / Thermostatiques</i>	219
---	-----

SISTEMAS DE DUCHA y BAÑO-DUCHA

Termostáticos extensibles <i>Adjustable thermostatics</i> <i>Thermostatiques extensibles</i>	226
Termostáticos no extensibles <i>Non-adjustable thermostatics</i> <i>Thermostatiques non extensibles</i>	228
Monomandos extensibles <i>Adjustable single lever</i> <i>Mitigeurs extensibles</i>	230
Bimandos extensibles <i>Adjustable two handles</i> <i>Mélangeurs extensibles</i>	231
Monomandos no extensibles <i>Non-adjustable single lever</i> <i>Mitigeurs non extensibles</i>	231

CyR

Complementos y recambios <i>Accessories and spare parts</i> <i>Accessoires et Pièces de rechange</i> ..	232
---	-----

Expositores

Expositores sobremesa <i>Display stand over-table</i> <i>Présentoirs</i>	250
Clever Maxi	252

Off Clever

Mikura	260
Marina	263
Bahama urban	264
Saona	265
Chef	265
Temporizados <i>Delay action / Temporisés</i>	266
Desagües <i>Pop-up wastes / Vidages</i>	266

INFORMACIÓN

Información técnica <i>Technical information</i> <i>Information technique</i>	270
Certificados <i>Certificates / Certificats</i>	282
Índice de referencias <i>Item directory</i> <i>Index des références</i>	286
Condiciones de venta <i>Sales conditions</i> <i>Conditions a vendre</i>	292

NEW

NOVEDADES

News / Nouveautés



Nine Slim **urban**

PÁG. 104

Escobilleros de pared
Toilet brush holder / Porte Balai WC mural

PLATINUM
elegance
xtreme
urban



PÁG. 110
(PÁG. 113-115-119-123)

Expositor Leo.
Válvula desagüe metálico
Leo display. Metallic drain quick-clac
Présentoir Leo. Vidage métallique

PÁG. 237



Expositores Clever Maxi
Clever Maxi display / Présentoir Clever Maxi
PÁG. 252

Expositor sobremesa de cocina
Kitchen faucet display stand over-table
Présentoir robinetterie de cuisine
PÁG. 250



komeo

CENTRAL
DE TRATAMIENTO
DE AGUA

Inhibe la cal
y Purifica

Descalles & Purifies
Détartre & Purifie



Connected 

[Ver página](#)

See page/ Voir la page 203

COMAP

NEW
certification



Nuevas certificaciones AENOR

New AENOR certifications / Nouvelles certifications AENOR



Start elegance



Start xtreme

Lavabo, bidé, ducha, baño-ducha y fregadero
Basin mixer, bidet mixer, shower mixer, bath-shower mixer and sink mixer
Mitigeurs lavabo, bidet, douche, bain-douche et évier

PÁG. 78

PÁG. 82



Nine urban



Ducha y conjunto de ducha termostático
Thermostatic shower mixer and shower system
Mitigeur douche et Colonne thermostatique douche

PÁG. 104

La excelencia en el proceso de fabricación



Diseño
Design | Design



Moldes
Molds | Moules



Pulido
Polishing | Polissage



Cromado
*Chrome plating
Chromage*

The excellence in the manufacturing process
L'excellence dans le processus de fabrication

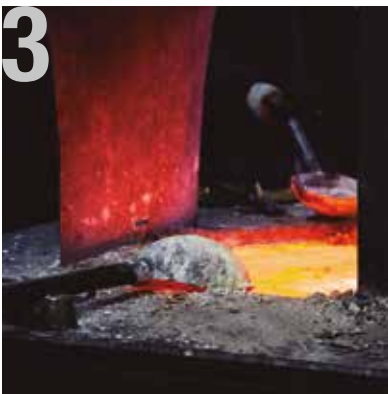

Fundición
Casting / Fonte



Extracción noyo arena
Sand core pullers extraction
Extraction des noyaux de sable



Mecanizado
Machining / Usinage



Montaje
Assembly
Assemblage



Control de calidad
Quality control
Contrôle de qualité



Certificados / Certificats / Certificats

La tecnología más avanzada en grifería

The most advanced technology in taps and showers
La technologie la plus avancée dans les robinets



Cartucho distribuidor cerámico
Ceramic cartridge distributor
Cartouche dérivateur céramique

gitec



Cartucho termostático sensor Vernet fabricado según EN 1111
Thermostatic cartridge (EN 1111)
Cartouche thermostatique (Norme EN 1111)

Vernet

cosedal
THE PROJECT'S HEART



Cold Touch System patentado
Cold Touch system patented
Système Cold Touch breveté
(Norme EN 1111)



Proceso de cromado compuesto por 44 pasos, máxima resistencia a la corrosión

Chroming process comprising 44 steps, high corrosion resistance

Le processus de chromage comprends 44 étapes, pour une résistance maximale à la corrosion



Bajo porcentaje de plomo
Cu 60% +0,5. Pb<1,6%

*Low percentage of lead
60% Cu + -0.5. Pb <1.6%*

*Faible pourcentage de plomb
60% Cu + -0,5. Pb <1,6%*



EPDM/PEX. Certificación AENOR y CSTBat. Fabricados según norma UNE EN 13618

EPDM / PEX. AENOR and CSTBat certification. (UNEEN 13618)

EPDM / PEX. Certification AENOR et CSTBat. (Norme ENE EN 13618)



Aireadores de última generación
*Aerators new generation
Aérateurs de nouvelle génération*



Cartuchos con cerámicas de alta precisión. Fabricados para superar UNE EN 817

Ceramic cartridges with highly precision. (UNE EN 817)

Cartouches céramiques de grande précision. (Norme UNE EN 817)



CÓMO AHORRAR AGUA EN CASA CON clever

Descubre los beneficios de EcoCLEVER

Nuestra tecnología en los cartuchos **ec2** (Econature), **ec3** (Econature+Coldopen) y **Tech Air** (Agua+Aire) está diseñada especialmente para obtener un uso sostenible en el que se evita el gasto innecesario de agua y energía.

VIVENDA TIPO



4 personas que componen el hogar



7 uso aproximado de la **grifería** por persona/día



0,0014 €/L
coste agua fría



0,0052 €/L
coste agua caliente

¿CÓMO LO CALCULAMOS?

4 integrantes de la casa \times **5,8** min de agua por persona $=$ **23,2** min al día por familia \rightarrow **334** litros al día por familia



334 litros de agua al día por familia \times **365** días $=$ **121.764** litros al año por familia \rightarrow **521€** al año
coste de agua/grifería (lavabo, ducha y cocina)

ec2 Econature Air Advanced Water reduce

Consumo de agua
Consumo de energía

213 litros de agua al día por familia \times **365** días $=$ **84.351** litros al año por familia
70% agua caliente / 30% agua fría

339€ al año
coste de agua/grifería (lavabo, ducha y cocina)

AHORRO 35%

ec3 Econature CBI Open Air Advanced Water reduce

Consumo de agua
Consumo de energía

213 litros de agua al día por familia \times **365** días $=$ **84.351** litros al año por familia
50% agua caliente / 50% agua fría

309€ al año
coste de agua+energía/grifería (lavabo, ducha y cocina)

AHORRO 41%

Tiempo de uso/persona/día

LAVABO	2,4
DUCHA	2,8
COCINA	0,6

Tabla de consumos

	L (agua) /min
CONSUMO DUCHA	18
CONSUMO DUCHA TECH AIR	12,6
CONSUMO LAVABO EC1	11
CONSUMO LAVABO EC2	6
CONSUMO LAVABO EC3	6
CONSUMO GRIFO COCINA EC1	11
CONSUMO GRIFO COCINA EC2	6
CONSUMO GRIFO COCINA EC3	6

Los resultados de esta infografía son en base a la tabla de consumos litro de agua por minuto y aplicando solo las variables de grifería para lavabo, ducha y cocina.

CLEVER trabaja con su departamento de I+D para obtener griferías que ahorren agua y energía en nuestro uso diario. Gracias a nuestros cartuchos, aireadores y limitadores de caudal, diseñados especialmente para obtener un uso sostenible, es posible ahorrar agua y cuidar el planeta.

CLEVER is always improving with its R+D department to obtain taps perfectly designed to save water and energy in our daily use.

CLEVER travaille avec son département de R&D pour obtenir une robinetterie qui permet l'économie d'eau et d'énergie au quotidien.

Grâce à nos cartouches, mousseurs et limiteurs de débit, conçus spécialement pour une utilisation durable, il est possible d'économiser l'eau et de prendre soin de notre planète.

Cartuchos

Cartridges / Cartouches

602 Sistema EcoNature
Ahorro de agua G2 NF
Save water / Économie d'eau
 Dos posiciones de apertura de la maneta.
Two positions of opening the handle.
Deux positions d'ouverture de la poignée.

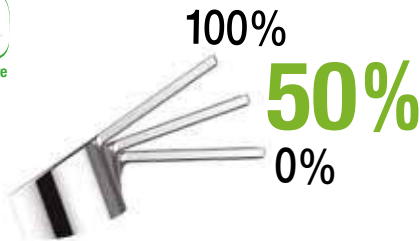

603 Sistema EcoNature+Cold Open
Ahorro de agua y energía G3 NF
Save water and energy / Économie d'eau et d'énergie
 El grifo se abre siempre con agua fría. En la posición central de la maneta se evita la mezcla de agua fría y caliente.
The tap always opens with cold water. In the central position of the handle the mixing of cold and hot water is avoided.
Le robinet s'ouvre toujours avec de l'eau froide. Dans la position centrale de la poignée, le mélange d'eau froide et d'eau chaude est évité.

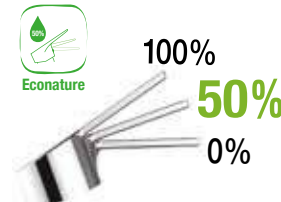

Tech AIR

AIR Technology / Technologie AIR

Los teléfonos y rociadores Clever usan la tecnología AIR Advanced. Inyectando aire antes de la salida del agua, se consigue dar volumen a las gotas reduciendo el consumo de agua hasta un 30%.

Clever Hand showers and Rain showers use the advanced technology AIR Advanced. Mixing air with the incoming water reduces the water consumption at least 30%.

Les douchettes et les pommes de douche Clever sont équipées de la technologie AIR Advanced la plus avancée. L'injection d'air avant la sortie d'eau permet de donner du volume aux gouttes et permet aussi d'économiser jusqu'à 30% de consommation d'eau.

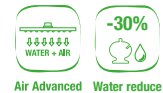

Aireadores

AIR Technology / Technologie AIR



Mezcla aire/agua variable



Permite que el usuario escoja el grado de mezcla aire/agua que necesita sin limitador de caudal.

Allows the user to choose the necessary mixing level air/water without using a flow limiter.

Permet à l'utilisateur de choisir la proportion de mélange air/eau dont il a besoin sans limiteur de débit.

Límite de caudal máximo



Permite limitar el caudal máximo, independientemente de la posición de la maneta, consiguiendo así un mayor ahorro de agua. (No recomendable para grifería de bañera)

To limit the maximum flow rate regardless the handle position, saving more water. (it is not recommended for bath mixers)

Permet de limiter le débit maximum indépendamment de la position de la poignée, obtenant ainsi une économie d'eau supplémentaire (non recommandé pour la robinetterie de baignoire).

¿Qué significa cada certificación?

¿What's the meaning of each certification?
¿Que signifie chaque certification?

1 Adhesión del revestimiento sobre materiales plásticos, choque térmico

Lining adhesion on plastic materials, thermal shock.
Adhésion du recouvrement sur les matériaux plastiques, choc thermique.

Ensayar la adhesión del cromo a los materiales plásticos de la grifería mediante choques térmicos.

Testing the Chrome adhesion on the plastic materials by thermal shocks.

Test d'adhésion du chrome sur les éléments plastiques de la robinetterie par choc thermique.

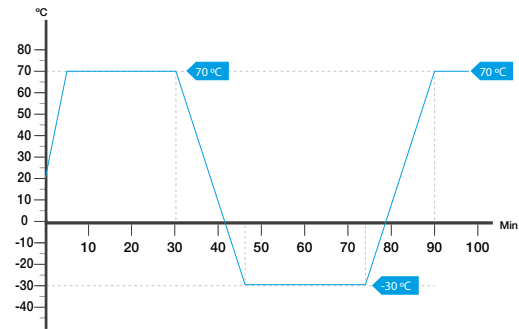

2 Resistencia, niebla salina

Resistance. Salt spray test
Résistance, brouillard salin/acétique

Ensayar la resistencia de los materiales metálicos de la superficie cromada mediante 200 horas bajo el efecto de la niebla salina.

Test the Chrome resistance surface on the metallic materials by checking them on the salt spray test during 200 hours.

Test de durabilité de la surface chromée des éléments métalliques par exposition de 200 h à un brouillard salin.



200h

5% Sal
Salt | Sel

Solución salina 64 con 5% NaCl
Saline 64 with 5% NaCl
Solution saline 64 sur 5% NaCl.

3 Duración mecánica

Mechanic Duration
Durabilité mécanique

Ensayar la duración mecánica de las partes móviles mediante ciclos enteros en cartuchos, caños e inversores.

Test the duration of the mechanical moving parts by cycles on the cartridges, spouts and diverters.

Test d'endurance mécanique des éléments mobiles, cartouches, becs et inverseurs.

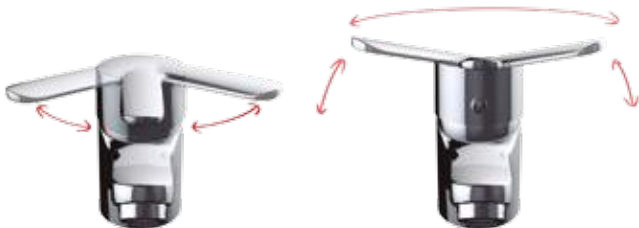

Cartucho/ Cartridge / Cartouche

70.000

Caño / spout / bec

80.000

Inversor / diverter / inverseur

30.000

Cartucho/ Cartridge / Cartouche

175.000

Caño / spout / bec

200.000

Inversor / diverter / inverseur

80.000

4 Resistencia a la presión

Resistance on the pressure
Résistance à la pression

Ensayar la resistencia a la presión sometiendo al cartucho y la grifería un tiempo determinado a una cierta presión

Test the pressure resistance subjecting the cartridge and the mixers during a certain time to a particular pressure.

Test de résistance à la pression en soumettant l'ensemble cartouche/robinet pendant une période de temps déterminé à certaines pressions.



Tiempo / Time / Temps

60s

Presión / Pressure / Pression

25 bars

Repeticiones / Repetitions / Répétitions

100

Presión / Pressure / Pression

50 bars

Proyectos

Projects | Projects

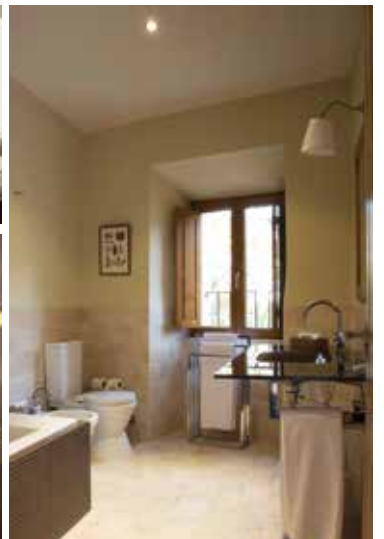
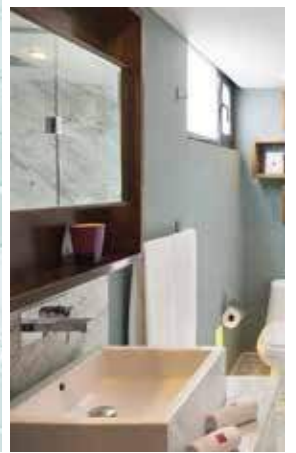

Nuevo contenido web

New web content / Nouveau contenu web



+ Nuevo mapa de distribuidores

para localizar tu punto de venta más cercano.

New distributor map to locate your nearest point of sale.

Nouvelle carte de distributeurs pour localiser votre point de vente le plus proche.

+ Nuevo diseño web

más intuitiva, más contenido (videos, fotos, fichas técnicas, etc) y orientada también a usuario final.

New web design more intuitive, more contents (videos, photos, technical sheets, etc.) and also aimed at the end user.

Nouveau design web plus intuitif, plus de contenu (vidéos, photos, fiches techniques, etc.) et également destiné à l'utilisateur final.



www.griferiaclever.com



+ Nuevo blog Clever

con inspiración, ideas y consejos para tu baño y cocina.

New Clever blog with inspiration, ideas and tips for your bathroom and kitchen.

Nouveau blog Clever avec inspiration, idées et astuces pour votre salle de bain et votre cuisine.



Realidad
Aumentada
Baño y Cocina

Augmented reality
Bath & Kitchen
Réalité Augmentée
Bain et Cuisine





Dónde encontrar
nuestro producto
**Nuevo mapa de
Distribuidores**

Where to find our product.
New distributors map.

Où trouver nos produits.
Nouvelle carte des distributeurs.

Catálogo
de productos

Product catalogue
Catalogue des produits

DESCUBRE TODAS LAS **NOVEDADES** DE NUESTRA **APP CLEVER**

Discover our Clever App / Découvrez notre App Clever



Download Clever App Free



¿Qué significa cada icono?

What's the meaning of each icon? / Que signifie chaque symbole?

Diseño y calidad

Design & Quality | Design et qualité



PATENTED

Diseño exclusivo y patentado
Exclusive and patent design
Design exclusif et breveté



TOP WARRANTY

Garantía calidad 5 años
5 years warranty
Garantie qualité 5 ans

Seguridad

Security | Sécurité



MEDICAL

Máxima higiene
Maximum hygiene
Hygiène maximale



SAFETY BLOCK

Doble tope de seguridad para termostáticos
Double security system for thermostatic
Double système de sécurité pour thermostatique



TERMOLIMIT

Limitación temperatura
Temperature limit
Limitation de la température



THERMOSTATIC

Regulación termostática, alta precisión
Thermostatic control, high precision
Contrôle thermostatique, haute précision

Materiales

Materials | Matériaux



EXTRA BRASS

Latón de alta calidad
High quality brass
Laiton de haute qualité



EXTRA CHROME

Alta calidad cromado
High quality chrome
Chromage haute qualité



MATT

Acabado en mate
Matt finished
Fini mat



STAINLESS STEEL

Grifería de acero inoxidable
Stainless steel taps
Robinetterie acier inox

Medio ambiente

Environment | Environnement



AIR ADVANCED

Mezcla aire y agua
Air and water mixture
Mélange air et eau



ECONATURE

Cartucho C2/ec2 con 2 posiciones
C2/ec2 cartridge with 2 positions
Cartouche C2/ec2 avec 2 positions



PUBLIC PLACE

Diseñado para lugares públicos
Designed for public places
Conçu pour les lieux publics



PURE H₂O

Grifería para osmosis
Filter sink mixer
Robinet eau pure osmosis



WATER REDUCE

Sistema reducción de caudal
Flow reduction system
Système de réduction de débit

Tecnología

Technology | Technologie



CERAMIC CONTROL

Discos cerámicos
Ceramic disc
Disques céramiques



COLD OPEN

Apertura en frío
Cold opening
Ouverture en eau froide



COLD TOUCH

Grifería anti-quemaduras
Anti-scald
Robinetterie anti-brûlures



EASYFIX

Fácil instalación de fregaderos
Easy sink taps installation
Facilité d'installation des éviers



MAGNET

Sistema magnético de sujeción
Magnetic system of subsection
Système magnétique de fixation





























































ORIENTABLE

Aireador orientable
Easy sink taps installation
Aérateur orientable



WATERFALL

Efecto cascada
Waterfall effect
Effet cascade

PLATINUM	Ventu			Accesorios de baño Bathroom accessories Accessoires de salle de bain	
	Aude			iclever	HIDROCLEVER
	Selene			Rociadores Shower heads Pommès de douche	
	Bimini			Brazos rociadores Shower arms Bras de douche	
	Marina Evo			Conjuntos de ducha Shower kits Ensembles de douche	
	Saona Slim			Teléfonos de ducha Handsets Douchettes	
	Paula			Soportes Wall brackets Supports	
	Nine <i>elegance</i>			Barras de ducha Sliding bars Barres de douche	
	Nine <i>xtreme</i>			Flexibles Flexibles Flexibles	
STYLES	Agora <i>elegance</i>			Salidas flexo Wall outlets Sorties flexible	
	Agora <i>xtreme</i>			Caños empotrar Bath Spouts Becs	
	Artic <i>xtreme</i>			Jets hidromasaje Body jets Jets	
	Artic <i>urban</i>			Gama Box	
	Caiman <i>elegance</i>			Chef	COCINA Kitchen Cuisine
	Caiman <i>xtreme</i>			Abatible Folding spout Bec rabattable et orientable	
Caiman <i>urban</i>			Osmosis Osmosis Eau purifiée		
With2 <i>antigona</i>			Platinum		
With2 <i>morea</i>			Styles		
STYLES PRO	Bahama <i>xtreme</i>			Styles Pro	
	Habana <i>xtreme</i>			Gerontológico Medical lever Manette médicale	
	Start <i>elegance</i>			Tratamiento de agua	
	Start <i>xtreme</i>			Temporizados Delay action Temporisés	COLECTIVIDADES Collective spaces Collectivités
	Start <i>urban</i>			Duchas higiénicas Shattafs Douches hygiéniques	
	Panam <i>elegance</i>			Grifos individuales Cold water taps Robinets individuels	
	Panam <i>xtreme</i>			Manetas gerontológicas Medical levers Manettes médicales	
	Panam <i>urban</i>			Termostáticos Thermostats Thermostatiques	
	S12 <i>elegance</i>			Sistemas de ducha Shower and bath-shower systems Colonne douche et bain-douche	
	S12 <i>xtreme</i>			Complementos y Recambios Accessories and spare parts Accessoires et pièces de rechange	
	S12 <i>urban</i>			Expositores Displays Présentoirs	
	With2 <i>guayama</i>			Off Clever	
	Nine <i>urban</i>			Información técnica y Certificados Technical information and certificates Information technique et certificats	
			Índice de referencias y Condiciones de Venta Item directory and Sales conditions Index des références et Conditions de vente		



PLATINUM



Ventu
22



Aude
24



Selene
26



Bimini
28



Marina Evo
34

Conceptual designs to feel your emotions

Live your bathroom



Saona Slim
36



Paula
38



Nine *elegance*
Termostática
Thermostatic / Thermostatique
42



Nine **xtreme**
Termostática
Thermostatic / Thermostatique
44

Ventu

Pura en esencia
Pure essence | Pure essence

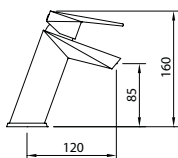

LAVABO 85

Basin mixer 85 | Mitigeur lavabo 85

Mezclador con aireador y flexibles M-10 3/8" x 500 mm.
Mixer, aerator, flexible hoses M-10 3/8" x 500 mm.
Mitigeur lavabo, aérateur, raccords flexibles M-10 3/8" x 500 mm

	Ref.	€	
	ec1 99428	265,00	8



99426 99540 98492

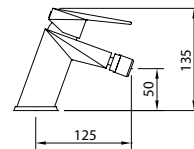

BIDÉ

Bidet mixer | Mitigeur bidet

Mezclador con aireador a rótula, flexibles M-10 3/8" x 420 mm.
Mixer, swivel aerator, flexible hoses M-10 3/8" x 420 mm.
Mitigeur bidet, aérateur, raccords flexibles M-10 3/8" x 420 mm

	Ref.	€	
	ec1 99431	265,00	8



99426 99540 90026

Productos relacionados

Related products
Produits connexes



PAG. 126

iclever basin_98703 + 99718
Lavabo empotrado
Concealed basin mixer
Lavabo encastré



PAG. 237

HYDRA_98675
Válvula desagüe Universal
Universal drain quick-clac
Vidage Universel



PAG. 236

XTREME_96173
Sifón botella latón
Brass bottle trap
Siphon laiton



PAG. 236

BIMINI_97106
Válvula escuadra
Angle Valve
Robinet d'equerre

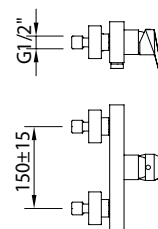
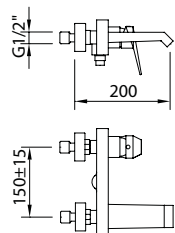
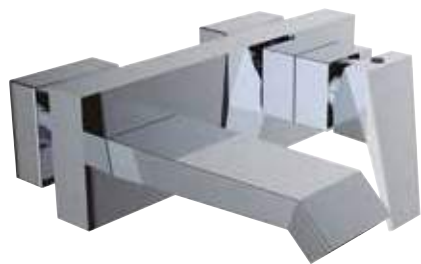

BAÑO-DUCHA
Bath-shower mixer | Mitigeur bain-douche

Mezclador con aireador baño-ducha, inversor integrado.
Bath-shower mixer with aerator, hidden diverter.
Mitigeur bain-douche, aérateur, inverseur intégré

	Ref.	€	
Incluye teléfono ducha, flexo y soporte Includes handset, hose and holder Inclus douchette, flexible et support (98884, 97670, 96413)	ec1 99434	405,00	8

	Ref.	€	
Sin kit ducha Without shower kit Sans kit de douche	ACS ec1 99435	375,00	8

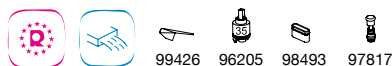

DUCHA
Shower mixer | Mitigeur douche

Mezclador para ducha.
Shower mixer.
Mitigeur douche

	Ref.	€	
Incluye teléfono ducha, flexo y soporte Includes handset, hose and holder Inclus douchette, flexible et support (98884, 97670, 96413)	ec1 99436	360,00	8

	Ref.	€	
Sin kit ducha Without shower kit Sans kit de douche	ACS ec1 99437	330,00	8

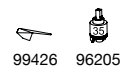

BAÑO DUCHA FIJACIÓN SUELO
Floor standing bath-shower mixer
Mitigeur bain-douche sur colonne avec prise d'eau au sol

Baño-ducha fijación suelo con aireador y inversor automático.
Floor standing bath-shower mixer, with aerator and automatic diverter.
Mitigeur bain-douche sur colonne avec prise d'eau au sol, brise-jet, inverseur automatique



	Ref.	€	
	ec1 99439	885,00	2

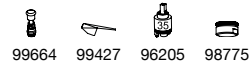

PAG. 112

VENTU_99470
Accesorios de baño
Bathroom accessories
Accessoires de salle de bain



PAG. 128

iclever2_98711 + 99719
Ducha empotrada 1 vía
Concealed bath-shower 1 outlet diverter
Douche encastré 1 voie



PAG. 130

iclever2_98711 + 99720
Ducha empotrada 2 vías
Concealed bath-shower 2 outlet diverter
Douche encastré 2 voie



PAG. 140

TREND_99626
Conjunto barra ducha
Sliding bar set
Ensemble barre douche



PAG. 176

VENTU_99438
Fregadero
Sink mixer
Mitigeur évier

Aude

Espíritu libre
Free spirit | Esprit libre

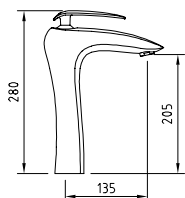

LAVABO 205

Tall basin mixer 205 | Mitigeur lavabo 205

Mezclador alto con aireador y flexibles M-10 3/8" x 370 mm.

Tall mixer, aerator, flexible hoses M-10 3/8" x 370 mm.

Mitigeur Lavabo bec haut, aérateur, raccords flexibles M-10 3/8" x 370 mm

Ref.	€	📦
97811	285,00	6

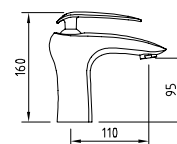

LAVABO 95

Basin mixer 95 | Mitigeur lavabo 95

Mezclador con aireador y flexibles M-10 3/8" x 370 mm.

Mixer, aerator, flexible hoses M-10 3/8" x 370 mm.

Mitigeur Lavabo, aérateur, raccords flexibles M-10 3/8" x 370 mm

Ref.	€	📦
97810	235,00	8

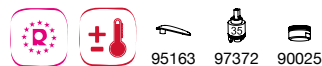

Productos relacionados

Related products
Produits connexes



PAG. 114

elegance _ 99451
Accesorios de baño
Bathroom accessories
Accessoires de salle de bain



PAG. 237

VELA _ 97395 96255
Válvula desagüe metálico
Drain quick-clac metallic
Vidage métallique



PAG. 236

ELEGANCE _ 96174
Sifón botella latón
Brass bottle trap
Siphon laiton



PAG. 236

NEVIS _ 96137
Válvula escuadra
Angle Valve
Robinet d'equerre



BAÑO-DUCHA
Bath-shower mixer | Mitigeur bain-douche

Mezclador con aireador baño- ducha, inversor integrado.
Bath-shower mixer with aerator, hidden diverter.
Mitigeur bain-douche, aérateur, inverseur intégré

	Ref.	€	
Incluye teléfono ducha, flexo y soporte Includes handset, hose and holder Inclus douchette, flexible et support (97142, 97670, 96942)	97813	381,00	6
Sin kit ducha Without shower kit Sans kit de douche	97846	351,00	6

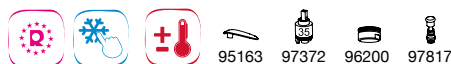

DUCHA
Shower mixer | Mitigeur douche

Mezclador para ducha.
Shower mixer.
Mitigeur douche

	Ref.	€	
Incluye teléfono ducha, flexo y soporte Includes handset, hose and holder Inclus douchette, flexible et support (97142, 97670, 96942)	97814	336,00	6
Sin kit ducha Without shower kit Sans kit de douche	97847	306,00	6

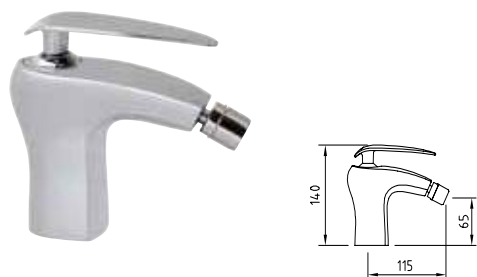

BIDÉ
Bidet mixer | Mitigeur bidet

Mezclador con aireador a rótula, flexibles M-10 3/8" x 370 mm.
Mixer, swivel aerator, flexible hoses M-10 3/8" x 370 mm.
Mitigeur bidet, aérateur rotule, raccords flexibles M-10 3/8" x 370 mm

	Ref.	€	
97812	97812	235,00	6

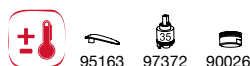

SISTEMA TERMO LIMIT DE LIMITACIÓN DE TEMPERATURA

ThermoLimit system, limits the temperature. Save energy and protect the children to be scalded. / Système Termolimit de limitation de température. Economisez l'énergie et protégez les plus petits des brûlures.



El anillo situado en el cartucho nos permite limitar la apertura lateral de la palanca del grifo.
The ring located in the cartridge allows us to limit the opening of the faucet lever. / Une bague est placée sur la partie supérieure de la cartouche pour limiter l'ouverture latérale de la manette.



iclever 4 _ 98742 + 98750
Ducha empotrada termostática
Thermostatic concealed bath-shower
Douche encastré thermostatique



NINE elegance 60154
Ducha termostática
Thermostatic shower mixer
Mitigeur douche thermostatique



STYLE 99627
Conjunto ducha
Shower kit
Kit douche



AUDE_ 97815
Fregadero
Sink mixer
Mitigeur évier

Selene Inspiración y diseño

Inspiration and design | Inspiration et design

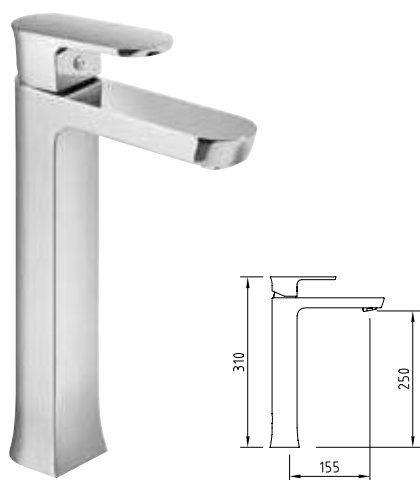

LAVABO 250

Tall basin mixer 250 | Mitigeur lavabo 250

Mezclador alto con aireador y flexibles M-10 3/8" x 370 mm.
Tall mixer, aerator, flexible hoses M-10 3/8" x 370 mm.
Mitigeur Lavabo bec haut, aérateur, raccords flexibles M-10 3/8" x 370 mm.

	Ref.	€	
	ec1 98009	285,00	8

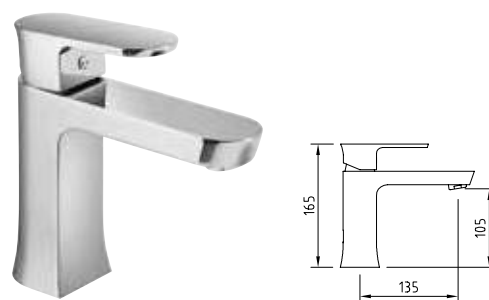

LAVABO 105

Basin mixer 105 | Mitigeur lavabo 105

Mezclador con aireador y flexibles M-10 3/8" x 370 mm.
Mixer, aerator, flexible hoses M-10 3/8" x 370 mm.
Mitigeur Lavabo, aérateur, raccords flexibles M-10 3/8" x 370 mm.

	Ref.	€	
	ec1 98010	235,00	8



Productos relacionados

Related products
Produits connexes



PAG. 112

VENTU _ 99470
Accesorios de baño
Bathroom accessories
Accessoires de salle de bain



PAG. 237

HYDRA _ 98675
Válvula desagüe Universal
Universal drain quick-clac
Vidage Universel



PAG. 236

XTREME _ 96173
Sifón botella latón
Brass bottle trap
Siphon laiton



PAG. 236

NEVIS _ 96137
Válvula escuadra
Angle Valve
Robinet d'equerre



BAÑO-DUCHA
Bath-shower mixer | Mitigeur bain-douche

Mezclador con aireador baño-ducha, inversor automático.
Bath-shower mixer with aerator, automatic diverter.
Mitigeur bain-douche, aérateur, inverseur automatique

	Ref.	€	
Incluye teléfono ducha, flexo y soporte Includes handset, hose and holder Inclus douchette, flexible et support (96786, 97670, 96413)	ec1 98012	381,00	8
Sin kit ducha Without shower kit Sans kit de douche	ACS ec1 98150	351,00	8

- 95168
- 96205
- 90027
- 98008



DUCHA
Shower mixer | Mitigeur douche

Mezclador para ducha.
Shower mixer.
Mitigeur douche

	Ref.	€	
Incluye teléfono ducha, flexo y soporte Includes handset, hose and holder Inclus douchette, flexible et support (96786, 97670, 96413)	ec1 98013	336,00	8
Sin kit ducha Without shower kit Sans kit de douche	ACS ec1 98151	306,00	8

- 95168
- 96205

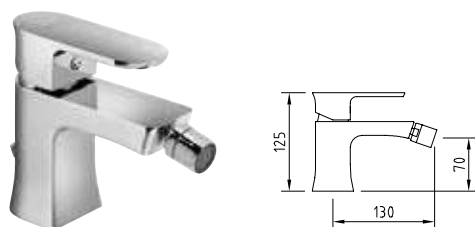

BIDÉ
Bidet mixer | Mitigeur bidet

Mezclador con aireador a rótula, flexibles M-10 3/8" x 370 mm.
Mixer, swivel aerator, flexible hoses M-10 3/8" x 370 mm.
Mitigeur bidet, aérateur rotule, raccords flexibles M-10 3/8" x 370 mm

	Ref.	€	
ACS ec1	98011	235,00	6

- 95168
- 98238
- 90026

MIRROR EFFECT
*Pulido espejo
Mirror Effect
Polissage miroir*

El pulido de la gama Selene se realiza mediante tecnología CNC, obteniendo una planicidad de efecto espejo.

The surface polished for Selene range is produced using the CNC technology, getting perfect flat sides with mirror effect.

L'application de la technologie CNC au dégrossissage et polissage de la gamme Selene permet l'obtention d'une surface plane à effet miroir.



iclever 4 _ 98742 + 98750
*Ducha empotrada termostática
Thermostatic concealed bath-shower
Douche encastré thermostatique*



NINE elegance 60154
*Ducha termostática
Thermostatic shower mixer
Mitigeur douche thermostatique*



TREND_ 99626
*Conjunto barra ducha
Sliding bar set
Ensemble barre douche*



SELENE_ 98014
*Fregadero
Sink mixer
Mitigeur évier*



LAVABO 230

Tall basin mixer 230 | Mitigeur lavabo 230

Mezclador alto, caño giratorio, aireador, flexibles M-10 3/8" x 370 mm.
Tall mixer, aerator, swivel spout, flexible hoses M-10 3/8" x 370 mm.
Mitigeur lavabo haut, bec orientable, aérateur, raccords flexibles M-10 3/8" x 370 mm

	Ref.	€	
	97042	235,00	8



95165 97371 96202

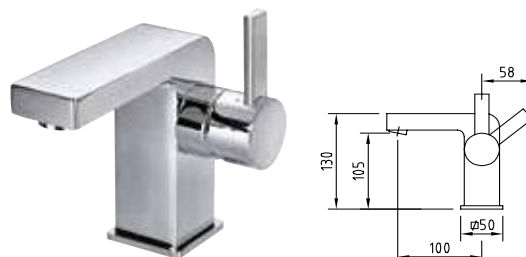

LAVABO 105

Basin mixer 105 | Mitigeur lavabo 105

Mezclador con aireador y flexibles M-10 3/8" x 370 mm.
Mixer, aerator, flexible hoses M-10 3/8" x 370 mm.
Mitigeur Lavabo, aérateur, raccords flexibles M-10 3/8" x 370 mm

	Ref.	€	
	97041	235,00	8



95165 97371 90025

Productos relacionados

Related products
Produits connexes



PAG. 116

XTREME _ 98655
Accesorios de baño
Bathroom accessories
Accessoires de salle de bain



PAG. 237

HYDRA _ 98675
Válvula desagüe Universal
Universal drain quick-clac
Vidage Universel



PAG. 236

XTREME _ 96173
Sifón botella latón
Brass bottle trap
Siphon laiton



PAG. 236

BIMINI _ 97106
Válvula escuadra
Angle Valve
Robinet d'equerre

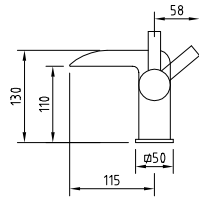

LAVABO 110

Basin mixer 110 | Mitigeur lavabo 110

Mezclador, rompeaguas y flexibles M-10 3/8" x 370 mm.
Mixer, open spout, flexible hoses M-10 3/8" x 370 mm.
Mitigeur lavabo, brise-jet, raccords flexibles M-10 3/8" x 370 mm

	Ref.	€	
	98446	260,00	8



95165 97372

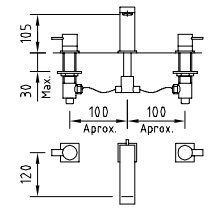

LAVABO REPISA 105

3 hole deck basin 105 | Mélangeur lavabo 105 3 trous

Mezclador repisa, caño con aireador.
Three hole deck basin, spout with aerator.
Mélangeur lavabo 3 trous, aérateur

	Ref.	€	
	97053	280,00	8



95167 90025

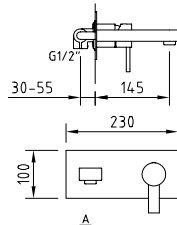

LAVABO EMPOTRAR

Concealed basin | Mitigeur lavabo à encastrer

Mezclador empotrable, caño mural con aireador, longitud 145 mm.
Concealed basin, aerator, wall spout length 145 mm.
Mitigeur lavabo encastré, aérateur, bec 145 mm.

	Ref.	€	
	97059	250,00	8



95178 97370 90025

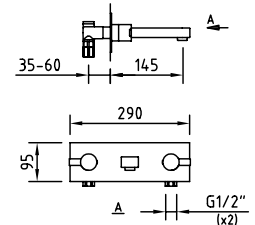

LAVABO EMPOTRAR

Concealed basin | Mélangeur lavabo à encastrer

Mezclador empotrable, caño mural con aireador, longitud 145 mm.
Concealed basin, aerator, wall spout length 145 mm.
Mélangeur lavabo encastré, aérateur, bec 145 mm.

	Ref.	€	
	97054	250,00	4

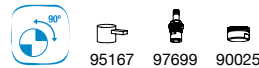

95167 97699 90025



PAG. 128

iclever 2_ 98711 + 98714
Ducha empotrada 1 via
Concealed bath-shower 1 outlet diverter
Douche encastré 1 voie



PAG. 130

iclever 2_ 98711 + 98729
Ducha empotrada 2 vias
Concealed bath-shower 2 outlet diverter
Douche encastré 2 voies



PAG. 145

STYLE AIR_ 99612
Teléfono de ducha
Handset
Douchette



PAG. 177

BIMINI_ 97046
Fregadero
Sink mixer
Mitigeur évier

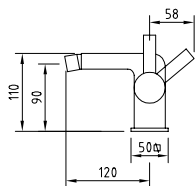

BIDÉ

Bidé mixer | Mitigeur bidet

Mezclador con aireador a rótula y flexibles M-10 3/8" x 370 mm.
Mixer, swivel aerator, flexible hoses M-10 3/8" x 370 mm.
Mitigeur bidet, aérateur rotule, raccords flexibles M-10 3/8" x 370 mm

	Ref.	€	
	97043	235,00	8

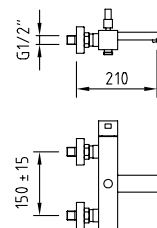
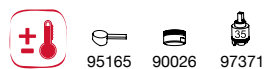

BAÑO-DUCHA

Bath-Shower mixer | Mitigeur bain-douche

Mezclador con aireador baño-ducha, inversor automático.
Bath-shower mixer with aerator, automatic diverter.
Mitigeur bain-douche, aérateur, inverseur automatique

	Ref.	€	
	97044	381,00	4

Sin kit ducha
Without shower kit
Sans kit de douche

	Ref.	€	
	97853	351,00	4

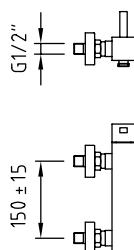

DUCHA

Shower mixer | Mitigeur douche

Mezclador para ducha.
Shower mixer.
Mitigeur douche

	Ref.	€	
	97045	336,00	6

Sin kit ducha
Without shower kit
Sans kit de douche

	Ref.	€	
	97854	306,00	8

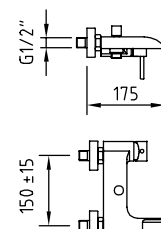
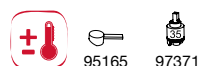

BAÑO-DUCHA

Bath-shower mixer | Mitigeur bain-douche

Mezclador con rompeaguas, inversor automático para baño-ducha.
Bath-shower, open spout mixer with automatic diverter.
Mitigeur bain-douche, brise-jet, inverseur automatique

	Ref.	€	
	98447	406,00	6

Sin kit ducha
Without shower kit
Sans kit de douche

	Ref.	€	
	98785	376,00	6



Productos relacionados

Related products
Produits connexes



XTREME _ 98655
Accesorios de baño
Bathroom accessories
Accessoires de salle de bain



PASCUA _ 97112
Soporte articulado
Articulated holder
Support douchette orientable



iclever 2 _ 98711 + 98714
Ducha empotrada 1 vía
Concealed bath-shower 1 outlet diverter
Douche encastré 1 voie



iclever 2 _ 98711 + 98729
Ducha empotrada 2 vías
Concealed bath-shower 2 outlet diverter
Douche encastré 2 voies

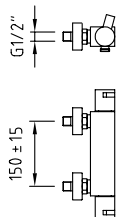

DUCHA TERMOSTÁTICA

Thermostatic Shower mixer | Douche thermostatique

Mezclador termostático para ducha.
Thermostatic shower mixer.
Mitigeur douche thermostatique

Incluye teléfono ducha, flexo y soporte
Includes handset, hose and holder
Inclus douchette, flexible et support
(96412, 97114, 97112)

Ref.	€	
96490	333,00	6

Sin kit ducha
Without shower kit
Sans kit de douche

Ref.	€	
98153	303,00	6

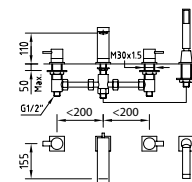

BAÑO-DUCHA REPISA | Four hole deck bath-shower
Mélangeur bain-douche 4 trous

Mezclador repisa, caño con aireador.
Four hole deck bath-shower mixer with aerator.
Mélangeur bain-douche 4 trous, aérateur

Incluye
Includes
Inclus

Ref.	€	
97060	415,00	4

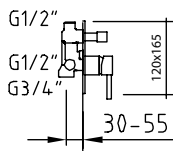
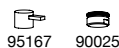
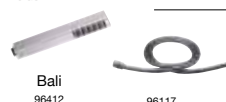

BAÑO-DUCHA EMPOTRAR - 2 VÍAS

Wall mounted bath-shower mixer-2 outlet diverter
Mitigeur à encastrer 2 voies

Mezclador empotrable 1/2" para baño-ducha, inversor automático.
Concealed bath-shower kit 1/2", automatic diverter.
Mitigeur encastré, 1/2", inverseur automatique

Ref.	€	
ec2 97997	218,00	10

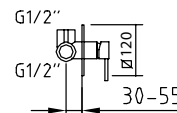
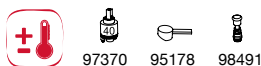

BAÑO-DUCHA EMPOTRAR - 1 VÍA

Wall mounted shower mixer-1 outlet diverter
Mitigeur à encastrer 1 voie

Mezclador empotrable 1/2" para ducha.
Concealed shower kit 1/2".
Mitigeur encastré, 1/2"

Ref.	€	
ec2 97998	160,00	8



PAG. 132

iclever 4 _ 98742 + 98745
Ducha empotrada 3 o 4 vías
Concealed bath-shower 3 or 4 outlet diverter
Douche encastré 3 ou 4 voies



PAG. 148

BIMINI _ 98235
Salida flexo
Wall outlet
Sortie flexible



PAG. 149

BIMINI _ 97999
Caño mural
Bath spout
Bec



PAG. 136

SLIM INOX AIR _ 99688
Rociador
Shower head
Pomme de douche



PAG. 140

TREND _ 99626
Conjunto barra ducha
Sliding bar set
Ensemble barre douche

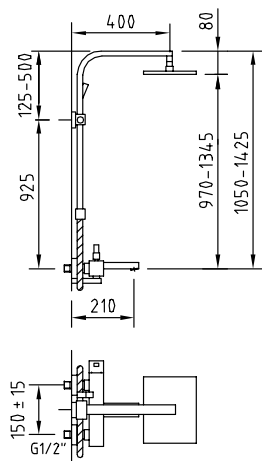

CONJUNTO BAÑO-DUCHA EXTENSIBLE Extensible bath-shower system Colonne mitigeur bain-douche extensible

Mezclador de baño-ducha con tubo extensible.
Extensible bath-shower system.
Support douchette orientable, inverseur automatique, pomme de douche, douchette et flexible.

Incluye
Includes
Inclus



	Ref.	€	
	97055	1.000,00	3

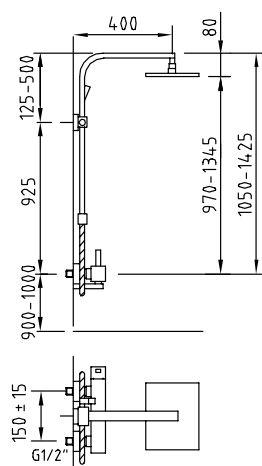
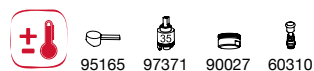

CONJUNTO DE DUCHA EXTENSIBLE Extensible shower system Colonne mitigeur douche extensible

Mezclador de ducha con tubo extensible.
Extensible shower system.
Support douchette orientable, inverseur automatique, pomme de douche, douchette et flexible.

Incluye
Includes
Inclus



	Ref.	€	
	97056	950,00	3

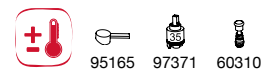

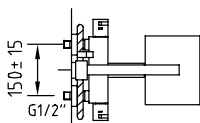
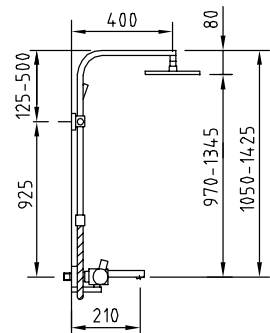

Inversor incorporado en la maneta de caudal
Integral diverter in the flow handle
Inverseur intégré dans la poignée

CONJUNTO DE BAÑO-DUCHA TERMOSTÁTICO EXTENSIBLE
Extensible Thermostatic bath-shower system
Colonne thermostatique bain-douche extensible

Mezclador de baño-ducha **termostático** con tubo extensible.
Adjustable thermostatic bath-shower system.
Support douchette orientable, inverseur automático/cerámico, pomme de douche, douchette et flexible

- Incluye
Includes
Inclus
- 145x200
99686
 - Marina
96786
 - 1,75 m
97670
 - Pascua
97112

Ref.	€	
97057	1.200,00	3

- 98027
- 90027
- 60310

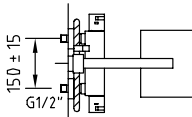
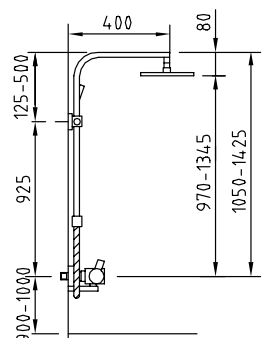

CONJUNTO DE DUCHA TERMOSTÁTICO EXTENSIBLE
Extensible Thermostatic shower system
Colonne thermostatique douche extensible

Mezclador de ducha **termostático** con tubo extensible.
Adjustable thermostatic shower system.
Support douchette orientable, inverseur automático, pomme de douche, douchette et flexible

- Incluye
Includes
Inclus
- 145x200
99686
 - Marina
96786
 - 1,75 m
97670
 - Pascua
97112

Ref.	€	
97058	1.032,00	3

- 98027
- 60310

Productos relacionados
Related products
Produits connexes



PAG. 148

SILVER HOSE _ 98880
Flexible. Acabado en plata
Flexible. Silver finish
Flexible. Finition argent



PAG. 148

FLEXIBLE _ 97114
Cromado
Chrome plated
Chromé



PAG. 145

TREND _ 99609
Teléfono ducha
Handset
Douchette



PAG. 136

SLIM INOX AIR _ 99600
Rociador 200x200
Shower head
Pomme de douche

Marina Evo Fusión de formas

Forms fusion | Fusion des formes

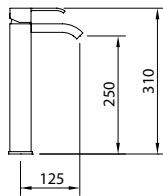

LAVABO 250

Tall basin mixer 250 | Mitigeur lavabo 250

Mezclador alto con aireador y flexibles M-10 3/8" x 370 mm.
Tall mixer, aerator, flexible hoses M-10 3/8" x 370 mm.
Mitigeur Lavabo bec haut, aérateur, raccords flexibles M-10 3/8" x 370 mm

	Ref.	€	
	ec1 99410	258,00	6



99424 99540 99660

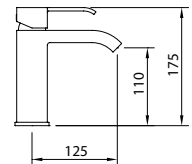

LAVABO 110

Basin mixer 110 | Mitigeur lavabo 110

Mezclador con aireador y flexibles M-10 3/8" x 500 mm.
Mixer, aerator, flexible hoses M-10 3/8" x 500 mm.
Mitigeur lavabo, aérateur, raccords flexibles M-10 3/8" x 500 mm

	Ref.	€	
	ec1 99413	195,00	8



99424 99540 99660

Productos relacionados

Related products
Produits connexes



PAG. 116

XTREME _ 98655
Accesorios de baño
Bathroom accessories
Accessoires de salle de bain



PAG. 237

HYDRA _ 98675
Válvula desagüe Universal
Universal drain quick-clac
Vidage Universel



PAG. 236

XTREME _ 96173
Sifón botella latón
Brass bottle trap
Siphon laiton



PAG. 236

BIMINI _ 97106
Válvula escuadra
Angle Valve
Robinet d'equerre

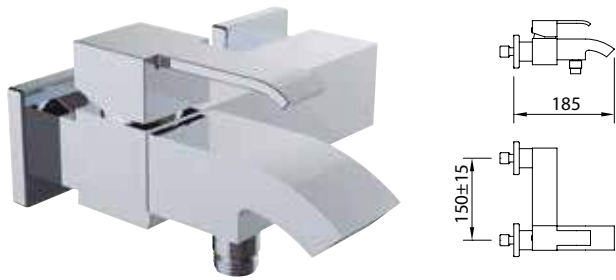

BAÑO-DUCHA

Bath-shower mixer | Mitigeur bain-douche

Mezclador con aireador baño-ducha, inversor integrado.
Bath-shower mixer with aerator, hidden diverter.
Mitigeur bain-douche, aérateur, inverseur intégré

	Ref.	€	
Incluye teléfono ducha, flexo y soporte Includes handset, hose and holder Inclus douche, flexible et support (98884, 97670, 96413)	ec1 99419	335,00	8

	Ref.	€	
Sin kit ducha Without shower kit Sans kit de douche	ec1 99420	305,00	8

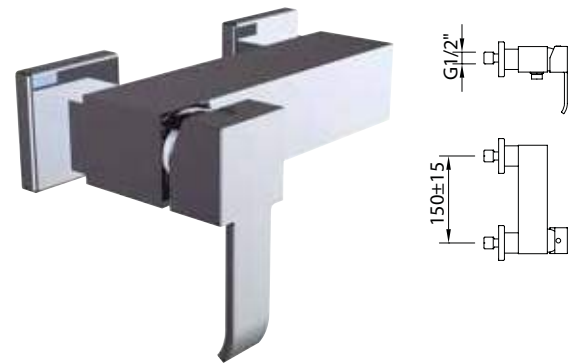

DUCHA

Shower mixer | Mitigeur douche

Mezclador para ducha.
Shower mixer.
Mitigeur douche

	Ref.	€	
Incluye teléfono ducha, flexo y soporte Includes handset, hose and holder Inclus douche, flexible et support (98884, 97670, 96413)	ec1 99421	248,00	8

	Ref.	€	
Sin kit ducha Without shower kit Sans kit de douche	ec1 99422	218,00	8

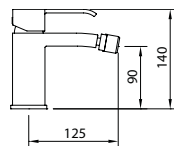

BIDÉ

Bidet mixer | Mitigeur bidet

Mezclador con aireador a rótula, flexibles M-10 3/8" x 420 mm.
Mixer, swivel aerator, flexible hoses M-10 3/8" x 420 mm.
Mitigeur bidet, aérateur rotule, raccords flexibles M-10 3/8" x 420 mm

	Ref.	€	
	ec1 99416	195,00	8



EASYFIX

Fácil instalación de fregaderos
Easy sink taps installation
Facilité d'installation des éviers

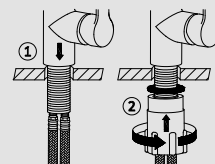

Dispositivo que permite el montaje con la mano, sin la necesidad de emplear herramientas.
Device that allows the assembly by hand, without any tools.
Dispositif permettant un montage sans besoin d'outil spécifique.



PAG. 45

NINE XTREME _ 60133
Ducha termostática
Thermostatic shower mixer
Mitigeur douche thermostatique



PAG. 263

MARINA _ 98444
Ducha empotrada
Concealed bath-shower
Douche encastré



PAG. 140

TREND _ 99626
Conjunto barra ducha
Sliding bar set
Ensemble barre douche



PAG. 177

MARINA EVO _ 99423
Fregadero
Sink mixer
Mitigeur évier

Saona Slim

Lineas puras
Pure lines | Lignes pures



LAVABO 250
Tall basin mixer 250 | Mitigeur lavabo 250

Mezclador con aireador y flexibles M-10 3/8" x 370 mm.
Mixer, aerator, flexible hoses M-10 3/8" x 370 mm.
Mitigeur Lavabo, aérateur, raccords flexibles M-10 3/8" x 370 mm

Ref.	€	
ACS ec1 60118	192,00	8

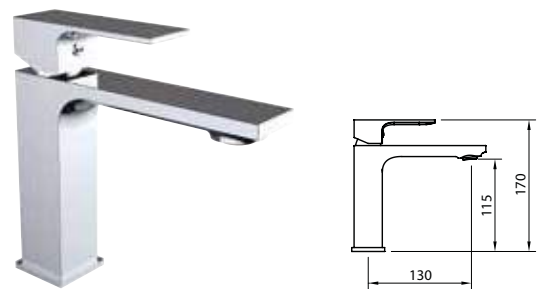

LAVABO 115
Basin mixer 115 | Mitigeur lavabo 115

Mezclador con aireador y flexibles M-10 3/8" x 500 mm.
Mixer, aerator, flexible hoses M-10 3/8" x 500 mm.
Mitigeur Lavabo, aérateur, raccords flexibles M-10 3/8" x 500 mm

Ref.	€	
ACS ec1 60115	142,00	8

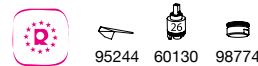

Productos relacionados

Related products
Produits connexes



PAG. 116

XTREME _ 98655
Accesorios de baño
Bathroom accessories
Accessoires de salle de bain



PAG. 237

HYDRA _ 98675
Válvula desagüe Universal
Universal drain quick-clac
Vidage Universel



PAG. 236

XTREME _ 96173
Sifón botella latón
Brass bottle trap
Siphon laiton



PAG. 236

BIMINI _ 97106
Válvula escuadra
Angle Valve
Robinet d'equerre



BAÑO-DUCHA
Bath-shower mixer | Mitigeur bain-douche

Mezclador baño-ducha, aireador, inversor automático.
Bath-shower mixer, aerator, automatic diverter.
Mitigeur bain-douche, aérateur, inverseur automatique

	Ref.	€	8
Incluye teléfono ducha, flexo y soporte Includes handset, hose and holder Inclus douchette, flexible et support (98884, 97670, 96413)	ec1 60124	230,00	8
Sin kit ducha Without shower kit Sans kit de douche	ACS ec1 60125	200,00	8



DUCHA
Shower mixer | Mitigeur douche

Mezclador para ducha.
Shower mixer.
Mitigeur douche

	Ref.	€	8
Incluye teléfono ducha, flexo y soporte Includes handset, hose and holder Inclus douchette, flexible et support (98884, 97670, 96413)	ec1 60126	195,00	8
Sin kit ducha Without shower kit Sans kit de douche	ACS ec1 60127	165,00	8

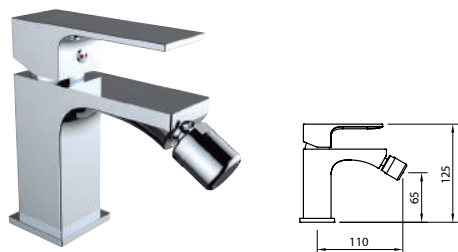

BIDÉ
Bidet mixer | Mitigeur bidet

Mezclador con aireador a rótula, flexibles M-10 3/8" x 420 mm.
Mixer, swivel aerator, flexible hoses M-10 3/8" x 420 mm.
Mitigeur bidet, aérateur rotule, raccords flexibles M-10 3/8" x 420 mm

	Ref.	€	8
ACS ec1 60121	142,00	8	



AIREADOR ORIENTABLE
para un mayor confort durante su uso

Orientable aerator for greater comfort during its use
Aérateur orientable pour plus de confort lors de l'utilisation

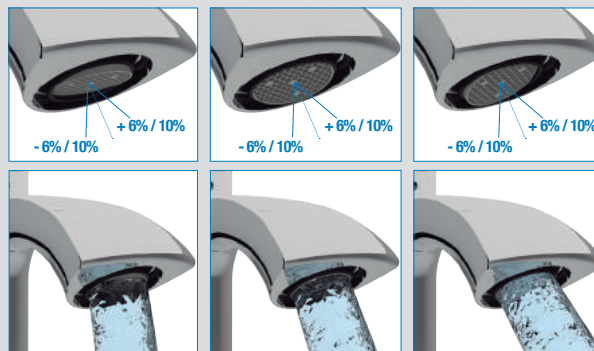

NINE XTREME _ 60133
Ducha termostática
Thermostatic shower mixer
Mitigeur douche thermostatique



MARINA _ 98444
Ducha empotrada
Concealed bath-shower
Douche encastré



TREND _ 99626
Conjunto barra ducha
Sliding bar set
Ensemble barre douche



SAONA SLIM _ 60128
Fregadero
Sink mixer
Mitigeur évier

Paula Estilo propio Own style | Style unique

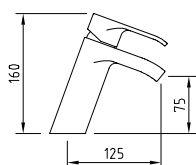

LAVABO 75 Basin mixer 75 | Mitigeur lavabo 75

Mezclador con aireador y flexibles M-10 3/8" x 370 mm.
Mixer, aerator, flexible hoses M-10 3/8" x 370 mm.
Mitigeur Lavabo, aérateur, raccords flexibles M-10 3/8" x 370 mm

	Ref.	€	
	ec1 98197	142,00	8



98215 98238 98492

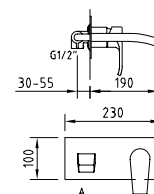

LAVABO A EMPOTRAR Concealed basin mixer | Lavabo à encastrer

Mezclador empotrable, caño mural con aireador, longitud 190 mm.
Concealed basin, aerator, wall spout length 190 mm.
Mélangeur lavabo encastré, aérateur, bec 190 mm.

	Ref.	€	
	ec1 98413	210,00	6

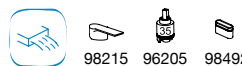

98215 96205 98492

Productos relacionados Related products Produits connexes



PAG. 114

elegance _ 99451
Accesorios de baño
Bathroom accessories
Accessoires de salle de bain



PAG. 237

VELA _ 97395 96255
Válvula desagüe metálico
Drain quick-clac metallic
Vidage métallique



PAG. 236

ELEGANCE _ 96174
Sifón botella latón
Drain quick-clac metallic
Siphon laiton



PAG. 236

NEVIS _ 96137
Válvula escuadra
Angle Valve
Robinet d'equerre



BAÑO-DUCHA
Bath-shower mixer | Mitigeur bain-douche

Mezclador baño-ducha, aireador, inversor automático.
Bath-shower mixer, aerator, automatic diverter.
Mitigeur bain-douche, aérateur, inverseur automatique

	Ref.	€	
Incluye teléfono ducha, flexo y soporte Includes handset, hose and holder Inclus douchette, flexible et support (96786, 97670, 96413)	ec1 98199	213,00	6
Sin kit ducha Without shower kit Sans kit de douche	ACS ec1 98539	183,00	6

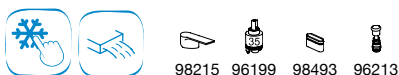

DUCHA
Shower mixer | Mitigeur douche

Mezclador para ducha.
Shower mixer.
Mitigeur douche

	Ref.	€	
Incluye teléfono ducha, flexo y soporte Includes handset, hose and holder Inclus douchette, flexible et support (96786, 97670, 96413)	ec1 98200	168,00	6
Sin kit ducha Without shower kit Sans kit de douche	ACS ec1 98540	138,00	6

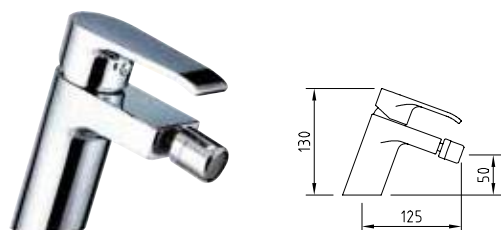

BIDÉ
Bidet mixer | Mitigeur bidet

Mezclador con aireador a rótula, flexibles M-10 3/8" x 370 mm.
Mixer, swivel aerator, flexible hoses M-10 3/8" x 370 mm.
Mitigeur bidet, aérateur rotule, raccords flexibles M-10 3/8" x 370 mm

	Ref.	€	
	ec1 98198	142,00	8



DESMONTAJE AIREADOR ENRASADO
Aerator dismantling - Démontage aérateur caché



Iclever 2_ 98711+98716
Ducha empotrada 1 vía
Concealed bath-shower 1 outlet diverter
Douche encastré 1 voie



Iclever 2_ 98711+98731
Ducha empotrada 2 vías
Concealed bath-shower 2 outlet diverter
Douche encastré 2 voies



STYLE_ 99627
Conjunto ducha
Shower kit
Kit douche



PAULA_ 98201
Fregadero
Sink mixer
Mitigeur évier

Paula

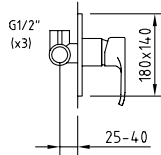

DUCHA EMPOTRAR / 1 VÍA | Wall mounted shower mixer / 1 outlet diverter | Mitigeur à encastrer / 1 voie

Mezclador empotrable de 1/2" para ducha.
Concealed shower set 1/2".
Mitigeur encastré, 1/2"

Ref.	€	
ec1 98417	105,00	12



98215 96205

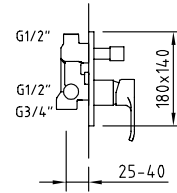

BAÑO-DUCHA EMPOTRAR / 2 VÍAS | Wall mounted bath-shower mixer / 2 outlet diverter | Mitigeur à encastrer / 2 voies

Mezclador empotrable de 1/2" para baño-ducha, inversor automático.
Concealed bath-shower set 1/2", automatic diverter.
Mitigeur encastré, 1/2", inverseur automatique

Ref.	€	
ec1 98416	144,00	12



98215 96205 98491

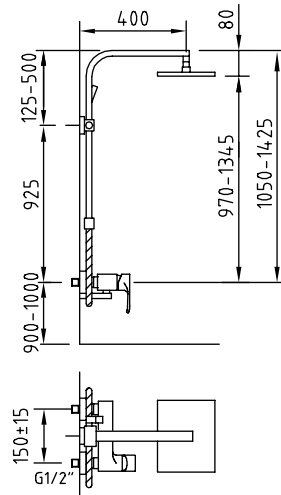

CONJUNTO DE DUCHA EXTENSIBLE | Shower system | Colonne mitigeur douche extensible

Mezclador de ducha con tubo extensible.
Adjustable shower system.
Support douchette orientable, inverseur automatique, pomme de douche, douchette et flexible

Incluye
Includes
Inclus

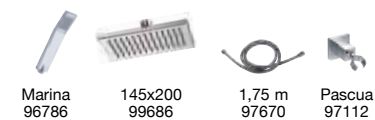

Ref.	€	
ec1 98415	700,00	4

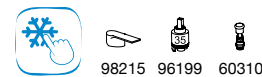

98215 96199 60310

Productos relacionados Related products Produits connexes



PAG. 136

SLIM INOX AIR _ 99601
Rociador 400x250mm
Shower head
Pomme de douche



PAG. 142

LUZIA _ 96153
Brazo rociador
Shower arm
Bras de douche



PAG. 145

STYLE AIR _ 99612
Teléfono de ducha
Handset
Douchette



PAG. 148

CAIMAN urban _ 98236
Salida flexo mural con soporte
Wall hose bib outlet with holder
Sortie flexible murale avec support



98197 | Lavabo
Basin Mixer
Mitiger Lavabo

98415 | Conjunto de ducha extensible
Shower system
Colonne mitigeur douche extensible



Nine elegance



TERMOSTÁTICA
Thermostatic/Thermostatique

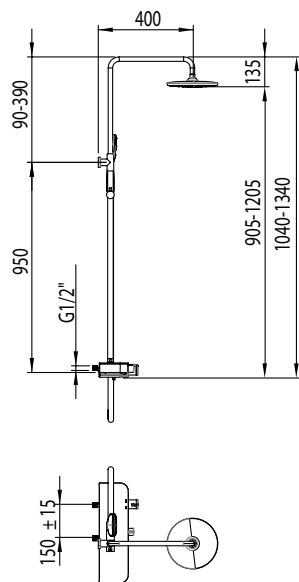
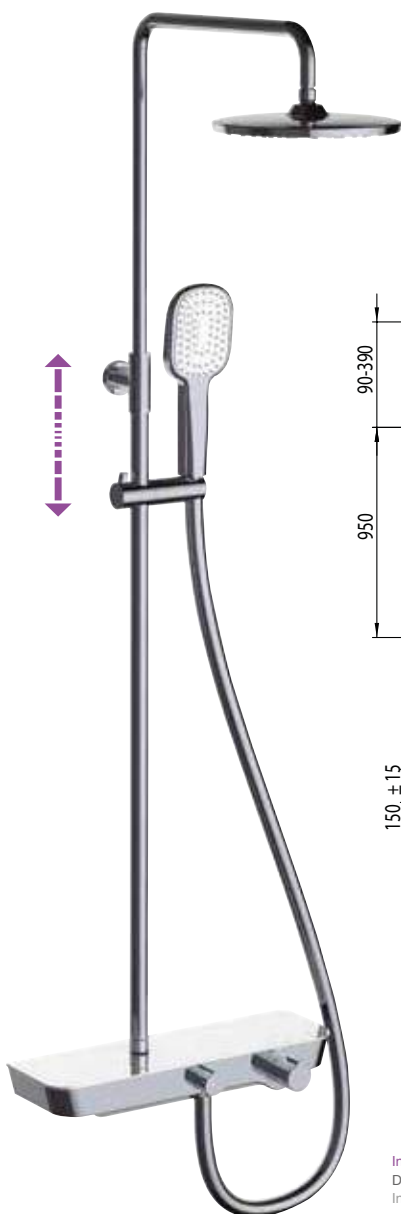

CONJUNTO DE DUCHA EXTENSIBLE TERMOSTÁTICO |
Thermostatic Extensible shower system | Colonne de douche extensible thermostatique

Mezclador termostático de ducha con tubo extensible (98517), soporte articulado deslizando.
Adjustable thermostatic shower system (98517) with diverter built in.
Support douchette coulissant, inverseur céramique, pomme de douche, douchette et flexible

Incluye
Includes
Inclus



Ref.	€	Q
99731	575,00	4

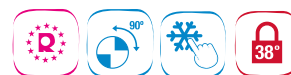
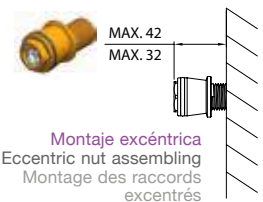

Inversor incorporado en la maneta de caudal
Diverter built in the flow handle
Inverseur intégré dans la poignée

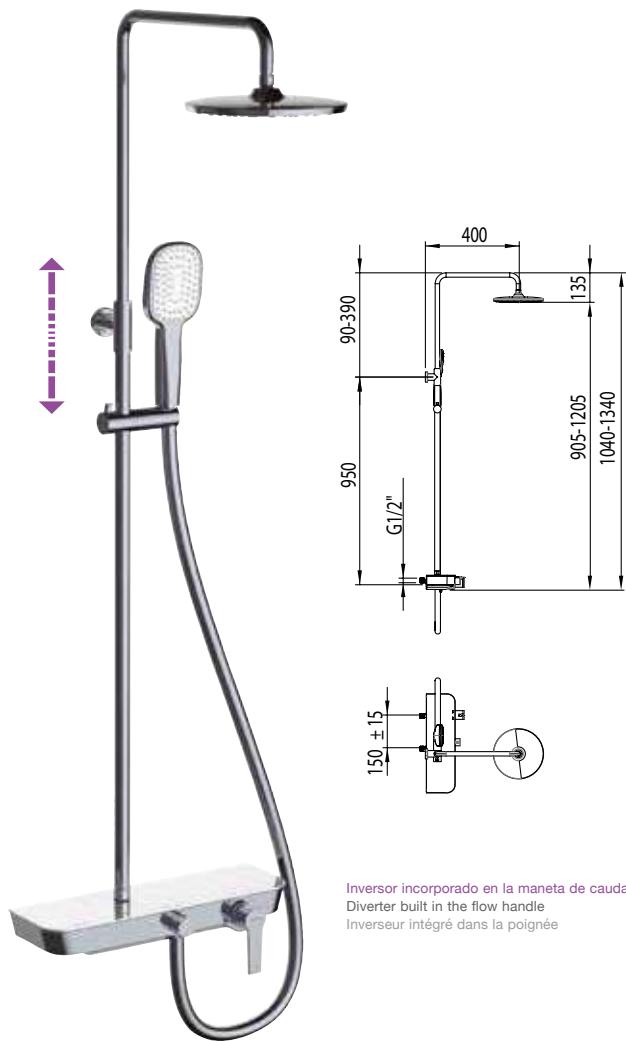

CONJUNTO DE DUCHA EXTENSIBLE | Extensible shower system | Colonne de douche extensible

Mezclador de ducha con tubo extensible Circular (98517), soporte articulado deslizable.
Adjustable shower valve with diverter built in.
Support douchette coulissant, inverseur automatique, pomme de douche, douchette et flexible

Incluye
Includes
Inclus



Ref.	€	Q
99732	500,00	4

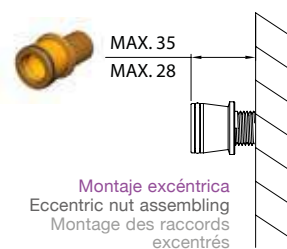

Montaje excéntrica
Eccentric nut assembling
Montage des raccords excentrés

Inversor incorporado en la maneta de caudal
Diverter built in the flow handle
Inverseur intégré dans la poignée



DUCHA TERMOSTÁTICA | Thermostatic shower mixer | Mitigeur douche thermostatique

Mezclador termostático para ducha.
Thermostatic shower mixer.
Mitigeur douche thermostatique

Incluye
Includes
Inclus



Ref.	€	Q
60154	370,00	4



Montaje excéntrica
Eccentric nut assembling
Montage des raccords excentrés

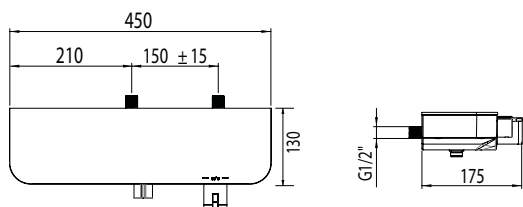
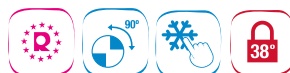

Productos relacionados
Related products
Produits connexes



PAG. 148

FLEXIBLE_ 97114
Cromado
Chrome plated
Chromé



PAG. 143

STYLE_ 99610
Teléfono ducha
Handset
Douchette



PAG. 136

SLIM INOX AIR_ 99600
Rociador 200x200
Shower head
Pomme de douche

Nine xtreme



TERMOSTÁTICA
Thermostatic/Thermostatique

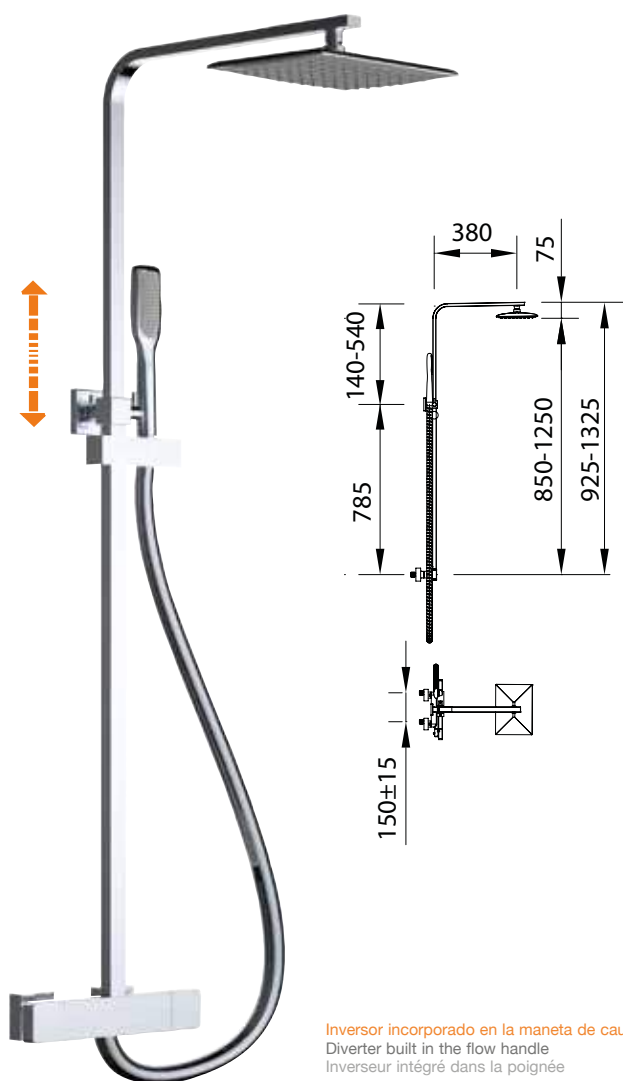

CONJUNTO DE DUCHA EXTENSIBLE TERMOSTÁTICO
Thermostatic Extensible shower system
Colonne de douche extensible thermostatique

Incluye
Includes
Inclus



Ref.	€	
60135	495,00	4



Inversor incorporado en la maneta de caudal
Diverter built in the flow handle
Inverseur intégré dans la poignée

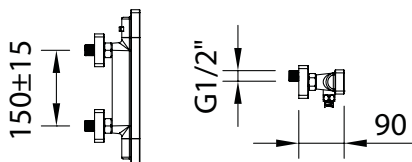

DUCHA TERMOSTÁTICA
Thermostatic shower mixer
Mitigeur douche thermostatique

Mezclador para ducha.
 Shower mixer.
 Mitigeur douche thermostatique

- Incluye
Includes
Inclus
- Trend
55x100
99609
- Silver Hose
1,75 m
98880
- Start
60311

	Ref.	€	📦
Incluye Kit ducha Includes shower kit Inclus kit de douche	60133	280,00	6
Sin kit ducha Without shower kit Sans kit de douche	60134	250,00	6

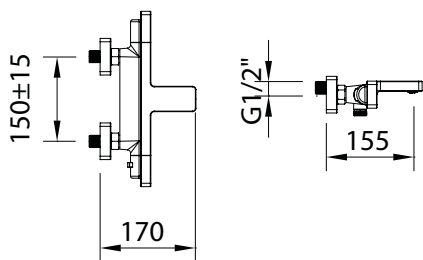

BAÑO-DUCHA TERMOSTÁTICO
Thermostatic bath-shower mixer
Mitigeur bain-douche thermostatique

Mezclador baño-ducha, aireador y inversor
 Bath-shower mixer, aerator and diverter built in.
 Mitigeur bain-douche thermostatique, aérateur et inverseur

- Incluye
Includes
Inclus
- Trend
55x100
99609
- Silver Hose
1,75 m
98880
- Start
60311

	Ref.	€	📦
Incluye Kit ducha Includes shower kit Inclus kit de douche	60131	330,00	6
Sin kit ducha Without shower kit Sans kit de douche	60132	300,00	6



Inversor incorporado en la maneta de caudal
 Diverter built in the flow handle
 Inverseur intégré dans la poignée

Productos relacionados
 Related products
 Produits connexes



PAG. 148

FLEXIBLE_ 97114
 Cromado
 Chrome plated
 Chromé



PAG. 145

MARINA_ 96786
 Teléfono ducha
 Handset
 Douchette



PAG. 136

SLIM INOX AIR_ 99600
 Rociador 200x200
 Shower head
 Pomme de douche



STYLES



Agora *elegance*
48



Agora *xtreme*
50



Artic *xtreme*
52



Artic *urban*
54

Unlimited emotions

Unlimited designs



Caiman *elegance*
56



Caiman *xtreme*
60



Caiman *urban*
62



With2 *antigona*
64



With2 *morea*
68

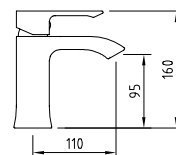
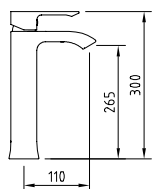

LAVABO 265

Tall basin mixer 265 | Mitigeur lavabo 265

Mezclador con aireador y flexibles M-10 3/8" x 370 mm.
Mixer, aerator, flexible hoses M-10 3/8" x 370 mm.
Mitigeur Lavabo bec haut, aérateur, raccords flexibles M-10 3/8" x 370 mm

	Ref.	€	📦
	98783	177,00	6



LAVABO 95

Basin mixer 95 | Mitigeur lavabo 95

Mezclador con aireador y flexibles M-10 3/8" x 420 mm.
Mixer, aerator, flexible hoses M-10 3/8" x 420 mm.
Mitigeur Lavabo, aérateur, raccords flexibles M-10 3/8" x 420 mm

	Ref.	€	📦
	98680	135,00	12

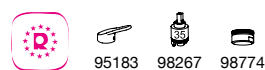

Productos relacionados

Related products
Produits connexes



PAG. 126

iclever basin 98703 + 98709
Lavabo empotrado
Concealed basin mixer
Lavabo encastré



PAG. 237

VELA _ 97395 96255
Válvula desagüe metálico
Drain quick-clac metallic
Vidage métallique



PAG. 236

ELEGANCE _ 96174
Sifón botella latón
Brass bottle trap
Siphon laiton



PAG. 236

DESIGN _ 40010
Válvula escuadra
Angle Valve / Robinet
d'équerre

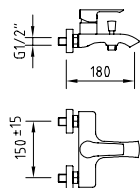

BAÑO-DUCHA

Bath-shower mixer | Mitigeur bain-douche

Mezclador con aireador baño-ducha, inversor automático.
Bath-shower mixer with aerator, automatic diverter.
Mitigeur bain-douche, aérateur, inverseur automatique

Incluye teléfono ducha, flexo y soporte
Includes handset, hose and holder
Inclus douchette, flexible et support
(97142, 97670, 96942)

	Ref.	€	
	98682	186,00	8

Sin kit ducha
Without shower kit
Sans kit de douche

	Ref.	€	
	98678	166,00	8



- 95183
- 97371
- 98775
- 98008

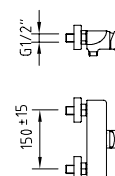

DUCHA

Shower mixer | Mitigeur douche

Mezclador para ducha.
Shower mixer.
Mitigeur douche

Incluye teléfono ducha, flexo y soporte
Includes handset, hose and holder
Inclus douchette, flexible et support
(97142, 97670, 96942)

	Ref.	€	
	98683	156,00	8

Sin kit ducha
Without shower kit
Sans le kit de douche

	Ref.	€	
	98679	136,00	8

- 95183
- 97371

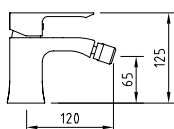

BIDÉ

Bidet mixer | Mitigeur bidet

Mezclador con aireador a rótula, flexibles M-10 3/8" x 420 mm.
Mixer, swivel aerator, flexible hoses M-10 3/8" x 420 mm.
Mitigeur bidet, aérateur rotule, raccords flexibles M-10 3/8" x 420 mm

	Ref.	€	
	98681	135,00	12

- 95183
- 98267
- 90026

AIREADOR ORIENTABLE
para un mayor confort durante su uso

Orientable aerator for greater comfort during its use
Aérateur orientable pour plus de confort lors de l'utilisation

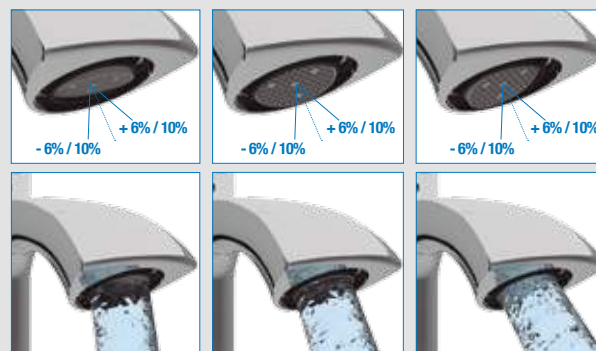

PAG. 114

elegance _ 99451
Accesorios de baño
Bathroom accessories
Accessoires de salle de bain



PAG. 128

iclever2 _ 98711 + 98720
Ducha empotrada 1 via
Concealed bath-shower 1 outlet diverter
Douche encastré 1 voie



PAG. 130

iclever2 _ 98711 + 98735
Ducha empotrada 2 vias
Concealed bath-shower 2 outlet diverter
Douche encastré 2 voie



PAG. 140

STYLE_ 99627
Conjunto ducha
Shower kit
Kit douche



PAG. 180

AGORA elegance_ 98684
Fregadero
Sink mixer
Mitigeur évier

Agora xtreme



LAVABO 240

Tall basin mixer 240 | Mitigeur lavabo 240

Mezclador con aireador y flexibles M-10 3/8" x 370 mm.
Mixer, aerator, flexible hoses M-10 3/8" x 370 mm.
Mitigeur Lavabo, aérateur, raccords flexibles M-10 3/8" x 370 mm

	Ref.	€	
	60103	167,00	8

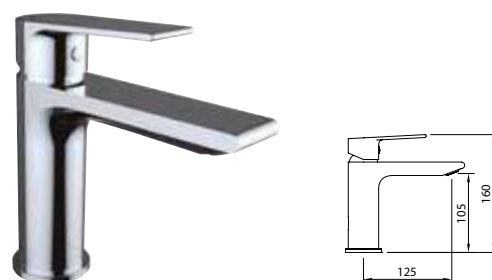
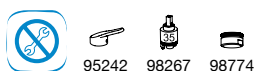

LAVABO 105

Basin mixer 105 | Mitigeur lavabo 105

Mezclador con aireador y flexibles M-10 3/8" x 420 mm.
Mixer, aerator, flexible hoses M-10 3/8" x 420 mm.
Mitigeur Lavabo, aérateur, raccords flexibles M-10 3/8" x 420 mm

	Ref.	€	
	60100	125,00	8



Productos relacionados Related products Produits connexes



PAG. 116

xtreme _ 98655
Accesorios de baño
Bathroom accessories
Accessoires de salle de bain



PAG. 237

HYDRA _ 98675
Válvula desagüe Universal
Universal drain quick-clac
Vidage Universel



PAG. 236

XTREME _ 96173
Sifón botella latón
Brass bottle trap
Siphon laiton



PAG. 236

XTREME _ 97106
Válvula escuadra
Angle Valve / Robinet
d'equerre



BAÑO-DUCHA
Bath-shower mixer | Mitigeur bain-douche

Mezclador con aireador baño-ducha, inversor automático.
Bath-shower mixer with aerator, automatic diverter.
Mitigeur bain-douche, aérateur, inverseur automatique

Incluye teléfono ducha, flexo y soporte
Includes handset, hose and holder
Inclus douchette, flexible et support
(97142, 97670, 60311)

	Ref.	€	
	60109	176,00	8
	60110	156,00	8

Sin kit ducha
Without shower kit
Sans kit de douche

- 95242
- 97371
- 98775
- 60114



DUCHA
Shower mixer | Mitigeur douche

Mezclador para ducha.
Shower mixer.
Mitigeur douche

Incluye teléfono ducha, flexo y soporte
Includes handset, hose and holder
Inclus douchette, flexible et support
(97142, 97670, 60311)

	Ref.	€	
	60111	146,00	8
	60112	126,00	8

Sin kit ducha
Without shower kit
Sans kit de douche

- 95242
- 99227

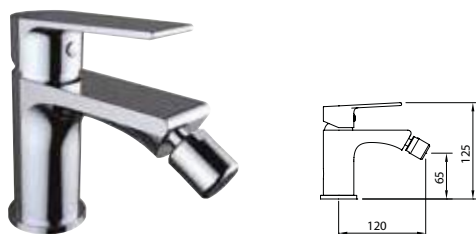

BIDÉ
Bidet mixer | Mitigeur bidet

Mezclador con aireador a rótula, flexibles M-10 3/8" x 370 mm.
Mixer, swivel aerator, flexible hoses M-10 3/8" x 370 mm.
Mitigeur bidet, aérateur rotule, raccords flexibles M-10 3/8" x 370 mm

	Ref.	€	
	60106	125,00	8

- 95242
- 98267
- 99232

AIREADOR ORIENTABLE
para un mayor confort durante su uso

Orientable aerator for greater comfort during its use
Aérateur orientable pour plus de confort lors de l'utilisation

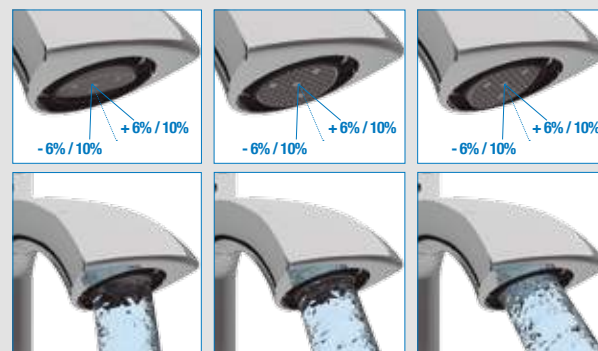

TREND_99626
Conjunto barra ducha
Sliding bar set
Ensemble barre douche

AGORA xtreme_60113
Fregadero
Sink mixer
Mitigeur évier



iclever 4_98742 + 98750
Ducha empotrada termostática
Thermostatic concealed bath-shower
Douche encastré thermostatique



NINE XTREME_60133
Ducha termostática
Thermostatic shower mixer
Mitigeur douche thermostatique



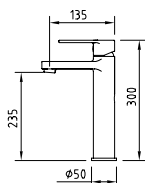

Artic xtreme



LAVABO 235

Tall basin mixer 235 | Mitigeur lavabo 235

Mezclador con aireador y flexibles M-10 3/8" x 370 mm.
Mixer, aerator, flexible hoses M-10 3/8" x 370 mm.
Mitigeur Lavabo bec haut, aérateur, raccords flexibles M-10 3/8" x 370 mm



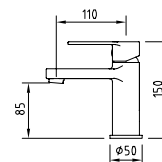

	Ref.	€	📦
   	98784	147,00	6



LAVABO 85

Basin mixer 85 | Mitigeur lavabo 85

Mezclador con aireador y flexibles M-10 3/8" x 420 mm.
Mixer, aerator, flexible hoses M-10 3/8" x 420 mm.
Mitigeur Lavabo, aérateur, raccords flexibles M-10 3/8" x 420 mm

	Ref.	€	📦
   	98690	107,00	12

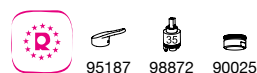

Productos relacionados

Related products
Produits connexes



PAG. 126

iclever basin _ 98703 + 98710
Lavabo empotrado
Concealed basin mixer
Lavabo encastré



PAG. 237

VELA _ 97395 96255
Válvula desagüe metálico
Drain quick-clac metallic
Vidage métallique



PAG. 236

ELEGANCE _ 96174
Sifón botella latón
Brass bottle trap
Siphon laiton



PAG. 236

DESIGN _ 40010
Válvula escuadra
Angle Valve / Robinet
d'equerre

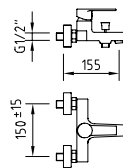

BAÑO-DUCHA
Bath-shower mixer | Mitigeur bain-douche

Mezclador baño-ducha, aireador, inversor automático
Bath-shower mixer, aerator, automatic diverter.
Mitigeur bain-douche, aérateur, inverseur automatique

Incluye teléfono ducha, flexo y soporte
Includes handset, hose and holder
Inclus douchette, flexible et support
(90796, 97670, 98208)

	Ref.	€	
	98692	153,00	8

Sin kit ducha
Without shower kit
Sans kit de douche

	Ref.	€	
	98699	133,00	8

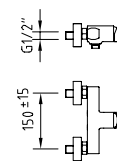
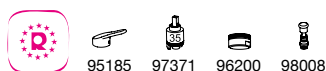

DUCHA
Shower mixer | Mitigeur douche

Mezclador para ducha.
Shower mixer.
Mitigeur douche

Incluye teléfono ducha, flexo y soporte
Includes handset, hose and holder
Inclus douchette, flexible et support
(90796, 97670, 98208)

	Ref.	€	
	98693	123,00	8

Sin kit ducha
Without shower kit
Sans kit de douche

	Ref.	€	
	98700	103,00	8

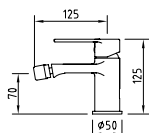

BIDÉ
Bidet mixer | Mitigeur bidet

Mezclador con aireador a rótula y flexibles M-10 3/8" x 420 mm.
Mixer, swivel aerator, flexible hoses M-10 3/8" x 420 mm.
Mitigeur bidet, aérateur rotule, raccords flexibles M-10 3/8" x 420 mm

	Ref.	€	
	98691	107,00	12



SISTEMA COLD OPEN DE APERTURA EN FRÍO. AHORRA EN AGUA CALIENTE.

Cold Open system. It opens in cold position. You save energy.

Cold Open. Système d'ouverture en eau froide pour faire des économies d'énergie.



PAG. 118

Urban_99459
Accesorios de baño
Bathroom accessories
Accessoires de salle de bain



PAG. 128

Iclever 2_98711+98721
Ducha empotrada 1 vía
Concealed bath-shower 1 outlet diverter
Douche encastré 1 voie



PAG. 130

Iclever 2_98711+98736
Ducha empotrada 2 vías
Concealed bath-shower 2 outlet diverter
Douche encastré 2 voies



PAG. 140

Style_99627
Conjunto ducha
Shower kit
Kit douche



PAG. 181

Artic Xtreme_98694
Fregadero
Sink mixer
Mitigeur évier

Artic urban

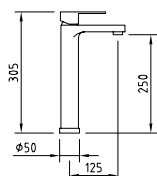

LAVABO 250

Tall basin mixer 250 | Mitigeur lavabo 250

Mezclador con aireador y flexibles M-10 3/8" x 600 mm.
Mixer, aerator, flexible hoses M-10 3/8" x 600 mm.
Mitigeur Lavabo bec haut, aérateur, raccords flexibles M-10 3/8" x 600 mm

	Ref.	€	
	ec1 98103	169,00	12

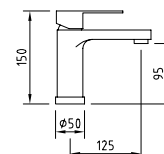

LAVABO 95

Basin mixer 95 | Mitigeur lavabo 95

Mezclador con aireador y flexibles M-10 3/8" x 420 mm.
Mixer, aerator, flexible hoses M-10 3/8" x 420 mm.
Mitigeur Lavabo, aérateur, raccords flexibles M-10 3/8" x 420 mm

	Ref.	€	
	ec1 98102	127,00	12



Productos relacionados

Related products
Produits connexes



PAG. 118

urban _ 99459
Accesorios de baño
Bathroom accessories
Accessoires de salle de bain



PAG. 237

VELA _ 97395_96255
Válvula desagüe metálico
Drain quick-clac metallic
Vidage métallique



PAG. 236

ELEGANCE _ 96174
Sifón botella latón
Brass bottle trap
Siphon laiton



PAG. 236

DESIGN _ 40010
Válvula escuadra
Angle Valve / Robinet
d'equerre

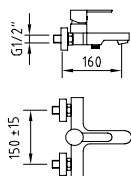

BAÑO-DUCHA

Bath-shower mixer | Mitigeur bain-douche

Mezclador baño-ducha, aireador, inversor integrado
 Bath-shower mixer, aerator, hidden diverter.
 Mitigeur bain-douche, aérateur, inverseur intégré

Incluye teléfono ducha, flexo y soporte
 Includes handset, hose and holder
 Inclus douche, flexible et support
 (90796, 97670, 96458)

Ref.	€	
ec1 98105	173,00	8

Sin kit ducha
 Without shower kit
 Sans kit de douche

Ref.	€	
ACS ec1 98541	153,00	8



- 98240
- 98238
- 96200
- 97817

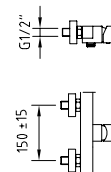

DUCHA

Shower mixer | Mitigeur Douche

Mezclador para ducha.
 Shower mixer.
 Mitigeur douche

Incluye teléfono ducha, flexo y soporte
 Includes handset, hose and holder
 Inclus douche, flexible et support
 (90796, 97670, 96458)

Ref.	€	
ec1 98106	143,00	8

Sin kit ducha
 Without shower kit
 Sans kit de douche

Ref.	€	
ACS ec1 98542	123,00	8

- 98240
- 98238

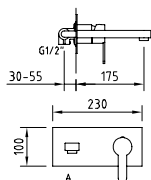

LAVABO EMPOTRAR

Concealed basin | Mitigeur lavabo à encastrer

Mezclador empotrable, caño mural con aireador, longitud 175mm.
 Concealed basin, areator, wall spout length 175mm.
 Mitigeur lavabo encastré, aérateur, bec 175 mm.

Ref.	€	
ec1 98470	186,00	12

- 98240
- 90761
- 90025

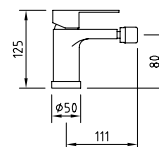

BIDÉ

Bidet mixer | Mitigeur bidet

Mezclador con aireador a rótula y flexibles M-10 3/8" x 420 mm.
 Mixer, swivel aerator, flexible hoses M-10 3/8" x 420 mm.
 Mitigeur bidet, aérateur rotule, raccords flexibles M-10 3/8" x 420 mm

Ref.	€	
ACS ec1 98104	127,00	12

- 98240
- 98238
- 90026



PAG. 129

Iclever 2 _ 98711+98717
 Ducha empotrada 1 vía
 Concealed bath-shower 1 outlet diverter
 Douche encastré 1 voie



PAG. 131

Iclever 2 _ 98711+98732
 Ducha empotrada 2 vías
 Concealed bath-shower 2 outlet diverter
 Douche encastré 2 voies



PAG. 181

ARTIC Urban_98107
 Fregadero
 Sink mixer
 Mitigeur évier



PAG. 140

STYLE 99627
 Conjunto ducha
 Shower kit
 Kit douche

Caiman *elegance*

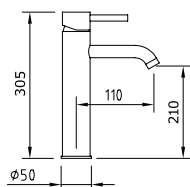

LAVABO 210

Tall basin mixer 210 | Mitigeur lavabo 210

Mezclador con aireador y flexibles M-10 3/8" x 600 mm.
Mixer, aerator, flexible hoses M-10 3/8" x 600 mm.
Mitigeur Lavabo bec haut, aérateur, raccords flexibles M-10 3/8" x 600 mm

	Ref.	€	
	ec1 97065	182,00	6

95132 96205 98600

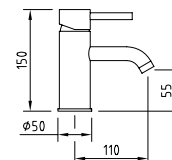

LAVABO 55

Basin mixer 55 | Mitigeur lavabo 55

Mezclador con aireador y flexibles M-10 3/8" x 370 mm.
Mixer, aerator, flexible hoses M-10 3/8" x 370 mm.
Mitigeur Lavabo, aérateur, raccords flexibles M-10 3/8" x 370 mm

	Ref.	€	
	ec1 97061	137,00	8

95132 96205 98600

Productos relacionados

Related products
Produits connexes



PAG. 126

iclever _ 98703 + 98707
Lavabo empotrado
Concealed basin mixer
Lavabo encastré



PAG. 237

VELA _ 97395 96255
Válvula desagüe metálico
Drain quick-clac metallic
Vidage métallique



PAG. 236

ELEGANCE _ 96174
Sifón botella latón
Brass bottle trap
Siphon laiton



PAG. 236

DESIGN _ 40010
Válvula escuadra
Angle Valve / Robinet
d'equerre

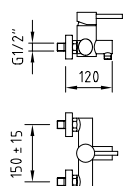

DUCHA
Shower mixer | Mitigeur Douche

Mezclador para ducha.
Shower mixer.
Mitigeur douche

Incluye teléfono ducha, flexo y soporte
Includes handset, hose and holder
Inclus douchette, flexible et support
(90796, 97114, 97113)

Ref.	€	📦
ec1 97064	205,00	6
ec1 97870	185,00	6

Sin kit ducha
Without shower kit
Sans kit de douche

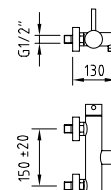
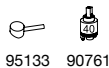

DUCHA
Shower mixer | Mitigeur Douche

Mezclador para ducha.
Shower mixer.
Mitigeur douche

Incluye teléfono ducha, flexo y soporte
Includes handset, hose and holder
Inclus douchette, flexible et support
(90796, 97114, 97113)

Ref.	€	📦
ec1 60162	215,00	6

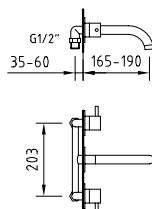

LAVABO EMPOTRADO MURAL
Concealed basin mixer | Mélangeur lavabo à encastrer

Mezclador empotrable de 1/2", caño mural con aireador, longitud 165-190 mm.
Concealed mixer 1/2" with aerator, wall spout length, 165-190 mm.
Mélangeur lavabo encastré, aérateur, bec 190 mm.

Ref.	€	📦
97076	210,00	8

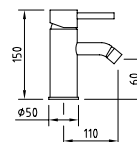
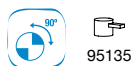

BIDÉ
Bidet mixer | Mitigeur bidet

Mezclador con aireador a rótula y flexibles M-10 3/8" x 370 mm.
Mixer, swivel aerator, flexible hoses M-10 3/8" x 370 mm.
Mitigeur bidet, aérateur rotule, raccords flexibles M-10 3/8" x 370 mm

Ref.	€	📦
ec1 97062	137,00	8



PAG. 114

elegance_99451
Accesorios de baño
Bathroom accessories
Accessoires de salle de bain



PAG. 129

Iclever 2_98711+98715
Ducha empotrada 1 vía
Concealed bath-shower 1 outlet diverter
Douche encastré 1 voie



PAG. 131

Iclever 2_98711+98730
Ducha empotrada 2 vías
Concealed bath-shower 2 outlet diverter
Douche encastré 2 voies



PAG. 182

CAIMAN elegance 60161
Fregadero
Sink mixer / Mitigeur évier



PAG. 140

STYLE_99627
Conjunto ducha
Shower kit
Kit douche

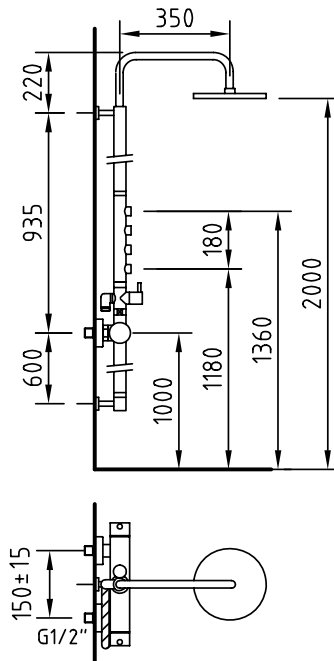

CONJUNTO DE DUCHA TERMOSTÁTICO 4 JETS
Thermostatic shower system 4 jets I
Colonne thermostatique douche hydromassage

Mezclador de ducha termostático, 4 rociadores frontales de hidromasaje, soporte articulado fijo.
 Adjustable thermostatic shower system with diverter built in and body jets.
 4 jets, support douchette fixe, inverseurs céramiques, pomme de douche, douchette et flexible.

Incluye
 Includes
 Inclus



Ref.	€	
96436	1075,00	4

NO EXTENSIBLE
 NOT EXTENDABLE.
 NON EXTENSIBLE



98027

Productos relacionados
 Related products
 Produits connexes



PAG. 148

SILVER HOSE _ 98880
 Flexible. Acabado en plata
 Flexible. Silver finish
 Flexible. Finition argent



PAG. 148

FLEXIBLE _ 97114
 Cromado
 Chrome plated
 Chromé



PAG. 145

TREND _ 99609
 Teléfono ducha
 Handset
 Douchette



PAG. 136

SLIM INOX AIR _ 99603
 Rociador ø 200mm
 Shower head
 Pomme de douche

+ Termostático
Thermostatic / Thermostatique

+ Con **4 jets**
de hidromasaje
*With 4 body jets / Avec 4 jets
de massage*

+ Aconsejamos mirar con detalle las medidas de los extensibles, a fin de colocar los jets en la altura correcta.

We advise to see carefully the extensible bars measures, in order to place jets in the correct height.

Nous recommandons de bien vérifier les dimensions des barres extensibles, afin de placer les jets à la bonne hauteur.

Caiman xtreme

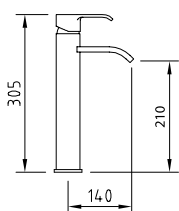

LAVABO 210

Basin mixer 210 | Mitigeur lavabo 210

Mezclador alto con rompeaguas y flexibles M-10 3/8" x 370 mm.
Tall mixer, water breaker, flexible hoses M-10 3/8" x 370 mm.
Mitigeur lavabo bec haut, brise-jet, raccords flexibles M-10 3/8" x 370 mm

	Ref.	€	
	ec1 98186	167,00	6



98212 98238

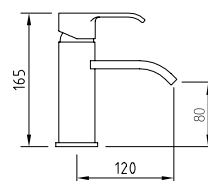

LAVABO 80

Basin mixer 80 | Mitigeur lavabo 80

Mezclador con rompeaguas y flexibles M-10 3/8" x 370 mm.
Basin mixer, water breaker, flexible hoses M-10 3/8" x 370 mm.
Mitigeur lavabo, brise-jet, raccords flexibles M-10 3/8" x 370 mm

	Ref.	€	
	ec1 98185	122,00	8



98212 98238

Productos relacionados

Related products
Produits connexes



PAG. 116

xtreme _ 98655
Accesorios de baño
Bathroom accessories
Accessoires de salle de bain



PAG. 237

VELA _ 97395 96255
Válvula desagüe metálico
Drain quick-clac metallic
Vidage métallique



PAG. 236

ELEGANCE _ 96174
Sifón botella latón
Brass bottle trap
Siphon laiton



PAG. 236

DESIGN _ 40010
Válvula escuadra
Angle Valve / Robinet
d'equerre

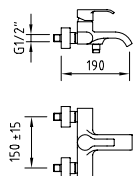

BAÑO-DUCHA
Bath-shower mixer | Mitigeur bain-douche

Mezclador baño-ducha, aireador, inversor integrado
Bath-shower mixer, aerator, hidden diverter.
Mitigeur bain-douche, aérateur, inverseur intégré

Incluye teléfono ducha, flexo y soporte
Includes handset, hose and holder
Inclus douchette, flexible et support
(90796, 97670, 96458)

	Ref.	€	📦
	ec1 98188	187,00	8
	ec1 98543	167,00	8

Sin kit ducha
Without shower kit
Sans kit de douche

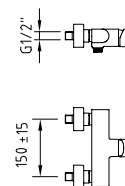
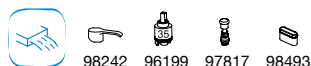

DUCHA
Shower mixer | Mitigeur Douche

Mezclador para ducha.
Shower mixer.
Mitigeur douche

Incluye teléfono ducha, flexo y soporte
Includes handset, hose and holder
Inclus douchette, flexible et support
(90796, 97670, 96458)

	Ref.	€	📦
	ec1 98189	157,00	6
	ec1 98544	137,00	6

Sin kit ducha
Without shower kit
Sans kit de douche

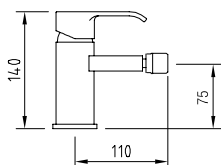
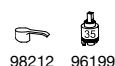

BIDÉ
Bidet mixer | Mitigeur bidet

Mezclador con aireador a rótula y flexibles M-10 3/8" x 370 mm.
Mixer, swivel aerator, flexible hoses M-10 3/8" x 370 mm.
Mitigeur bidet, aérateur rotule, raccords flexibles M-10 3/8" x 370 mm

	Ref.	€	📦
	ec1 98187	122,00	8

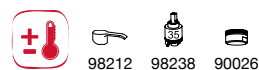

PAG. 140



PAG. 182



PAG. 129



PAG. 131

Iclever 2 _ 98711+98718
Ducha empotrada 1 via
Concealed bath-shower 1 outlet diverter
Douche encastré 1 voie

Iclever 2 _ 98711+98733
Ducha empotrada 2 vias
Concealed bath-shower 2 outlet diverter
Douche encastré 2 voies

STYLE_99627
Conjunto ducha
Shower kit
Kit douche

CAIMAN xtreme_98190
Fregadero
Sink mixer
Mitigeur évier

Caiman urban

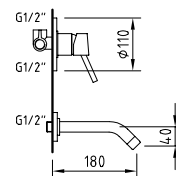
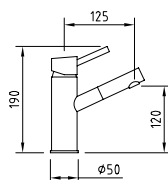

LAVABO 120

Basin mixer 120 | Mitigeur lavabo 120

Mezclador con aireador y flexibles M-10 3/8" x 370 mm.
Mixer, aerator, flexible hoses M-10 3/8" x 370 mm.
Mitigeur Lavabo, aérateur, raccords flexibles M-10 3/8" x 370 mm

	Ref.	€	
	93510	117,00	8



96223 97372 96202

LAVABO EMPOTRAR

Basin mixer | Mitigeur lavabo

Mezclador empotrable de 1/2", caño mural de 1/2", con aireador, longitud 180 mm.
Concealed mixer 1/2" with aerator, wall spout length 1/2", 180 mm.
Mitigeur lavabo encastré, aérateur, bec 180 mm.

	Ref.	€	
	96468	107,00	8



96223 97372 90026

Productos relacionados Related products Produits connexes



PAG. 118

urban _ 99459
Accesorios de baño
Bathroom accessories
Accessoires de salle de bain



PAG. 237

VELA _ 97395_96255
Válvula desagüe metálico
Drain quick-clac metallic
Vidage métallique



PAG. 236

ELEGANCE _ 96174
Sifón botella latón
Brass bottle trap
Siphon laiton



PAG. 140

STYLE _ 99627
Conjunto ducha
Shower kit
Kit douche



BAÑO-DUCHA
Bath-shower mixer | Mitigeur bain-douche

Mezclador baño-ducha, aireador, inversor automático
Bath-shower mixer, aerator, automatic diverter.
Mitigeur bain-douche, aérateur, inverseur automatique

	Ref.	€	📦
Incluye teléfono ducha, flexo y soporte Includes handset, hose and holder Inclus douchette, flexible et support (90796, 97670, 96458)	93512	257,00	6
Sin kit ducha Without shower kit Sans kit de douche	97899	237,00	6



DUCHA
Shower mixer | Mitigeur Douche

Mezclador para ducha.
Shower mixer.
Mitigeur douche

	Ref.	€	📦
Incluye teléfono ducha, flexo y soporte Includes handset, hose and holder Inclus douchette, flexible et support (90796, 97670, 96458)	93513	207,00	8
Sin kit ducha Without shower kit Sans kit de douche	97900	187,00	8

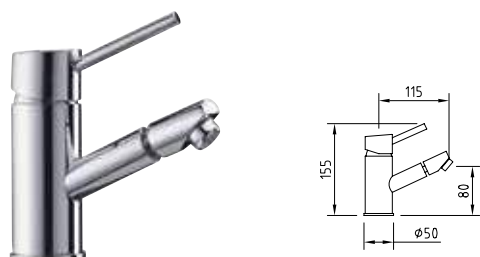
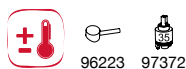

BIDÉ
Bidet mixer | Mitigeur bidet

Mezclador con aireador a rótula y flexibles M-10 3/8" x 370 mm.
Mixer, swivel aerator, flexible hoses M-10 3/8" x 370 mm.
Mitigeur bidet, aérateur rotule, raccords flexibles M-10 3/8" x 370 mm

	Ref.	€	📦
	93511	117,00	8

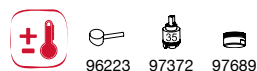

BAÑO-DUCHA TERMOSTÁTICO
Thermostatic bath-shower mixer
Mitigeur bain-douche thermostatique

Mezclador termostático, aireador, inversor automático para baño-ducha.
Thermostatic bath-shower mixer, aerator, automatic diverter.
Mitigeur bain-douche thermostatique, aérateur, inverseur automatique

	Ref.	€	📦
Incluye teléfono ducha, flexo y soporte Includes handset, hose and holder Inclus douchette, flexible et support (90796, 97670, 96458)	96749	317,00	4
Sin kit ducha Without shower kit Sans kit de douche	98160	297,00	4



DESIGN _ 40010
Válvula escuadra
Angle Valve / Robinet
d'équerre



Iclever 2 _ 98711+98719
Ducha empotrada 1 via
Concealed bath-shower 1 outlet diverter
Douche encastré 1 voie



Iclever 2 _ 98711+98734
Ducha empotrada 2 vias
Concealed bath-shower 2 outlet diverter
Douche encastré 2 voies



CAIMAN urban_92603
Fregadero
Sink mixer
Mitigeur évier

With2 antigua

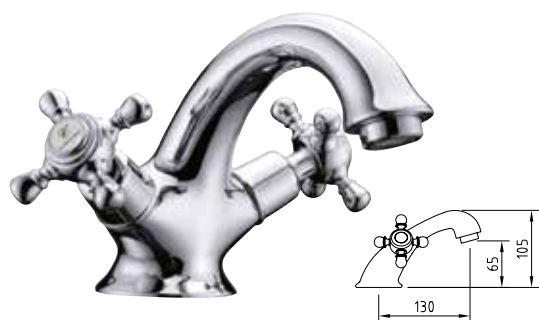

LAVABO 65

Basin mixer 65 | Mélangeur lavabo 65

Mezclador con aireador y flexibles M-10 3/8" x 370 mm.
Mixer, aerator, flexible hoses M-10 3/8" x 370 mm.
Mélangeur lavabo, aérateur, raccords flexibles M-10 3/8" x 370 mm

Ref.	€	📦
94474	70,00	12

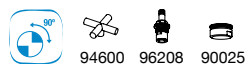

LAVABO REPISA

Three hole deck basin | Mélangeur lavabo 3 trous

Grifería mezcladora de repisa con aireador, caño alto. Flexible 300 mm
Three-hole basin mixer with aerator. Flexible hoses 300 mm
Mélangeur lavabo 3 trous, aérateur. Flexible 300 mm

Ref.	€	📦
98426	178,00	8

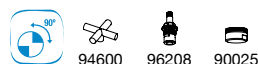

Productos relacionados

Related products
Produits connexes



URBAN _ 98650
Accesorios de baño
Bathroom accessories
Accessoires de salle de bain

PAG. 120



LEO _ 98674
Válvula desagüe Universal
Universal drain quick-clac
Vidage Universel

PAG. 237



URBAN _ 90755
Sifón botella latón
Universal drain quick-clac
Siphon laiton

PAG. 236



STYLE 99627
Conjunto ducha
Shower kit
Kit douche

PAG. 140

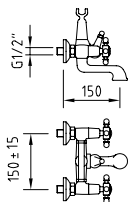

BAÑO-DUCHA
Bath-shower mixer | Mitigeur bain-douche

Mezclador baño-ducha, inversor
Bath-shower mixer, diverter.
Mélangeur bain-douche, inverseur

	Ref.	€	📦
Incluye teléfono ducha, flexo Includes handset, hose Inclus douche, flexible (90758, 97670)	94476	122,00	8
Sin kit ducha Without shower kit Sans kit de douche	97929	102,00	8

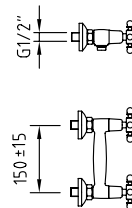
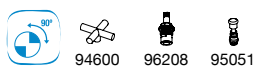

DUCHA
Shower mixer | Mitigeur Douche

Mezclador para ducha.
Shower mixer.
Mitigeur douche

	Ref.	€	📦
Incluye teléfono ducha, flexo Includes handset, hose Inclus douche, flexible (90758, 97670, 96159)	94477	78,00	12
Sin kit ducha Without shower kit Sans kit de douche	97930	58,00	12

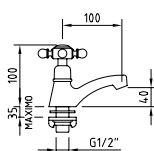

GRIFO SIMPLE REPISA 40
Single washbain tap 40 | Robinet simple 40

Grifo de repisa con aireador.
Deck mounted single basin tap, with aerator.
Robinet lavabo, aérateur, 1/2"

	Ref.	€	📦
	94489	26,00	24

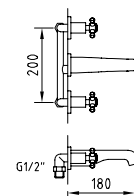
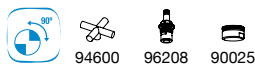

LAVABO EMPOTRADO MURAL
Concealed basin mixer | Mélangeur lavabo mural 3 trous

Mezclador empotrable de 1/2", caño mural con aireador, longitud 180 mm.
Concealed mixer 1/2" with aerator, wall spout length 180 mm.
Mélangeur lavabo encastré, aérateur, bec 180 mm.

	Ref.	€	📦
	98429	146,00	8

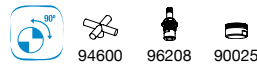

DESIGN _ 40010
Válvula escuadra
Angle Valve
Robinet d'equerre



ANTIGONA _ 90758
Teléfono ducha
Handset
Douchette



NEW TAMPA _ 96437
Rociador
Shower head
Pomme de douche



WITH2 Antigona_92049
Fregadero
Sink mixer / Mitigeur évier

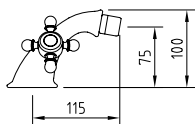

BIDÉ

Bidet mixer | Mélangeur bidet

Mezclador con aireador a rótula y flexibles M-10 3/8" x 370 mm.
 Mixer, swivel aerator, flexible hoses M-10 3/8" x 370 mm.
 Mélangeur bidet, aérateur rotule, raccords flexibles M-10 3/8" x 370 mm

Ref.	€	📦
ACS 94475	70,00	12

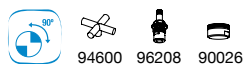

94600 96208 90026



Teléfono ducha
 Handset
 90758 Douchette

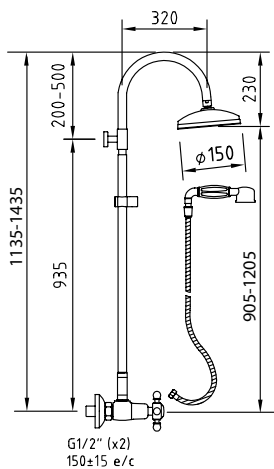

CONJUNTO DE DUCHA TERMOSTÁTICO EXTENSIBLE

**Extensible Thermostatic shower system
 Colonne thermostatique douche extensible**

Mezclador de ducha termostático con tubo extensible Cross (96118).
 Adjustable Thermostatic bath-shower system Cross (96118) with diverter and fixed handset.
 Support douchette orientable, inverseur automatique, pomme de douche, douchette et flexible

Incluye
 Includes
 Inclus



Ref.	€	📦
96746	557,00	3



94600 98027

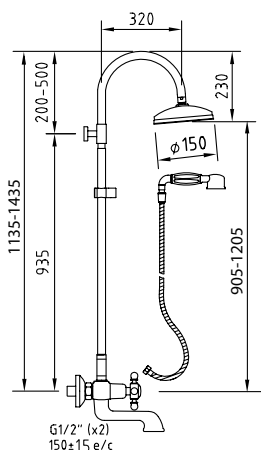

Inversor incorporado en la maneta de caudal
Integral diverter in the flow handle
Inverseur intégré dans la poignée

CONJUNTO DE BAÑO-DUCHA EXTENSIBLE
Extendible bath-shower system
Colonne mélangeur bain-douche extensible

Mezclador de baño-ducha con tubo extensible Cross (96118).
Adjustable bath-shower system Cross (96118) with diverter and fixed handset.
Support douchette orientable, inverseur manuel/automatique, pomme de douche, douchette et flexible

Incluye
Includes
Inclus



New Tampa
96437



Antigona
90758



1,75 m
97670



Antigona
96159



Support
98497



Antao
96120

Ref.	€	📦
96747	483,00	3



94600



96208



95051

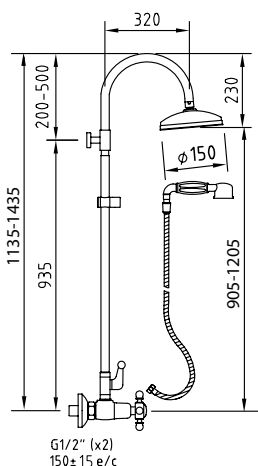
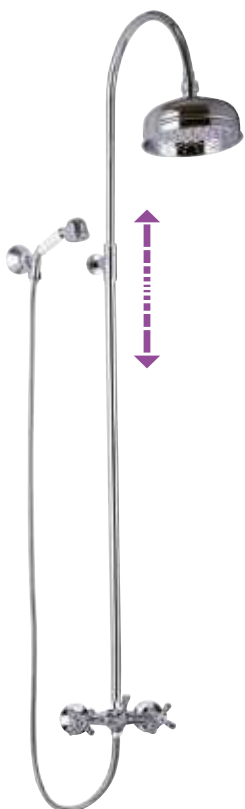

CONJUNTO DE DUCHA EXTENSIBLE
Extendible shower system | *Colonne mélangeur*
douche extensible

Mezclador de ducha con tubo extensible Cross (96118).
Adjustable shower system Cross (96118) with diverter and fixed handset.
Support douchette orientable, inverseur manuel, pomme de douche, douchette et flexible

Incluye
Includes
Inclus



New Tampa
96437



Antigona
90758



1,75 m
97670



Antigona
96159



Support
98497

Ref.	€	📦
96154	440,00	3



94600



96208



95051

Productos relacionados
Related products
Produits connexes



PAG. 148

SILVER HOSE _ 98880
Flexible. Acabado en plata
Flexible. Silver finish
Flexible. Finition argent



PAG. 148

FLEXIBLE _ 97114
Cromado
Chrome plated
Chromé



PAG. 136

ROUND AIR _ 99604
Rociador ø 120mm
Shower head
Pomme de douche



LAVABO 175
Basin mixer 175 | Mélangeur lavabo 175

Mezclador alto con aireador y flexibles M-10 3/8" x 370 mm.
Tall mixer with aerator, flexible hoses M-10 3/8" x 370 mm.
Mélangeur lavabo, aérateur, raccords flexibles M-10 3/8" x 370 mm

	Ref.	€	📦
	97001	147,00	8



95126



LAVABO REPISA 180
Three hole deck basin | Mélangeur lavabo 3 trous

Grifería mezcladora de repisa con aireador, caño alto 180mm.
Three-hole basin mixer with aerator spout 180mm.
Mélangeur lavabo 3 trous, aérateur

	Ref.	€	📦
	97006	224,00	6



95126



Productos relacionados
Related products
Produits connexes



PAG. 120

Urban _ 98650
Accesorios de baño
Bathroom accessories
Accessoires de salle de bain



PAG. 237

VELA _ 97395 96255
Válvula desagüe metálico
Drain quick-clac metallic
Vidage métallique



PAG. 236

ELEGANCE _ 96174
Sifón botella latón
Brass bottle trap
Siphon laiton



PAG. 140

STYLE 99627
Conjunto ducha
Shower kit
Kit douche



BAÑO-DUCHA
Bath-shower mixer | Mitigeur bain-douche

Mezclador baño-ducha, aireador, inversor automático
Bath-shower mixer, aerator, automatic diverter.
Mélangeur bain-douche, aérateur, inverseur

Incluye teléfono ducha, flexo y soporte
Includes handset, hose and holder
Inclus douchette, flexible et support
(90796, 97114, 97113)

Sin kit ducha
Without shower kit
Sans kit de douche

Ref.	€	📦
97003	235,00	6
97883	215,00	6



95126 96939



DUCHA
Shower mixer | Mitigeur Douche

Mezclador para ducha.
Shower mixer.
Mitigeur douche

Incluye teléfono ducha, flexo y soporte
Includes handset, hose and holder
Inclus douchette, flexible et support
(90796, 97114, 97113)

Sin kit ducha
Without shower kit
Sans kit de douche

Ref.	€	📦
97004	215,00	6
97884	195,00	6



95126



LAVABO EMPOTRAR
Concealed basin mixer
Mélangeur lavabo à encastrer

Mezclador empotrable, caño mural con aireador.
Concealed basin mixer, spout with aerator.
Mélangeur lavabo encastré, aérateur, bec 190 mm.

Ref.	€	📦
97007	224,00	6

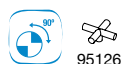

95126



BIDÉ
Bidet mixer | Mélangeur bidet

Mezclador con aireador a rótula y flexibles M-10 3/8" x 370 mm.
Mixer, swivel aerator, flexible hoses M-10 3/8" x 370 mm.
Mélangeur bidet, aérateur rotule, raccords flexibles M-10 3/8" x 370 mm

Ref.	€	📦
97002	147,00	8

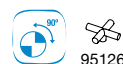

95126



PAG. 236

DESIGN_40010
Válvula escuadra
Angle Valve
Robinet d'equerre



PAG. 139

BEAM_60303
Rociador
Shower head
Pomme de douche



PAG. 143

BEAM_60304
Teléfono de ducha
Handset
Douchette



PAG. 185

WITH2 morea_97005
Fregadero
Sink mixer
Mitigeur évier

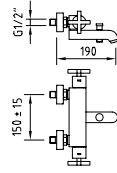

BAÑO-DUCHA TERMOSTÁTICO | Thermostatic bath-shower mixer | Mitigeur bain-douche thermostatique

Mezclador baño-ducha, aireador, inversor automático
Bath-shower mixer, aerator, automatic diverter.
Mitigeur bain-douche thermostatique, aérateur, inverseur automatique

Incluye teléfono ducha, flexo y soporte
Includes handset, hose and holder
Inclus douchette, flexible et support
(90796, 97114, 97113)

Sin kit ducha
Without shower kit
Sans kit de douche

Ref.	€	📦
97012	407,00	8
98158	387,00	8



95126 96939 98027

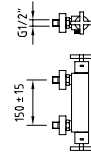

DUCHA TERMOSTÁTICA | Thermostatic shower mixer | Mitigeur douche thermostatique

Mezclador para ducha.
Shower mixer.
Mitigeur douche thermostatique
Mélangeur bain-douche, aérateur, inverseur

Incluye teléfono ducha, flexo y soporte
Includes handset, hose and holder
Inclus douchette, flexible et support
(90796, 97114, 97113)

Sin kit ducha
Without shower kit
Sans kit de douche

Ref.	€	📦
97013	348,00	8
98159	328,00	8



95126 98027

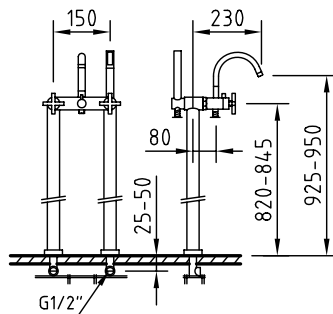

BAÑO-DUCHA FIJACIÓN SUELO

Floor standing bath-shower mixer | Mélangeur bain-douche sur colonnes avec prise d'eau au sol

Baño ducha fijación suelo, aireador, inversor.
Floor standing bath-shower mixer, aerator, diverter.
Mélangeur bain-douche sur colonne avec prise d'eau au sol, aérateur, inverseur automatique

Incluye teléfono ducha y flexo
Includes handset and hose
Inclus douchette et flexible
(90796, 97114)

Ref.	€	📦
97020	678,00	6



95126

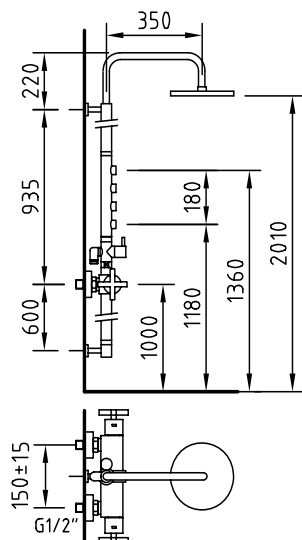

CONJUNTO DE DUCHA TERMOSTÁTICO 4 JETS
Thermostatic shower system 4 jets | Colonne thermostatique
douche hydromassage

Mezclador de ducha termostático, 4 rociadores frontales de hidromasaje, soporte articulado fijo.
 Adjustable thermostatic shower system with diverter built in and body jets.
 4 jets, support douchette fixe, inverseurs céramiques, pomme de douche, douchette et flexible

Incluye
 Includes
 Inclus



Ø200
 97109



Caiman
 90796



1,80 m
 97114

Ref.	€	
97018	1.075,00	4

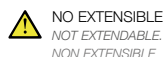

Elegantes manetas

dan un aire vanguardista y original al baño y cocina.

Elegant handles give an avant-garde and original air to the bathroom and kitchen.

Des poignées élégantes qui donnent un air original à la salle de bain et à la cuisine.

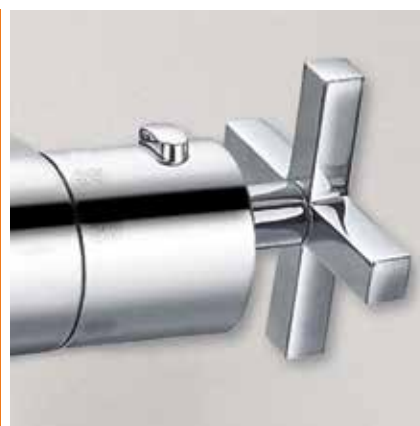

Con 4 jets de hidromasaje,

sensación de spa en casa.

With 4 body jets, spa feeling at home.

Avec 4 jets d'hydromassage, un effet spa à la maison.



Termostático

Déjate envolver en la ducha con la temperatura perfecta que tu elijas.

Thermostatic. Let yourself be wrapped in the shower with the perfect temperature that you choose.

Thermostatique. Détendez-vous et profitez d'une douche à la température toujours idéale.



STYLES PRO



Bahama **xtreme**
74



Habana **xtreme**
76



Start *elegance*
78



Start **xtreme**
82



Start **urban**
86



S12 *elegance*
96



S12 **xtreme**
98



S12 **urban**
100



Be versatile, keep it simple

Our basics



Panam *elegance*

88



Panam **xtreme**

90



Panam **urban**

92



With2 **guayama**

102



Nine **urban**

104



Bahama xtreme

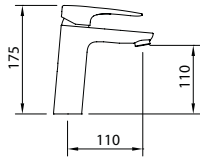

LAVABO 110

Basin mixer 110 | Mitigeur lavabo 110

Mezclador con aireador y flexibles M-10 3/8" x 500 mm.
Mixer, aerator, flexible hoses M-10 3/8" x 500 mm.
Mitigeur lavabo, aérateur, raccords flexibles M-10 3/8" x 500 mm

	Ref.	€	
	99185	92,00	12
	99186	94,00	12
	99187	96,00	12

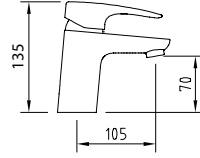
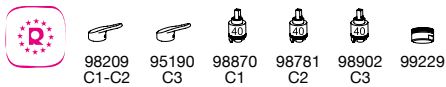

LAVABO 70

Basin mixer 70 | Mitigeur lavabo 70

Mezclador con aireador y flexibles M-10 3/8" x 420 mm.
Mixer, aerator, flexible hoses M-10 3/8" x 420 mm.
Mitigeur lavabo, aérateur, raccords flexibles M-10 3/8" x 420 mm

	Ref.	€	
	99145	80,00	12
	98910	82,00	12
	98175	84,00	12

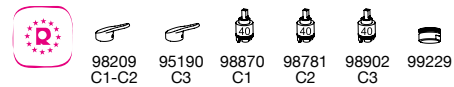

Productos relacionados

Related products
Produits connexes



PAG. 118

urban _ 99459
Accesorios de baño
Bathroom accessories
Accessoires de salle de bain



PAG. 237

LEO _ 98674
Válvula desagüe Universal
Universal drain quick-clac
Vidage Universel



PAG. 236

ELEGANCE _ 96174
Sifón botella latón
Brass bottle trap
Siphon laiton



PAG. 237

METÁLICO _ 99127
Desagüe automático
Pop-up
Vidage automatique

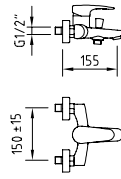

BAÑO-DUCHA
Bath-shower mixer | Mitigeur bain-douche

Mezclador con aireador baño-ducha, inversor automático.
Bath-shower mixer with aerator, automatic diverter.
Mitigeur bain-douche, aérateur, inverseur automatique.

Incluye teléfono ducha, flexo y soporte
Includes handset, hose and holder
Inclus douchette, flexible et support
(96108, 97670, 98208)

	ec1	98177	145,00	8	
		C1	98282	130,00	8

Sin kit ducha
Without shower kit
Sans kit de douche

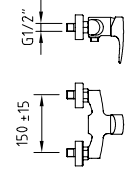
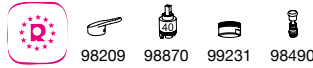

DUCHA
Shower mixer | Mitigeur douche

Mezclador para ducha.
Shower mixer.
Mitigeur douche

Incluye teléfono ducha, flexo y soporte
Includes handset, hose and holder
Inclus douchette, flexible et support
(96108, 97670, 98208)

	ec1	98178	115,00	8	
		C1	98283	100,00	8

Sin kit ducha
Without shower kit
Sans kit de douche

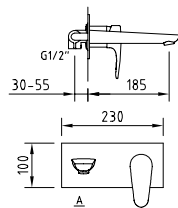

LAVABO EMPOTRAR
Concealed basin | Mitigeur lavabo à encastrer

Mezclador empotrable, caño mural con aireador, longitud 185 mm.
Concealed basin, aerator, wall mounted spout length 185 mm.
Mitigeur lavabo encastré, aérateur, bec 185 mm.

Ref.	€	
ec1 98423	176,00	6

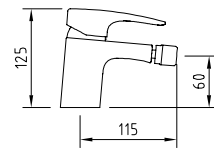

BIDÉ
Bidet mixer | Mitigeur bidet

Mezclador con aireador a rótula, flexibles M-10 3/8" x 370 mm.
Mixer, swivel aerator, flexible hoses M-10 3/8" x 370 mm.
Mitigeur bidet, aérateur rotule, raccords flexibles M-10 3/8" x 370 mm

Ref.	€		
C2	98176	83,00	12

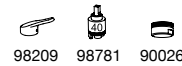

PAG. 129

Iclever 2 _ 98711+98723
Ducha empotrada 1 vía
Concealed bath-shower 1 outlet diverter
Douche encastré 1 voie



PAG. 131

Iclever 2 _ 98711+98738
Ducha empotrada 2 vías
Concealed bath-shower 2 outlet diverter
Douche encastré 2 voies



PAG. 140

CITY AIR _ 99624
Conjunto ducha
Shower kit
Kit douche



PAG. 186

BAHAMA Xtreme_98913
Fregadero
Sink mixer
Mitigeur évier

Habana xtreme

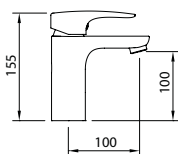

LAVABO 100

Tall basin mixer 100 | Mitigeur lavabo 100

Mezclador con aireador y flexibles M-10 3/8" x 500 mm.
Mixer, aerator, flexible hoses M-10 3/8" x 500 mm.
Mitigeur lavabo, aérateur, raccords flexibles M-10 3/8" x 500 mm

		Ref.	€	📦
	ec1	99195	86,00	12
	ec2	99196	89,00	12
	ec3	99197	91,00	12

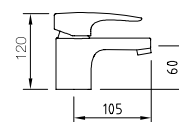
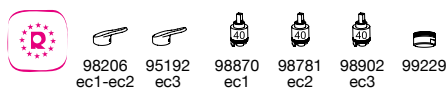

LAVABO 60

Basin mixer 60 | Mitigeur lavabo 60

Mezclador con aireador y flexibles M-10 3/8" x 420 mm.
Mixer, aerator, flexible hoses M-10 3/8" x 420 mm.
Mitigeur lavabo, aérateur, raccords flexibles M-10 3/8" x 420 mm

		Ref.	€	📦
	ec1	99149	78,00	12
	ec2	98914	80,00	12
	ec3	98165	82,00	12

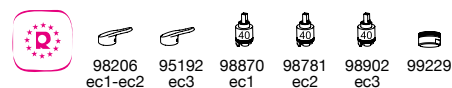

Productos relacionados

Related products
Produits connexes



PAG. 116

xtreme _ 98655
Accesorios de baño
Bathroom accessories
Accessoires de salle de bain



PAG. 237

HYDRA _ 98675
Válvula desagüe Universal
Universal drain quick-clac
Vidage Universel



PAG. 236

XTREME _ 96173
Sifón botella latón
Brass bottle trap
Siphon laiton



PAG. 237

METÁLICO _ 99127
Desagüe automático
Pop-up
Vidage automatique

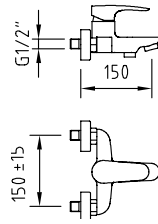

BAÑO-DUCHA
Bath-shower mixer | Mitigeur bain-douche

Mezclador baño-ducha, aireador, inversor automático
Bath-shower mixer, aerator, automatic diverter.
Mitigeur bain-douche, aérateur, inverseur automatique

Incluye teléfono ducha, flexo y soporte
Includes handset, hose and holder
Inclus douche, flexible et support
(96108, 97670, 98208)

	ec1	98167	113,00	8
--	-----	-------	--------	---

Sin kit ducha
Without shower kit
Sans kit de douche

	ec1	98280	98,00	8
--	-----	-------	-------	---

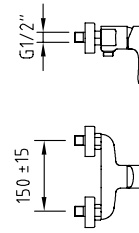
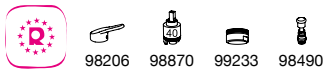

DUCHA
Shower mixer | Mitigeur douche

Mezclador para ducha.
Shower mixer.
Mitigeur douche

Incluye teléfono ducha, flexo y soporte
Includes handset, hose and holder
Inclus douche, flexible et support
(96108, 97670, 98208)

	ec1	98168	91,00	8
--	-----	-------	-------	---

Sin kit ducha
Without shower kit
Sans kit de douche

	ec1	98281	76,00	8
--	-----	-------	-------	---

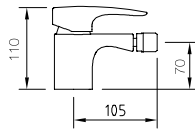
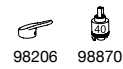

BIDÉ
Bidet mixer | Mitigeur bidet

Mezclador con aireador a rótula y flexibles M-10 3/8" x 370 mm.
Mixer, swivel aerator, flexible hoses M-10 3/8" x 370 mm.
Mitigeur bidet, aérateur rotule, raccords flexibles M-10 3/8" x 370 mm

Ref.	€	📦
ec2 98166	80,00	12



SISTEMA COLD OPEN DE APERTURA EN FRÍO. AHORRA EN AGUA CALIENTE.

Cold Open system. It opens in cold position. You save energy.
Cold Open. Système d'ouverture en eau froide pour faire des économies d'énergie.



PAG. 193

HABANA xtreme_98549
Fregadero mural
Wall mounted sink mixer
Mitigeur évier murale



PAG. 186

HABANA xtreme_98917
Fregadero
Wall mounted sink mixer
Mitigeur évier



PAG. 193

HABANA xtreme_98552
Fregadero extraíble
Pull-out sink mixer
Mitigeur évier extractible

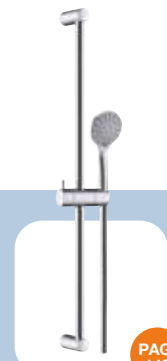

PAG. 140

CITY AIR_99624
Conjunto ducha
Shower kit
Kit douche



Start elegance



LAVABO 100

Tall basin mixer 100 | Mitigeur lavabo 100

Mezclador con aireador y flexibles M-10 3/8" x 500 mm.
Mixer, aerator, flexible hoses M-10 3/8" x 500 mm.
Mitigeur lavabo, aérateur, raccords flexibles M-10 3/8" x 500 mm



	Ref.	€	📦
  ec1	60173	77,00	8



LAVABO 65

Basin mixer 65 | Mitigeur lavabo 65

Mezclador con aireador y flexibles M-10 3/8" x 420 mm.
Mixer, aerator, flexible hoses M-10 3/8" x 420 mm.
Mitigeur lavabo, aérateur, raccords flexibles M-10 3/8" x 420 mm

	Ref.	€	📦
  ec1	60170	67,00	12



Productos relacionados

Related products
Produits connexes



PAG. 247

PEANA _ 60559
Base plástica
Plastic base
Base en plastique



PAG. 237

LEO _ 98674
Válvula desague Universal
Universal drain quick-clac
Vidage Universel



PAG. 236

ELEGANCE _ 96174
Sifón botella latón
Brass bottle trap
Siphon laiton

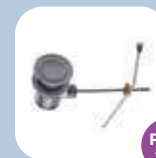

PAG. 237

METÁLICO _ 99127
Desague automático
Pop-up
Vidage automatique

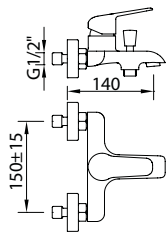

BAÑO-DUCHA
Bath-shower mixer | Mitigeur bain-douche

Mezclador baño-ducha, aireador, inversor automático
Bath-shower mixer, aerator, automatic diverter.
Mitigeur bain-douche, aérateur, inverseur automatique

	Ref.	€	📦
Incluye teléfono ducha, flexo y soporte Includes handset, hose and holder Inclus douchette, flexible et support (98342, 97670, 98208)	60179	116,00	8
Sin kit ducha Without shower kit Sans kit de douche	60180	101,00	8

- 95234
- 99817
- 96200
- 98490

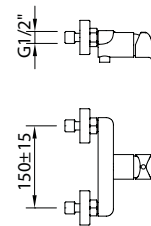

DUCHA
Shower mixer | Mitigeur Douche

Mezclador para ducha.
Shower mixer.
Mitigeur douche

	Ref.	€	📦
Incluye teléfono ducha, flexo y soporte Includes handset, hose and holder Inclus douchette, flexible et support (98342, 97670, 98208)	60181	95,00	8
Sin kit ducha Without shower kit Sans kit de douche	60182	80,00	8

- 95234
- 99817

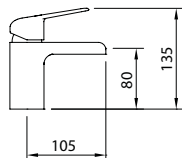

LAVABO CASCADA 80
Basin mixer 80 | Mitigeur lavabo 80

Mezclador, rompeaguas y flexibles M-10 3/8" x 420 mm.
Mixer, open spout, flexible hoses M-10 3/8" x 420 mm.
Mitigeur lavabo, brise-jet, raccords flexibles M-10 3/8" x 420 mm

	Ref.	€	📦
	99931	131,00	8

- 95234
- 97372

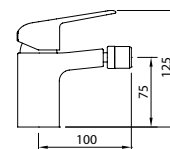

BIDÉ
Bidet mixer | Mitigeur bidet

Mezclador con aireador a rótula y flexibles M-10 3/8" x 420 mm.
Mixer, swivel aerator, flexible hoses M-10 3/8" x 420 mm.
Mitigeur bidet, aérateur rotule, raccords flexibles M-10 3/8" x 420 mm

	Ref.	€	📦
	60176	67,00	12

- 95234
- 99817
- 99232



PAG. 114

elegance _ 99451
Accesorios de baño
Bathroom accessories
Accessoires de salle de bain

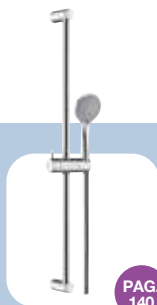

PAG. 140

CITY AIR _ 99624
Conjunto ducha
Shower kit
Kit douche



PAG. 192

START elegance _ 99386
Fregadero horizontal
Sink mixer
Mitigeur évier



PAG. 187

START elegance _ 60184
Fregadero
Sink mixer
Mitigeur évier

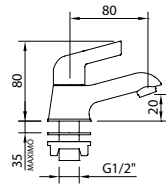

GRIFO SIMPLE REPISA 20
Single handle washbasin tap 20 | Robinet simple 20

Grifo de repisa con aireador.
Deck mounted single basin tap, with aerator.
Robinet lavabo, aérateur, 1/2"

	Ref.	€	☐
	99392	33,00	12

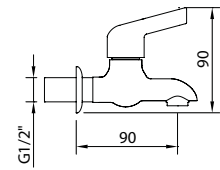

GRIFO SIMPLE MURAL
Single handle washbasin wall tap | Robinet simple mural

Grifo mural con aireador..
Wall single basin tap, with aerator.
Robinet lavabo mural, 1/2"

	Ref.	€	☐
	99393	26,00	12

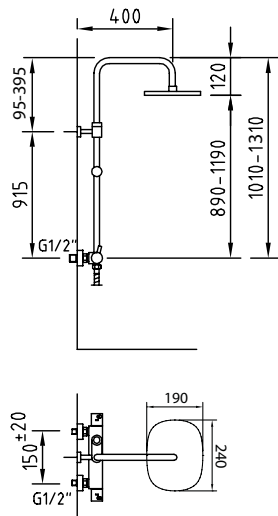

CONJUNTO DUCHA EXTENSIBLE
Extensible shower system
Colonne mitigeur bain-douche extensible

Mezclador de ducha con tubo extensible, soporte articulado.
Adjustable shower system with diverter built in.
Support douchette coulissant, inverseur intégré, pomme de douche, douchette et flexible

Incluye
Includes
Inclus



	Ref.	€	☐
	99646	360,00	-

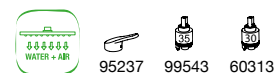

Inversor incorporado en la maneta de caudal
Integral diverter in the flow handle
Inverseur intégré dans la poignée

Productos relacionados
Related products
Produits connexes



PAG. 148

SILVER HOSE _ 98880
Flexible. Acabado en plata
Flexible. Silver finish
Flexible. Finition argent



PAG. 148

FLEXIBLE _ 97114
Cromado
Chrome plated
Chromé



PAG. 143

STYLE _ 99610
Teléfono ducha
Handset
Douchette



PAG. 139

AUTOCLEAN _ 60305
Rociador ø 230mm
Shower head
Pomme de douche



Start xtreme

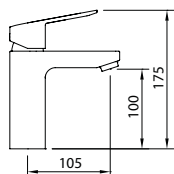

LAVABO 100

Tall basin mixer 100 | Mitigeur lavabo 100

Mezclador con aireador y flexibles M-10 3/8" x 500 mm.
Mixer, aerator, flexible hoses M-10 3/8" x 500 mm.
Mitigeur lavabo, aérateur, raccords flexibles M-10 3/8" x 500 mm

	Ref.	€	
ec1	60188	77,00	8



95226



99817



99229

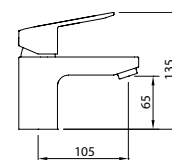

LAVABO 65

Basin mixer 65 | Mitigeur lavabo 65

Mezclador con aireador y flexibles M-10 3/8" x 420 mm.
Mixer, aerator, flexible hoses M-10 3/8" x 420 mm.
Mitigeur Lavabo, aérateur, raccords flexibles M-10 3/8" x 420 mm

	Ref.	€	
ec1	60185	67,00	12



95226



99817



99229

Productos relacionados Related products Produits connexes



PAG. 247

PEANA _ 60559
Base plástica
Plastic base
Base en plastique



PAG. 237

HYDRA _ 98675
Válvula desagüe Universal
Universal drain quick-clac
Vidage Universel



PAG. 236

XTREME _ 96173
Sifón botella latón
Brass bottle trap
Siphon laiton

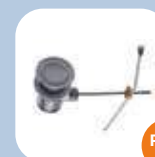

PAG. 237

MÉTÁLICO _ 99127
Desagüe automático
Pop-up
Vidage automatique

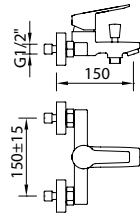

BAÑO-DUCHA
Bath-shower mixer | Mitigeur bain-douche

Mezclador baño-ducha, aireador, inversor automático
Bath-shower mixer, aerator, automatic diverter.
Mitigeur bain-douche, aérateur, inverseur automatique

	Ref.	€	📦
Incluye teléfono ducha, flexo y soporte Includes handset, hose and holder Inclus douche, flexible et support (98342, 97670, 98208)	ACS ec1 60194	116,00	8
Sin kit ducha Without shower kit Sans kit de douche	ACS ec1 60195	101,00	8

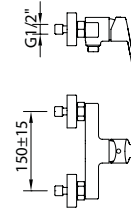
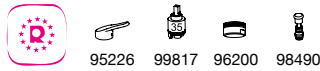

DUCHA
Shower mixer | Mitigeur Douche

Mezclador para ducha.
Shower mixer.
Mitigeur douche

	Ref.	€	📦
Incluye teléfono ducha, flexo y soporte Includes handset, hose and holder Inclus douche, flexible et support (98342, 97670, 98208)	ACS ec1 60196	95,00	8
Sin kit ducha Without shower kit Sans kit de douche	ACS ec1 60197	80,00	8

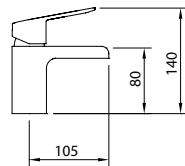

LAVABO CASCADA 80
Basin mixer 80 | Mitigeur lavabo 80

Mezclador, rompeaguas y flexibles M-10 3/8" x 420 mm.
Mixer, open spout, flexible hoses M-10 3/8" x 420 mm.
Mitigeur lavabo, brise-jet, raccords flexibles M-10 3/8" x 420 mm

	Ref.	€	📦
ACS ec2	99928	131,00	8

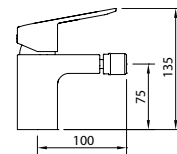

BIDÉ
Bidet mixer | Mitigeur bidet

Mezclador con aireador a rótula y flexibles M-10 3/8" x 420 mm.
Mixer, swivel aerator, flexible hoses M-10 3/8" x 420 mm.
Mitigeur bidet, aérateur rotule, raccords flexibles M-10 3/8" x 420 mm

	Ref.	€	📦
ACS ec1	60191	67,00	12



PAG. 116

xtreme_98655
Accesorios de baño
Bathroom accessories
Accessoires de salle de bain



PAG. 140

TREND_99626
Conjunto barra ducha
Sliding bar set
Ensemble barre douche



PAG. 45

NINE xtreme_60133
Ducha termostática
Thermostatic shower mixer
Mitigeur douche thermostatique



PAG. 187

START xtreme_60198
Fregadero
Sink mixer
Mitigeur évier

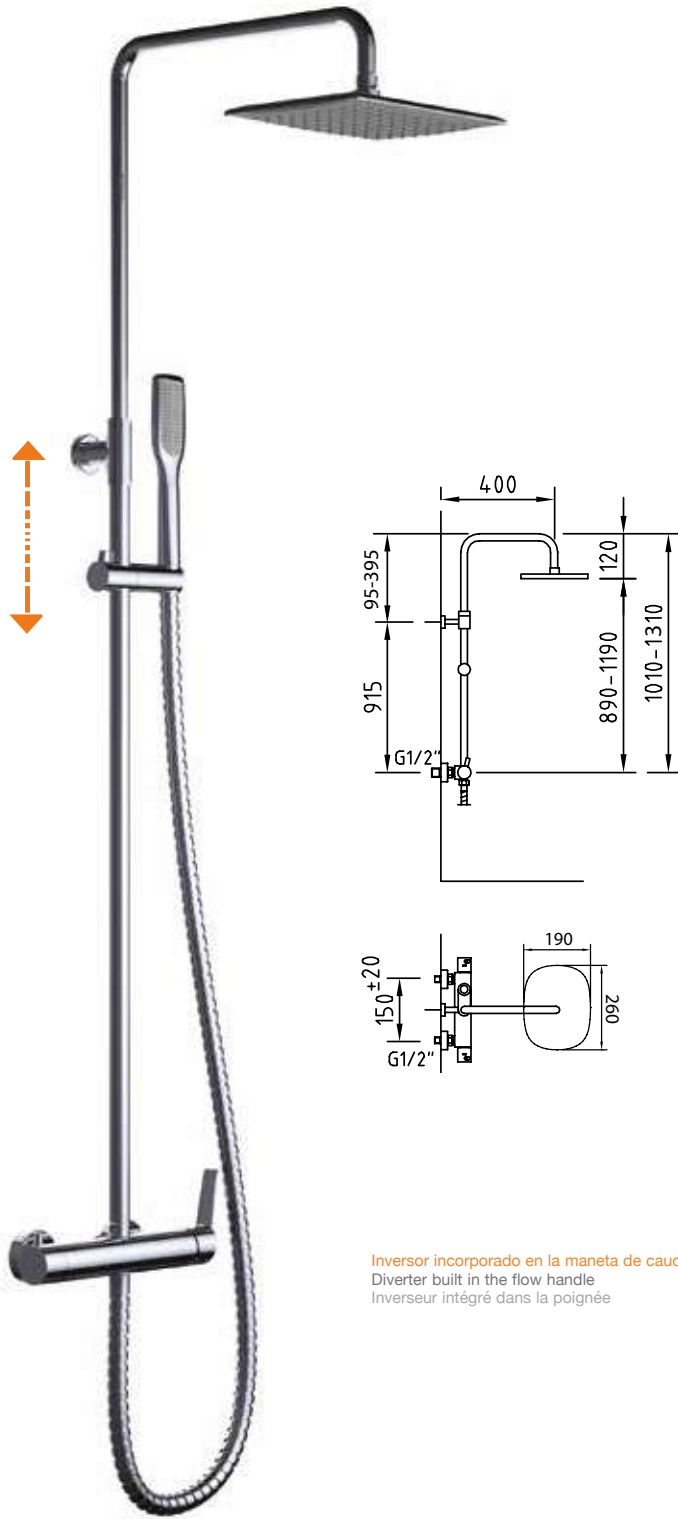

CONJUNTO DUCHA EXTENSIBLE
Extensible shower system
Colonne mitigeur bain-douche extensible

Mezclador de ducha con tubo extensible, soporte articulado.
 Adjustable shower system with diverter built in.
 Support douchette coulissant, inverseur intégré, pomme de douche, douchette et flexible

Incluye
 Includes
 Inclus



Ref.	€	
ec3 99727	360,00	-



Inversor incorporado en la maneta de caudal
 Diverter built in the flow handle
 Inverseur intégré dans la poignée

Productos relacionados
 Related products
 Produits connexes



SILVER HOSE _ 98880
 Flexible. Acabado en plata
 Flexible. Silver finish
 Flexible. Finition argent



FLEXIBLE _ 97114
 Cromado
 Chrome plated
 Chromé



STYLE _ 99610
 Teléfono ducha
 Handset
 Douchette



BEAM _ 60303
 Rociador ø 230mm
 Shower head
 Pomme de douche



60185
Lavabo 65
Basin Mixer
Mitiger Lavabo



Start urban

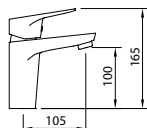

LAVABO 100

Tall basin mixer 100 | Mitigeur lavabo 100

Mezclador con aireador y flexibles M-10 3/8" x 420 mm.
Mixer, aerator, flexible hoses M-10 3/8" x 420 mm.
Mitigeur lavabo, aérateur, raccords flexibles M-10 3/8" x 420 mm

	Ref.	€	📦
	99205	77,00	12
	99206	79,00	12
	99207	81,00	12

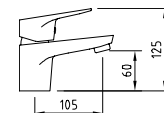
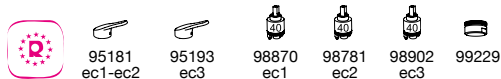

LAVABO 60

Basin mixer 60 | Mitigeur lavabo 60

Mezclador con aireador y flexibles M-10 3/8" x 420 mm.
Mixer, aerator, flexible hoses M-10 3/8" x 420 mm.
Mitigeur lavabo, aérateur, raccords flexibles M-10 3/8" x 420 mm

	Ref.	€	📦
	99153	67,00	12
	98918	69,00	12
	98610	71,00	12

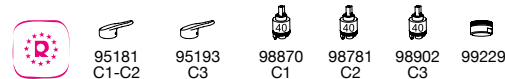

Productos relacionados Related products Produits connexes



urban_99459
Accesorios de baño
Bathroom accessories
Accessoires de salle de bain



LEO_98674
Válvula desagüe Universal
Universal drain quick-clac
Vidage Universel



ELEGANCE_96174
Sifón botella latón
Brass bottle trap
Siphon laiton



METÁLICO_99127
Desagüe automático
Pop-up
Vidage automatique

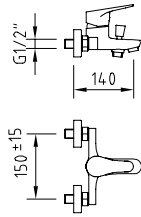

BAÑO-DUCHA

Bath-shower mixer | Mitigeur bain-douche

Mezclador baño-ducha, aireador, inversor automático
Bath-shower mixer, aerator, automatic diverter.
Mitigeur bain-douche, aérateur, inverseur automatique

Incluye teléfono ducha, flexo y soporte
Includes handset, hose and holder
Inclus douche, flexible et support
(98342, 97670, 98208)

	ec1	98612	116,00	8
--	-----	-------	--------	---

Sin kit ducha
Without shower kit
Sans kit de douche

		C1	98645	101,00	8
--	--	----	-------	--------	---



95181



98870



98490



99231

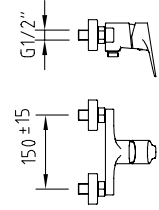

DUCHA

Shower mixer | Mitigeur Douche

Mezclador para ducha.
Shower mixer.
Mitigeur douche

Incluye teléfono ducha, flexo y soporte
Includes handset, hose and holder
Inclus douche, flexible et support
(98342, 97670, 98208)

	ec1	98613	95,00	8
--	-----	-------	-------	---

Sin kit ducha
Without shower kit
Sans kit de douche

		C1	98646	80,00	8
--	--	----	-------	-------	---



95181



98870

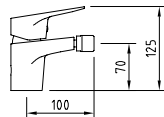

BIDÉ

Bidet mixer | Mitigeur bidet

Mezclador con aireador a rótula y flexibles M-10 3/8" x 420 mm.
Mixer, swivel aerator, flexible hoses M-10 3/8" x 420 mm.
Mitigeur bidet, aérateur rotule, raccords flexibles M-10 3/8" x 420 mm

	Ref.	€		
	ec2	98611	67,00	12



95181



98781



90026



SISTEMA ECONATURE.
Ahorro de agua. Dos posiciones de apertura de la maneta.

Econature system. Save water. Two positions of opening the handle.

Système Econature. Économie d'eau. Deux positions d'ouverture de la poignée.

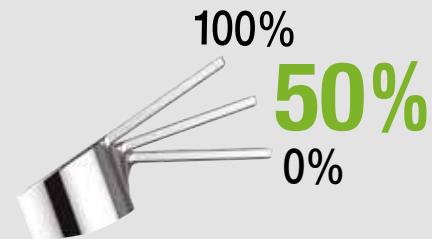

PAG. 236

DESIGN _ 40010
Válvula escuadra
Angle Valve
Robinet d'equerre



PAG. 105

NINE urban _ 97676
Ducha termostática
Thermostatic shower mixer
Mitigeur douche thermostatique



PAG. 140

CITY AIR _ 99624
Conjunto ducha
Shower kit
Kit douche



PAG. 188

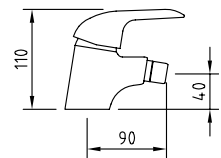
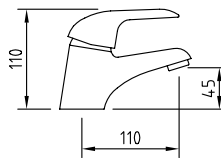

START urban_98614
Fregadero
Sink mixer
Mitigeur évier



LAVABO 45

Basin mixer 45 | Mitigeur lavabo 45

Mezclador alto con aireador y flexibles M-10 3/8" x 370 mm.
Mixer with aerator, flexible hoses M-10 3/8" x 370 mm.
Mitigeur lavabo, aérateur, raccords flexibles M-10 3/8" x 370 mm

	Ref.	€	📦
 	96340	51,00	12

  
96268 90760 90025

BIDÉ

Bidet mixer | Mélangeur bidet

Mezclador con aireador a rótula y flexibles M-10 3/8" x 370 mm.
Mixer, swivel aerator, flexible hoses M-10 3/8" x 370 mm.
Mitigeur bidet, aérateur rotule, raccords flexibles M-10 3/8" x 370 mm

	Ref.	€	📦
 	96341	51,00	12

  
96268 90760 90025

Productos relacionados Related products Produits connexes



PAG. 114

elegance _ 99451
Accesorios de baño
Bathroom accessories
Accessoires de salle de bain



PAG. 237

LEO _ 98674
Válvula desagüe Universal. Metálico
Universal drain quick-clac. Metallic
Vidage Universel. Métallique



PAG. 236

ELEGANCE _ 96174
Sifón botella latón
Brass bottle trap
Siphon laiton



PAG. 237

SINTÉTICO _ 99130
Desagüe automático
Pop-up
Vidage automatique



BAÑO-DUCHA
Bath-shower mixer | Mitigeur bain-douche

Mezclador baño-ducha, aireador, inversor automático
Bath-shower mixer, aerator, automatic diverter.
Mitigeur bain-douche, aérateur, inverseur

	Ref.	€	8
Incluye teléfono ducha, flexo y soporte Includes handset, hose and holder Inclus douchette, flexible et support (98342, 97670, 90011)	ACS ec1 96342	82,00	8
Sin kit ducha Without shower kit Sans kit de douche	ACS ec1 99799	72,00	8

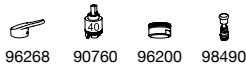

DUCHA
Shower mixer | Mitigeur Douche

Mezclador para ducha.
Shower mixer.
Mitigeur douche

	Ref.	€	8
Incluye teléfono ducha, flexo y soporte Includes handset, hose and holder Inclus douchette, flexible et support (98342, 97670, 90011)	ACS ec1 96343	67,00	8
Sin kit ducha Without shower kit Sans kit de douche	ACS ec1 99800	57,00	8

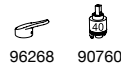

DURACIÓN MECÁNICA
Mechanic Duration
Durabilité mécanique



Ensayar la duración mecánica de las partes móviles mediante ciclos enteros en **cartuchos, caños e inversores**.

Test the duration of the mechanical moving parts by cycles on the cartridges, spouts and diverters.

Test d'endurance mécanique des éléments mobiles, cartouches, becs et inverseurs.



Cartucho/ Cartridge/ Cartouche
70.000

Caño / spout / bec
80.000

Inversor / diverter / inverseur
30.000



PAG. 105

NINE urban _ 97676
Ducha termostática
Thermostatic shower mixer
Mitigeur douche thermostatique



PAG. 140

CITY AIR _ 99624
Conjunto ducha
Shower kit
Kit douche



PAG. 194

PANAM elegance _ 96346
Fregadero mural
Wall mounted sink mixer
Mitigeur évier murale



PAG. 188

PANAM elegance _ 96344
Fregadero
Sink mixer
Mitigeur évier

Panam xtreme

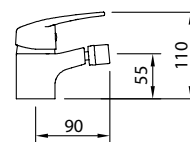
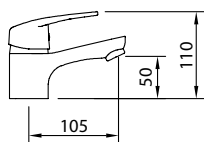



LAVABO 50

Basin mixer 50 | Mitigeur lavabo 50

Mezclador alto con aireador y flexibles M-10 3/8" x 370 mm.
Mixer with aerator, flexible hoses M-10 3/8" x 370 mm.

Mitigeur lavabo, aérateur, raccords flexibles M-10 3/8" x 370 mm

	Ref.	€	
  ec1	98141	51,00	12



95172



98237



90025

PAG.
114

elegance _ 99451

Accesorios de baño
Bathroom accessories
Accessoires de salle de bain

BIDÉ

Bidet mixer | Mitigeur bidet

Mezclador con aireador a rótula y flexibles M-10 3/8" x 370 mm.

Mixer, swivel aerator, flexible hoses M-10 3/8" x 370 mm.

Mitigeur bidet, aérateur rotule, raccords flexibles M-10 3/8" x 370 mm

	Ref.	€	
  ec1	98142	51,00	12



95172



98237



99232

PAG.
236

ELEGANCE _ 96174

Sifón botella latón
Universal drain quick-clac. Metallic
Vidage Universel. Métallique



PAG.
237

SINTÉTICO _ 99130

Desagüe automático
Pop-up
Vidage automatique

Productos
relacionados
Related products
Produits connexes



PAG.
114

elegance _ 99451

Accesorios de baño
Bathroom accessories
Accessoires de salle de bain



PAG.
237

LEO _ 98674

Válvula desagüe Universal. Metálico
Universal drain quick-clac. Metallic
Vidage Universel. Métallique



PAG.
236

ELEGANCE _ 96174

Sifón botella latón
Universal drain quick-clac. Metallic
Vidage Universel. Métallique

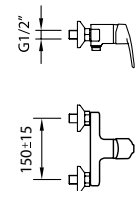
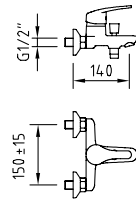

BAÑO-DUCHA
Bath-shower mixer | Mitigeur bain-douche

Mezclador baño-ducha, aireador, inversor automático
Bath-shower mixer, aerator, automatic diverter.
Mitigeur bain-douche, aérateur, inverseur

Incluye teléfono ducha, flexo y soporte
Includes handset, hose and holder
Inclus douchette, flexible et support
(98342, 97670, 98343)

	Ref.	€	
	ec1 98143	82,00	8
	ec1 99801	72,00	8

Sin kit ducha
Without shower kit
Sans kit de douche

DUCHA
Shower mixer | Mitigeur Douche

Mezclador para ducha.
Shower mixer.
Mitigeur douche

Incluye teléfono ducha, flexo y soporte
Includes handset, hose and holder
Inclus douchette, flexible et support
(98342, 97670, 98343)

	Ref.	€	
	ec1 98144	67,00	8
	ec1 99802	57,00	8

Sin kit ducha
Without shower kit
Sans kit de douche

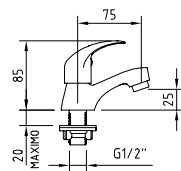
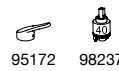
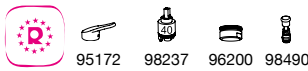

GRIFO SIMPLE REPISA
Single handdle washbain tap | Robinet simple

Grifo de repisa con aireador.
Deck mounted single basin tap, with aerator.
Robinet lavabo, aérateur, 1/2"

	Ref.	€	
	98458	26,00	48



DURACIÓN MECÁNICA
Mechanic Duration
Durabilité mécanique



Ensayar la duración mecánica de las partes móviles mediante ciclos enteros en **cartuchos, caños e inversores**.

Test the duration of the mechanical moving parts by cycles on the cartridges, spouts and diverters.

Test d'endurance mécanique des éléments mobiles, cartouches, becs et inverseurs.



Cartucho/ Cartridge / Cartouche
70.000



PAG. 129

iclever 2 _ 98711 + 98726
Ducha empotrada 1 vía
Concealed bath-shower 1 outlet diverter
Douche encastré 1 voie



PAG. 131

iclever 2 _ 98711 + 98741
Ducha empotrada 2 vías
Concealed bath-shower 2 outlet diverter
Douche encastré 2 voies



PAG. 105

NINE urban _ 97676
Ducha termostática
Thermostatic shower mixer
Mitigeur douche thermostatique



PAG. 188

PANAM xtreme_98767
Fregadero
Sink mixer
Mitigeur évier

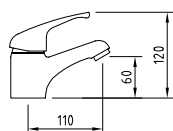

Panam urban



LAVABO 60

Basin mixer 60 | Mitigeur lavabo 60

Mezclador alto con aireador y flexibles M-10 3/8" x 370 mm.
Mixer with aerator, flexible hoses M-10 3/8" x 370 mm.
Mitigeur lavabo, aérateur, raccords flexibles M-10 3/8" x 370 mm

	Ref.	€	📦
	94695	51,00	12
	96541	59,00	12
	97935	67,00	12

Con desagüe sintético
With synthetic pop-up waste
Avec vidage synthétique

Con desagüe metálico
With metallic pop-up waste
Avec vidage métallique

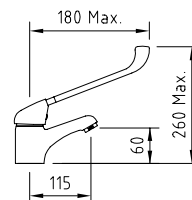

GRIFERÍA CON MANETA GERONTOLÓGICA

Sink mixer with medical lever | Mitigeur lavabo avec manette médicale

Mezclador con aireador, con palanca gerontológica y flexibles M-10 3/8" x 370 mm.
Mixer with medical lever operated with aerator, flexible hoses M-10 3/8" x 370 mm.
Mitigeur lavabo, manette médicale, aérateur, raccords flexibles M-10 3/8" x 370 mm

	Ref.	€	📦
	94694	59,00	12

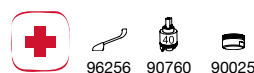

Productos relacionados

Related products
Produits connexes



PAG. 118

urban _ 99459
Accesorios de baño
Bathroom accessories
Accessoires de salle de bain



PAG. 237

LEO _ 98674
Válvula desagüe Universal. Metálico
Universal drain quick-clac. Metallic
Vidage Universel. Métallique



PAG. 236

ELEGANCE _ 96174
Sifón botella latón
Brass bottle trap
Siphon laiton



PAG. 237

SINTÉTICO _ 99130
Desagüe automático
Pop-up
Vidage automatique



BAÑO-DUCHA
Bath-shower mixer | Mitigeur bain-douche

Mezclador baño-ducha, aireador, inversor automático
Bath-shower mixer, aerator, automatic diverter.
Mitigeur bain-douche, aérateur, inverseur

	Ref.	€	
Incluye teléfono ducha, flexo y soporte Includes handset, hose and holder Inclus douchette, flexible et support (98342, 97670, 90011)	ACS ec1 94697	82,00	8
Sin kit ducha Without shower kit Sans kit de douche	ACS ec1 98817	72,00	8

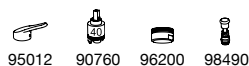

DUCHA
Shower mixer | Mitigeur Douche

Mezclador para ducha.
Shower mixer.
Mitigeur douche

	Ref.	€	
Incluye teléfono ducha, flexo y soporte Includes handset, hose and holder Inclus douchette, flexible et support (98342, 97670, 90011)	ACS ec1 94698	67,00	8
Sin kit ducha Without shower kit Sans kit de douche	ACS ec1 98818	57,00	8

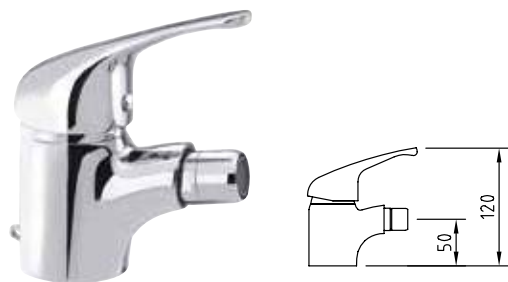

BIDÉ
Bidet mixer | Mitigeur bidet

Mezclador con aireador a rótula y flexibles M-10 3/8" x 370 mm.
Mixer, swivel aerator, flexible hoses M-10 3/8" x 370 mm.
Mitigeur bidet, aérateur rotule, raccords flexibles M-10 3/8" x 370 mm

	Ref.	€	
ACS ec1	94696	51,00	12

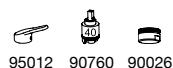

DURACIÓN MECÁNICA
Mechanic Duration
Durabilité mécanique

AENOR
Producto Certificado

Ensayar la duración mecánica de las partes móviles mediante ciclos enteros en **cartuchos, caños e inversores**.

Test the duration of the mechanical moving parts by cycles on the cartridges, spouts and diverters.

Test d'endurance mécanique des éléments mobiles, cartouches, becs et inverseurs.

Cartucho/ Cartridge / Cartouche
70.000



NINE urban _ 97676
Ducha termostática
Thermostatic shower mixer
Mitigeur douche thermostatique



ATLAS _ 97800
Ducha higiénica
Shattaf
Douche hygiénique

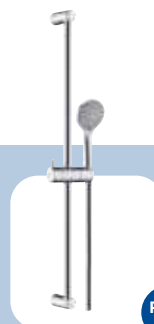

CITY AIR _ 99624
Conjunto ducha
Shower kit
Kit douche



PANAM urban _ 92350
Fregadero
Sink mixer
Mitigeur évier

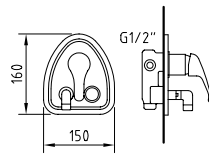

BAÑO DUCHA EMPOTRAR 2 VÍAS

Wall mounted shower mixer with diverter 2 outlet diverter | Mitigeur à encastrer / 2 voies

Mezclador empotrable de 1/2" para ducha con codo giratorio.
 Concealed mixer 1/2" for shower with swivel elbow.
 Mitigeur encastré, 1/2", inverseur automatique

Incluye teléfono ducha, flexo y soporte
 Includes handset, hose and holder
 Inclus douche, flexible et support
 (96108, 97670, 90011)

	Ref.	€	📦
ec1	96066	114,00	8

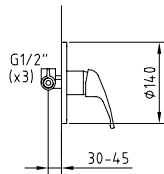

DUCHA EMPOTRAR 1 VÍA

Wall mounted shower mixer 1 outlet diverter | Mitigeur à encastrer / 1 voie

Mezclador empotrable de 1/2" para ducha
 Concealed shower mixer 1/2"
 Mitigeur encastré, 1/2"

	Ref.	€	📦
ec1	98455	72,00	12

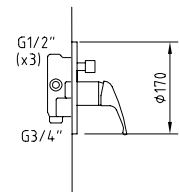

BAÑO DUCHA EMPOTRAR 2 VÍAS

Wall mounted bath-shower mixer 2 outlet diverter | Mitigeur à encastrer / 2 voies

Mezclador empotrable de 1/2" para baño-ducha, inversor automático
 Concealed bath-shower mixer 1/2", automatic diverter
 Mitigeur encastré, 1/2", inverseur automatique

	Ref.	€	📦
ec1	98456	112,00	12



PAG. 129

iclever 2 _ 98711 + 98724
 Ducha empotrada 1 vía
 Concealed bath-shower 1 outlet diverter
 Douche encastré 1 voie



PAG. 131

iclever 2 _ 98711 + 98739
 Ducha empotrada 2 vías
 Concealed bath-shower 2 outlet diverter
 Douche encastré 2 voies



PAG. 138

ROUND AIR _ 99604 + LUZIA _ 96153
 Rociador y brazo
 Shower head and arm
 Pomme de douche et bras



PAG. 148

CAIMAN urban _ 98236
 Salida flexo mural con soporte
 Wall hose bib outlet with holder
 Sortie flexible murale avec support



94695 | Lavabo 60
Basin Mixer
Mitiger Lavabo

S12 elegance

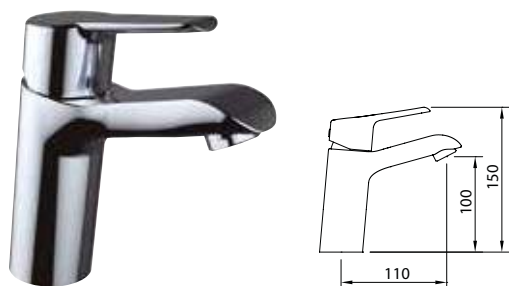

LAVABO 100

Tall basin mixer 100 | Mitigeur lavabo 100

Mezclador con aireador y flexibles M-10 3/8" x 420 mm.
Mixer, aerator, flexible hoses M-10 3/8" x 420 mm.
Mitigeur lavabo, aérateur, raccords flexibles M-10 3/8" x 420 mm

	Ref.	€	📦
ec1	99838	61,00	12
ec2	99320	63,00	12
ec3	99326	65,00	12

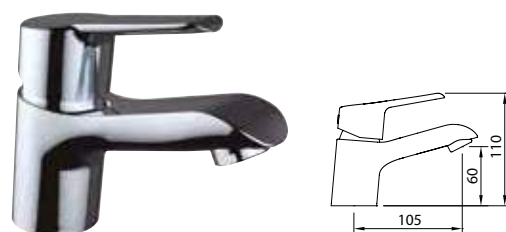

LAVABO 60

Basin mixer 60 | Mitigeur lavabo 60

Mezclador con aireador y flexibles M-10 3/8" x 370 mm.
Mixer, aerator, flexible hoses M-10 3/8" x 370 mm.
Mitigeur Lavabo, aérateur, raccords flexibles M-10 3/8" x 370 mm

	Ref.	€	📦
ec1	99835	51,00	12
ec2	99317	53,00	12
ec3	99323	55,00	12



Productos relacionados

Related products
Produits connexes



PAG. 247

PEANA _ 60559
Base plástica
Plastic base
Base en plastique



PAG. 237

LEO _ 99398
Válvula desagüe Universal
Universal drain quick-clac
Vidage Universel



PAG. 236

ELEGANCE _ 96174
Sifón botella latón
Brass bottle trap
Siphon laiton



PAG. 237

SINTÉTICO _ 99130
Desagüe automático
Pop-up
Vidage automatique

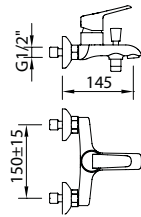

BAÑO-DUCHA
Bath-shower mixer | Mitigeur bain-douche

Mezclador baño-ducha, aireador, inversor automático
Bath-shower mixer, aerator, automatic diverter.
Mitigeur bain-douche, aérateur, inverseur

Incluye teléfono ducha, flexo y soporte
Includes handset, hose and holder
Inclus douchette, flexible et support
(98342, 97670, 98343)

	Ref.	€	📦
	99844	82,00	6+6

Sin kit ducha
Without shower kit
Sans kit de douche

	99845	72,00	6+6
--	-------	-------	-----



95230



99817



96200



98490

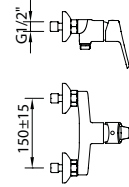

DUCHA
Shower mixer | Mitigeur Douche

Mezclador para ducha.
Shower mixer.
Mitigeur douche

Incluye teléfono ducha, flexo y soporte
Includes handset, hose and holder
Inclus douchette, flexible et support
(98342, 97670, 98343)

	Ref.	€	📦
	99846	67,00	6+6

Sin kit ducha
Without shower kit
Sans kit de douche

	99847	57,00	6+6
--	-------	-------	-----



95230



99817

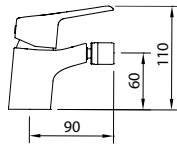

BIDÉ
Bidet mixer | Mitigeur bidet

Mezclador con aireador a rótula y flexibles M-10 3/8" x 370 mm.
Mixer, swivel aerator, flexible hoses M-10 3/8" x 370 mm.
Mitigeur bidet, aérateur rotule, raccords flexibles M-10 3/8" x 370 mm

	Ref.	€	📦
	99841	51,00	12



95230



99817



99232



SISTEMA ECONATURE.
Ahorro de agua. Dos posiciones de apertura de la maneta.

Econature system. Save water. Two positions of opening the handle.

Système Econature. Économie d'eau. Deux positions d'ouverture de la poignée.

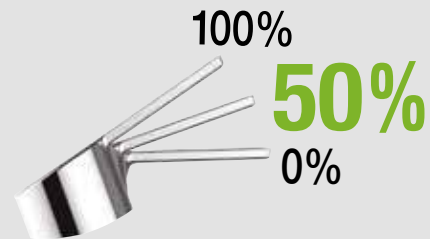

PAG. 114

elegance_99451
Accesorios de baño
Bathroom accessories
Accessoires de salle de bain



PAG. 140

CITY AIR_99624
Conjunto ducha
Shower kit
Kit douche



PAG. 195

S12 elegance_99849
Fregadero mural
Wall mounted sink mixer
Mitigeur évier murale



PAG. 189

S12 elegance_99848
Fregadero
Sink mixer
Mitigeur évier

S12 xtreme

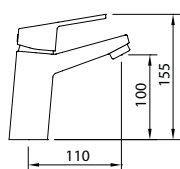

LAVABO 100

Tall basin mixer 100 | Mitigeur lavabo 100

Mezclador con aireador y flexibles M-10 3/8" x 420 mm.

Mixer, aerator, flexible hoses M-10 3/8" x 420 mm.

Mitigeur lavabo, aérateur, raccords flexibles M-10 3/8" x 420 mm

	Ref.	€	📦
ACS ec1	99823	61,00	12
ACS ec2	99245	63,00	12
ACS ec3	99251	65,00	12

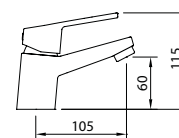

LAVABO 60

Basin mixer 60 | Mitigeur lavabo 60

Mezclador alto con aireador y flexibles M-10 3/8" x 370 mm.

Mixer with aerator, flexible hoses M-10 3/8" x 370 mm.

Mitigeur lavabo, aérateur, raccords flexibles M-10 3/8" x 370 mm

	Ref.	€	📦
ACS ec1	99820	51,00	12
ACS ec2	99242	53,00	12
ACS ec3	99248	55,00	12

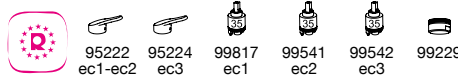

Productos relacionados

Related products
Produits connexes

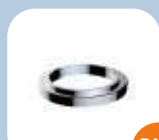

PAG. 247

PEANA _ 60559
Base plástica
Plastic base
Base en plastique



PAG. 237

LEO _ 99398
Válvula desagüe Universal
Universal drain quick-clac
Vidage Universel



PAG. 236

XTREME _ 96173
Sifón botella latón
Brass bottle trap
Siphon laiton



PAG. 237

SINTÉTICO _ 99130
Desagüe automático
Pop-up
Vidage automatique



BAÑO-DUCHA
Bath-shower mixer | Mitigeur bain-douche

Mezclador baño-ducha, aireador, inversor automático
Bath-shower mixer, aerator, automatic diverter.
Mitigeur bain-douche, aérateur, inverseur

	Ref.	€	
Incluye teléfono ducha, flexo y soporte Includes handset, hose and holder Inclus douchette, flexible et support (98342, 97670, 98343)	99829	82,00	6+6
Sin kit ducha Without shower kit Sans kit de douche	99830	72,00	6+6



DUCHA
Shower mixer | Mitigeur Douche

Mezclador para ducha.
Shower mixer.
Mitigeur douche

	Ref.	€	
Incluye teléfono ducha, flexo y soporte Includes handset, hose and holder Inclus douchette, flexible et support (98342, 97670, 98343)	99831	67,00	6+6
Sin kit ducha Without shower kit Sans le kit de douche	99832	57,00	6+6



BIDÉ
Bidet mixer | Mitigeur bidet

Mezclador con aireador a rótula y flexibles M-10 3/8" x 370 mm.
Mixer, swivel aerator, flexible hoses M-10 3/8" x 370 mm.
Mitigeur bidet, aérateur rotule, raccords flexibles M-10 3/8" x 370 mm

	Ref.	€	
	99826	51,00	12



SISTEMA COLD OPEN DE APERTURA EN FRÍO. AHORRA EN AGUA CALIENTE.

Cold Open system. It opens in cold position.
You save energy.
Cold Open. Système d'ouverture en eau froide pour faire des économies d'énergie.



xtreme_98655
Accesorios de baño
Bathroom accessories
Accessoires de salle de bain

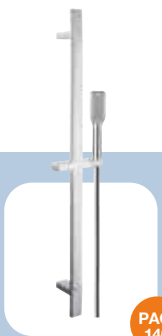

TREND_99626
Conjunto barra ducha
Sliding bar set
Ensemble barre douche



S12 xtreme_99834
Fregadero mural
Wall mounted sink mixer
Mitigeur évier murale



S12 xtreme_99833
Fregadero
Sink mixer
Mitigeur évier

S12 urban



LAVABO 60

Basin mixer 60 | Mitigeur lavabo 60

Mezclador alto con aireador y flexibles M-10 3/8" x 370 mm.
Basin mixer with aerator, flexible hoses M-10 3/8" x 370 mm.
Mitigeur lavabo, aérateur, raccords flexibles M-10 3/8" x 370 mm

	Ref.	€	📦
	98330	51,00	12
	99161	55,00	12
	98800	57,00	12

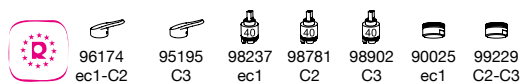

LAVABO 60 CON MANETA GERONTOLÓGICA

Basin mixer 60 with medical lever

Mitigeur lavabo 60 avec manette médicale

Mezclador con aireador, con palanca gerontológica y flexibles M-10 3/8" x 370 mm.
Mixer with medical lever operated with aerator, flexible hoses M-10 3/8" x 370 mm.
Mitigeur lavabo, manette médicale, aérateur, raccords flexibles M-10 3/8" x 370 mm

	Ref.	€	📦
	99214	59,00	12

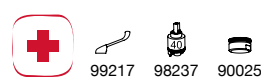

Productos relacionados

Related products
Produits connexes



PAG. 118

urban _ 99459
Accesorios de baño
Bathroom accessories
Accessoires de salle de bain



PAG. 237

LEO _ 99398
Válvula desagüe Universal
Universal drain quick-clac
Vidage Universel



PAG. 236

ELEGANCE _ 96174
Sifón botella latón
Brass bottle trap
Siphon laiton



PAG. 237

SINTÉTICO _ 99130
Desagüe automático
Pop-up
Vidage automatique



BAÑO-DUCHA
Bath-shower mixer | Mitigeur bain-douche

Mezclador baño-ducha, aireador, inversor automático
Bath-shower mixer, aerator, automatic diverter.
Mitigeur bain-douche, aérateur, inverseur

	Ref.	€	📦
Incluye teléfono ducha, flexo y soporte Includes handset, hose and holder Inclus douchette, flexible et support (98342, 97670, 98343)	ACS ec1 98332	82,00	8
Sin kit ducha Without shower kit Sans kit de douche	ACS ec1 98340	72,00	8



DUCHA
Shower mixer | Mitigeur Douche

Mezclador para ducha.
Shower mixer.
Mitigeur douche

	Ref.	€	📦
Incluye teléfono ducha, flexo y soporte Includes handset, hose and holder Inclus douchette, flexible et support (98342, 97670, 98343)	ACS ec1 98333	67,00	8
Sin kit ducha Without shower kit Sans kit de douche	ACS ec1 98341	57,00	8

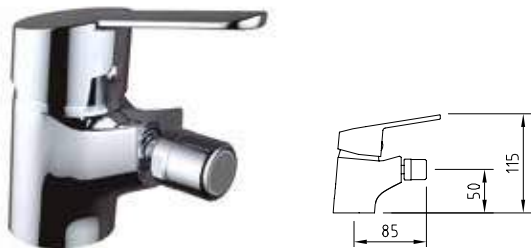

BIDÉ
Bidet mixer | Mitigeur bidet

Mezclador con aireador a rótula y flexibles M-10 3/8" x 370 mm.
Mixer, swivel aerator, flexible hoses M-10 3/8" x 370 mm.
Mitigeur bidet, aérateur rotule, raccords flexibles M-10 3/8" x 370 mm

	Ref.	€	📦
ACS ec1 98331	51,00	12	



GRIFERÍA SIMPLE REPISA
Single handle washin tap / Robinet simple

Grifo de repisa, con aireador.
Deck mounted single faucet, with aerator.
Robinet lavabo, aérateur, 1/2"

	Ref.	€	📦
ACS ec1 98449	26,00	48	



NINE SLIM urban_60414
Ducha térmica
Thermostatic shower mixer
Mitigeur douche thermostatique

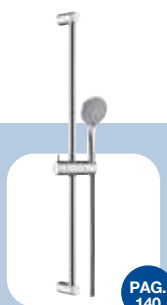

CITY AIR_99624
Conjunto ducha
Shower kit
Kit douche



Iclever 2_98711+98725
Ducha empotrada 1 via
Concealed bath-shower 1 outlet diverter
Douche encastré 1 voie



S12 urban_98334
Fregadero
Sink mixer
Mitigeur évier

With2 guayama

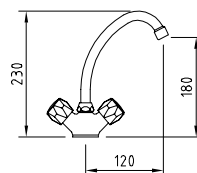
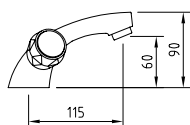

LAVABO 60 Basin mixer 60 | Mélangeur lavabo 60

Mezclador con aireador y flexibles M-10 3/8" x 370 mm.
Mixer, aerator, flexible hoses M-10 3/8" x 370 mm.
Mélangeur lavabo, aérateur, raccords flexibles M-10 3/8" x 370 mm

	Ref.	€	📦
	96084	57,00	12



96232 96233 96208 90025

LAVABO ALTO 180 Tall basin mixer 180 | Mélangeur lavabo haut 180

Mezclador con aireador, caño conformado giratorio, flexibles M-10 3/8" x 370 mm.
Mixer with aerator, swivel tube spout, flexible hoses M-10 3/8" x 370 mm.
Mélangeur lavabo, aérateur, raccords flexibles M-10 3/8" x 370 mm

	Ref.	€	📦
	98354	50,00	12



96232 96233 96208 90026

Productos relacionados Related products Produits connexes



PAG. 120

Urban _ 98650
Accesorios de baño
Bathroom accessories
Accessoires de salle de bain



PAG. 237

LEO _ 99398
Válvula desagüe Universal
Universal drain quick-clac
Vidage Universel



PAG. 236

SIFÓN BOTELLA LATÓN _ 90755
Brass bottle trap
Siphon laiton



PAG. 236

DESIGN _ 40010
Válvula escuadra
Angle Valve
Robinet d'équerre

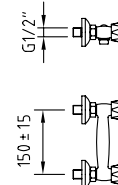
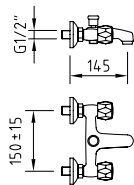

BAÑO-DUCHA

Bath-shower mixer | Mélangeur bain-douche

Mezclador baño-ducha, aireador, inversor automático
 Bath-shower mixer, aerator, automatic diverter.
 Mélangeur bain-douche, aérateur, inverseur automatique

Incluye teléfono ducha, flexo y soporte
 Includes handset, hose and holder
 Inclus douche, flexible et support
 (98342, 97670, 98343)

	Ref.	€	📦
	96086	84,00	8
	97933	74,00	8

Sin kit ducha
 Without shower kit
 Sans kit de douche

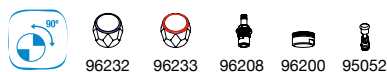

DUCHA

Shower mixer | Mélangeur douche

Mezclador para ducha.
 Shower mixer.
 Mélangeur douche

Incluye teléfono ducha, flexo y soporte
 Includes handset, hose and holder
 Inclus douche, flexible et support
 (98342, 97670, 98343)

	Ref.	€	📦
	96087	59,00	12
	97934	49,00	8

Sin kit ducha
 Without shower kit
 Sans kit de douche

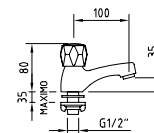
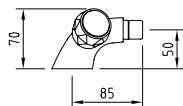

BIDÉ

Bidet mixer | Mélangeur bidet

Mezclador con aireador a rótula y flexibles M-10 3/8" x 370 mm.
 Mixer, swivel aerator, flexible hoses M-10 3/8" x 370 mm.
 Mélangeur bidet, aérateur rotule, raccords flexibles M-10 3/8" x 370 mm

	Ref.	€	📦
	96085	57,00	12

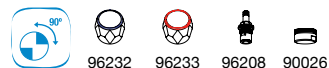

GRIFERÍA SIMPLE REPISA 35

Single tap 35 | Robinet simple 35

Grifo de repisa, con aireador, índice de agua fría.
 Deck mounted single basin faucet, with aerator, cold water indice.
 Robinet lavabo, aérateur.

	Ref.	€	📦
	96097	26,00	24

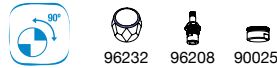

PAG. 104

NINE SLIM urban_60414
 Ducha termostática
 Thermostatic shower mixer
 Mitigeur douche thermostatique



PAG. 140

CITY AIR_99624
 Conjunto ducha
 Shower kit
 Kit douche



PAG. 213

WITH2 guayama_98451
 Grifería simple mural
 Wall mounted single tap
 Robinet simple mural



PAG. 198

WITH2 guayama_96088
 Fregadero
 Sink mixer
 Mitigeur évier

Nine urban



NEW

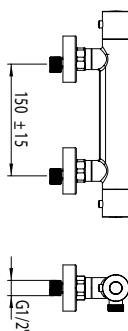

NINE SLIM urban

DUCHA TERMOSTÁTICA

Thermostatic shower mixer | Mitigeur douche thermostatique

Mezclador termostático para ducha.
Thermostatic shower mixer.
Mitigeur douche thermostatique, aérateur.

Incluye teléfono ducha, flexo y soporte
Includes handset, hose and holder
Inclus douche, flexible et support
(98342, 98342, 97670)

Sin kit ducha
Without shower set
Sans kit de douche

	Ref.	€	
	60414	153,00	6
	60415	138,00	6



99652 97385

Productos relacionados Related products Produits connexes



PAG. 118

urban_99459
Accesorios de baño
Bathroom accessories
Accessoires de salle de bain



PAG. 43

NINE elegance 60154
Ducha termostática
Thermostatic shower mixer
Mitigeur douche thermostatique

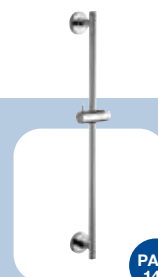

PAG. 147

STYLE_99621
Barra de ducha
Sliding bar
Barre de douche



Inversor incorporado en la maneta de caudal
Diverter built in the flow handle
Inverseur intégré dans la poignée

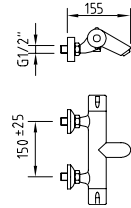

BAÑO-DUCHA TERMOSTÁTICO
Thermostatic bath-shower mixer
Mitigeur bain-douche thermostatique
Mezclador termostático para baño-ducha.
Thermostatic bath-shower mixer.
Mitigeur bain-douche thermostatique, aérateur, inversor cerámico
intégré

Incluye teléfono ducha, flexo y soporte
Includes handset, hose and holder
Inclus douche, flexible et support
(96108, 97670, 90011)

Sin kit ducha
Without shower set
Sans kit de douche

Ref.	€	📦
98822	196,00	6
98928	181,00	6



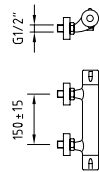

98027 90027 98776



DUCHA TERMOSTÁTICA
Thermostatic shower mixer
Mitigeur douche thermostatique
Mezclador termostático para ducha.
Thermostatic shower mixer.
Mitigeur douche thermostatique

Incluye teléfono ducha, flexo y soporte
Includes handset, hose and holder
Inclus douche, flexible et support
(96108, 97670, 90011)

Sin kit ducha
Without shower set
Sans kit de douche

Ref.	€	📦
 97676	163,00	-
 60325	163,00	-
 97692	148,00	-
 60326	148,00	-



Códigos Aenor. Disponible a partir de Mayo 2018
Aenor codes. Available from May 2018
Codes Aenor. Disponible à partir de Mai 2018

98027 97385



99613
Teléfono de ducha
Handset
Douchette

99621
Barra de ducha
Sliding bar
Barre de douche

98149
Ducha termostática
Thermostatic shower mixer
Mitigeur douche thermostatique



PAG. 143

STYLE _ 99613
Teléfono de ducha
Handset
Douchette



PAG. 45

NINE XTREME _ 60133
Ducha termostática
Thermostatic shower mixer
Mitigeur douche thermostatique

Sistema COLD TOUCH Anti-quemaduras



Inversor incorporado en la maneta de caudal
Diverter built in the flow handle
Inverseur intégré dans la poignée

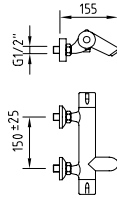

Sistema COLD TOUCH Anti-quemaduras

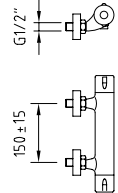

BAÑO-DUCHA TERMOSTÁTICO

Thermostatic bath-shower mixer | Mitigeur bain-douche thermostatique

Mezclador termostático para baño-ducha, cold touch.
Thermostatic bath-shower mixer, cold touch.
Mitigeur bain-douche thermostatique, aérateur, inverseur céramique intégré, corps froid

	Ref.	€	
Incluye teléfono ducha, flexo y soporte Includes handset, hose and holder Inclus douchette, flexible et support (96108, 97670, 98208)	98823	211,00	6
Sin kit ducha Without shower set Sans kit de douche	98929	196,00	6



DUCHA TERMOSTÁTICA

Thermostatic shower mixer | Mitigeur douche thermostatique

Mezclador termostático para ducha, cold touch.
Thermostatic shower mixer, cold touch.
Mitigeur douche thermostatique, aérateur, corps froid

	Ref.	€	
Incluye teléfono ducha, flexo y soporte Includes handset, hose and holder Inclus douchette, flexible et support (96108, 97670, 98208)	98478	178,00	6
Sin kit ducha Without shower set Sans kit de douche	98149	163,00	6



SISTEMA COLD TOUCH ANTI-QUEMADURAS.
Permiten que en ningún caso el cuerpo se caliente y queme.
Ideal para la seguridad infantil.

Cold touch system. Maintain the body cold. Ideal for the child security.
Robinetterie anti-brûlures. Évite que les corps de nos douches et bains douches ne chauffent et ne brûlent.
Idéal pour la sécurité des enfants.



STANDARD SYSTEM

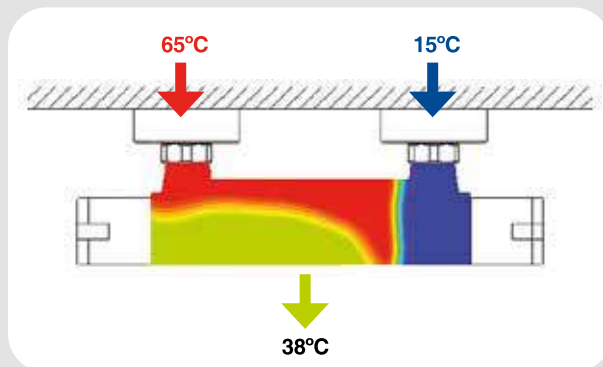

COLD TOUCH SYSTEM

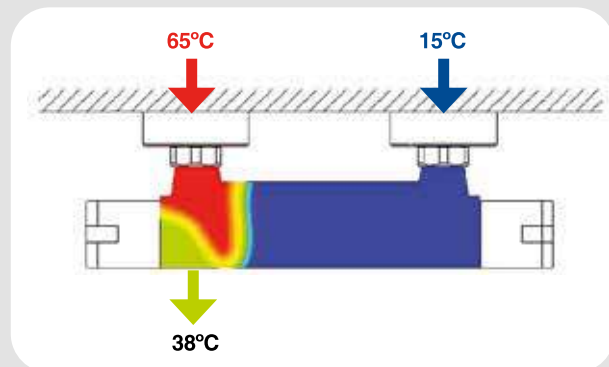



Inversor incorporado en la maneta de caudal
Diverter built in the flow handle
Inverseur intégré dans la poignée

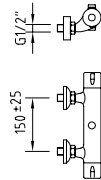

GRIFERÍA PARA DUCHA TUBO EXTENSIBLE
Shower mixer for adjustable shower bar
Mitigeur douche thermostatique double sortie

Recambio termostático para 98761-98762-98995-60327-60328-60412-60413. 2 salidas.
Thermostatic replacement for 98761-98762-98995-60327-60328-60412-60413. 2 outlets.
Robinetterie thermostatique douche pour 98761-98762-98995-60327-60328-60412-60413. 2 sorties.

	Ref.	€	
Sin kit ducha Without shower set Sans kit de douche	98763	168,00	6



98027 98776

CONJUNTO DE DUCHA TERMOSTÁTICO
Thermostatic shower system
Colonne thermostatique douche extensible

Mezclador termostático de ducha con tubo extensible (98517), soporte articulado deslizante.
Adjustable thermostatic shower system (98517) with diverter built.
Support douchette coulissant, inverseur céramique, pomme de douche, douchette et flexible

Incluye
Includes
Inclus



Circular
98518



Caiman
90796



1,75 m
97670



Ceilan
96264



Support
98497

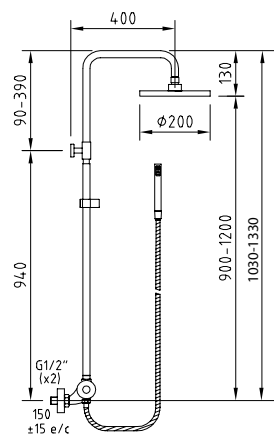

	Ref.	€	
	98761	416,00	4
	60327	416,00	-



Códigos Aenor. Disponible a partir de Mayo 2018
Aenor codes. Available from May 2018
Codes Aenor. Disponible à partir de Mai 2018



98027 98776

Inversor incorporado en la maneta de caudal
Diverter built in the flow handle
Inverseur intégré dans la poignée

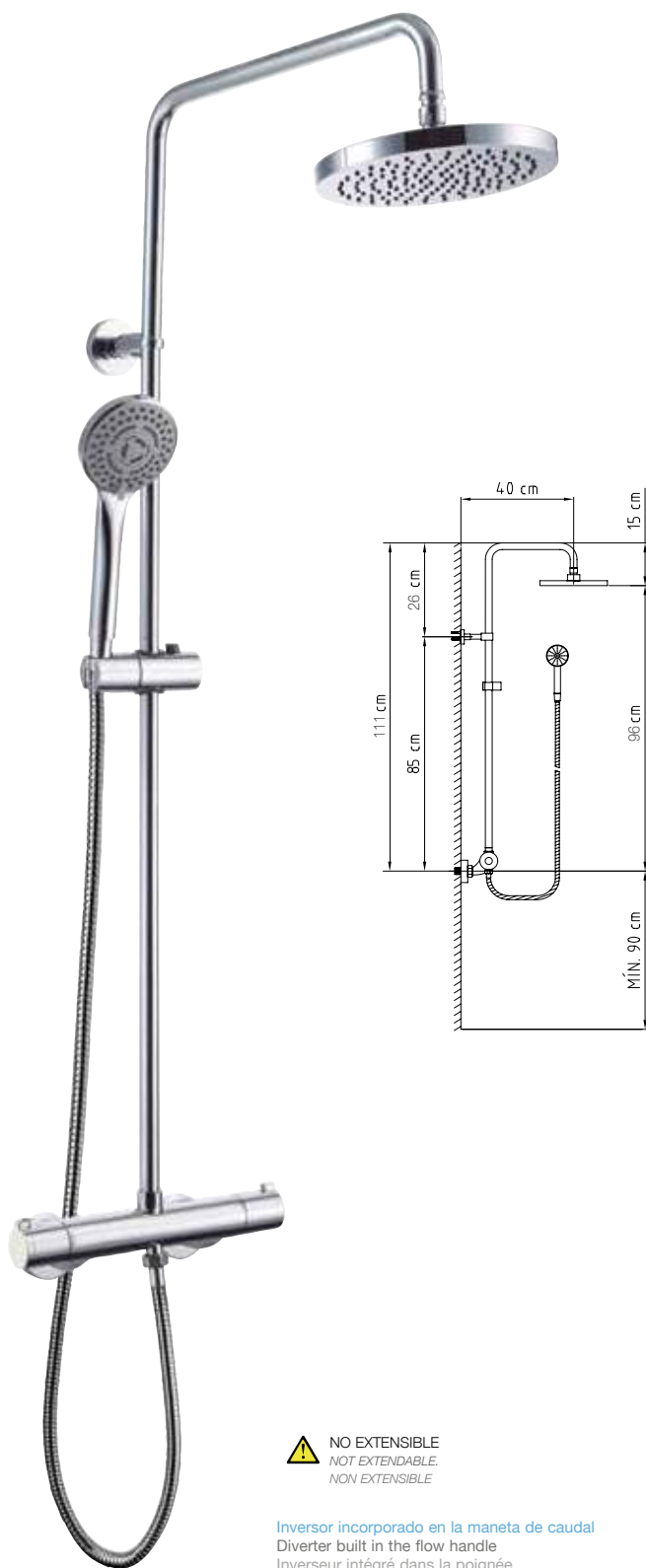

! NO EXTENSIBLE
NOT EXTENDABLE.
NON EXTENSIBLE

Inversor incorporado en la maneta de caudal
Diverter built in the flow handle
Inverseur intégré dans la poignée

CONJUNTO DE DUCHA TERMOSTÁTICO
Thermostatic shower system
Colonne thermostatique douche

Mezclador termostático de ducha soporte articulado deslizable.
Thermostatic shower valve with diverter built in.
Support douchette coulissant, inverseur céramique, pomme de douche, douchette et flexible

Incluye
Includes
Inclus



Ref.	€	📦
60328	386,00	1



Códigos Aenor. Disponible a partir de Mayo 2018
Aenor codes. Available from May 2018
Codes Aenor. Disponible à partir de Mai 2018



98027 98776

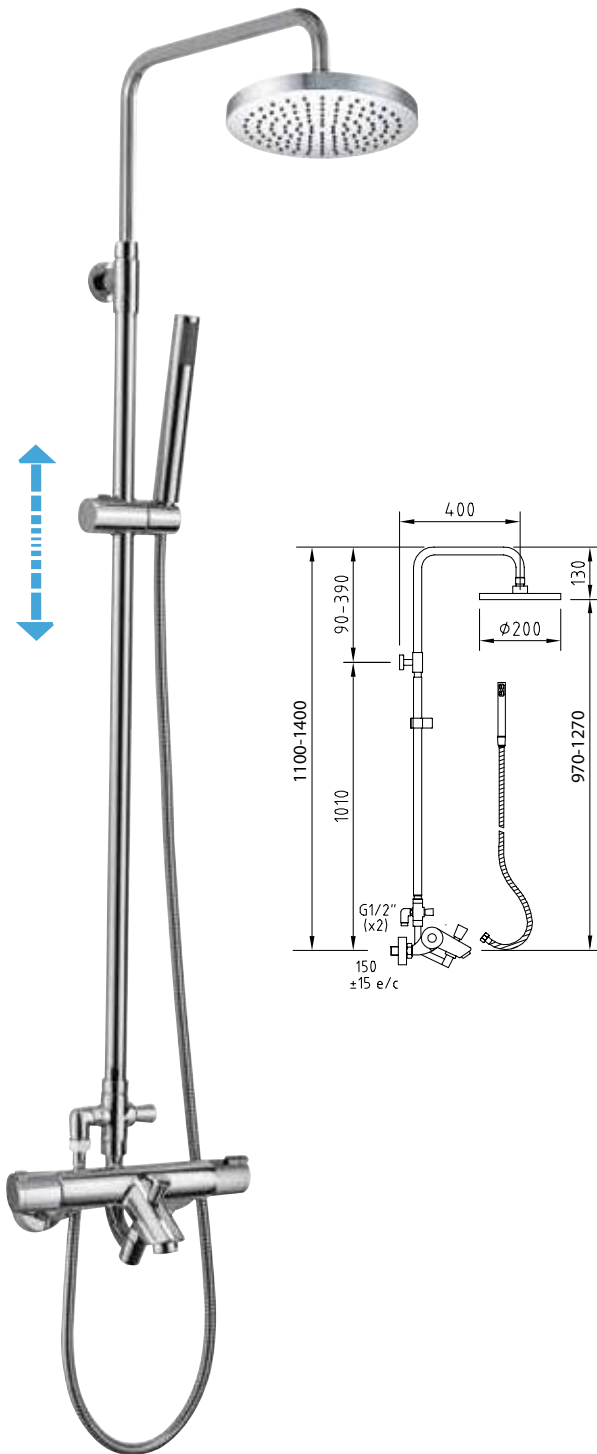

CONJUNTO DE BAÑO-DUCHA TERMOSTÁTICO
Thermostatic bath-shower system
Colonne thermostatique bain-douche extensible

Mezclador termostático de baño-ducha con tubo extensible (98517), soporte articulado deslizante. Adjustable thermostatic bath-shower system (98517) with articulated and sliding holder. Support douchette coulissant, inverseur automatique, pomme de douche, douchette et flexible

Incluye
Includes
Inclus



Ref.	€	📦
98640	450,00	4



Productos relacionados
Related products
Produits connexes



PAG. 148

SILVER HOSE _ 98880
 Flexible. Acabado en plata
 Flexible. Silver finish
 Flexible. Finition argent



PAG. 148

FLEXIBLE _ 97114
 Cromado
 Chrome plated
 Chromé



PAG. 144

CITY AIR _ 99615
 Teléfono ducha ø 100mm
 Handset
 Douchette



PAG. 139

CITY _ 99607
 Rociador ø 225mm
 Shower head
 Pomme de douche



Accesorios de baño

Bath accessories / Accessoires de salle de bain



PLATINUM
112



elegance
114



xtreme
116



urban
118

Ventu **Accesorios de baño** Bathroom accessories | Accessoires de salle de bain

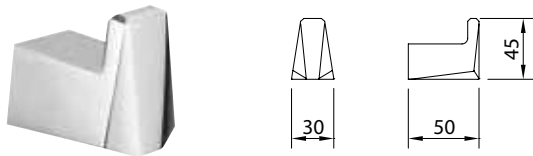

PERCHA VENTU *Clothes hook | Patère*

Latón cromado. Kit fijación incluido.
Brass chromed. Fixing set included.
Laiton chromé. Kit de fixation inclus.

Ref.	€	📦
99470	18,00	30



JABONERA VENTU *Soap Dish | Porte-savon*

Jabonera de pared de cristal glaseada. Kit fijación incluido.
Wall mounted frosted glass soap dish. Fixing set included.
Porte-savon mural en verre. Kit de fixation inclus.

Ref.	€	📦
99471	46,00	10



JABONERA VENTU *Soap Dish | Porte-savon*

Jabonera de pared. Kit fijación incluido.
Wall mounted soap dish. Fixing set included.
Porte-savon mural. Kit de fixation inclus.

Ref.	€	📦
99472	62,00	10



PORTAVASOS VENTU *Brush holder | Porte-verre*

Latón cromado. Kit fijación incluido.
Brass chromed. Fixing set included.
Laiton chromé. Kit de fixation inclus.

Ref.	€	📦
99473	44,00	10



TOALLERO VENTU *Towel rail | Porte-serviette*

Latón cromado. Kit fijación incluido.
Brass chromed. Fixing set included.
Laiton chromé. Kit de fixation inclus.

Ref.	€	📦
99474	41,00	10



PORTARROLLO VENTU *Toilet roll | Porte-rouleau*

Latón cromado. Kit fijación incluido.
Brass chromed. Fixing set included.
Laiton chromé. Kit de fixation inclus.

Ref.	€	📦
99475	52,00	10



PORTARROLLO SIN TAPA VENTU
Tissue holder without cover | Porte-rouleau sans couvercle

Latón cromado. Kit fijación incluido.
 Brass chromed. Fixing set included.
 Laiton chromé. Kit de fixation inclus.

Ref.	€	📦
99476	38,00	10



TOALLERO VENTU
Towel rail | Porte-serviette

Latón cromado. Kit fijación incluido.
 Brass chromed. Fixing set included.
 Laiton chromé. Kit de fixation inclus.

	Ref.	€	📦
40cm	60156	73,00	12
63cm	99477	78,00	10



TOALLERO DOBLE VENTU
Double towel rail | Porte-serviette double-barre

Latón cromado. Kit fijación incluido.
 Brass chromed. Fixing set included.
 Laiton chromé. Kit de fixation inclus.

Ref.	€	📦
99478	98,00	10



PORTATOALLAS VENTU
Towel rack | Porte-serviettes

Latón cromado. Kit fijación incluido.
 Brass chromed. Fixing set included.
 Laiton chromé. Kit de fixation inclus.

Ref.	€	📦
99479	160,00	4

NEW

ESCOBILLERO PARED VENTU
Toilet brush holder | Porte balai wc mural

Cristal gaseado. Latón cromado. Kit fijación incluido.
 Frosted glass. Brass chromed. Fixing set included.
 Cristal glacé. Laiton chromé. Kit de fixation inclus.



Ref.	€	📦
60563	94,00	-

Disponible a partir de Marzo 2018
 Available from March 2018 | Disponible à partir de Mars 2018

Productos relacionados
 Related products
 Produits connexes



PAG. 22

VENTU _ 99428
 Lavabo 85
 Basin mixer 85
 Mitigeur lavabo 85

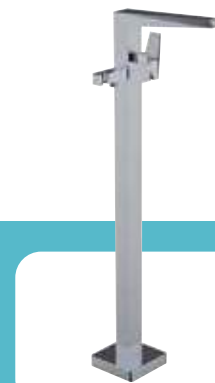

PAG. 23

VENTU _ 99439
 Baño ducha fijación suelo
 Floor standing bath-shower mixer
 Mitigeur bain-douche sur colonne avec prise d'eau au sol

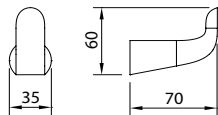

PERCHA
Clothes hook | Patère

Latón cromado. Kit fijación incluido.
Brass chromed. Fixing set included.
Laiton chromé. Kit de fixation inclus.

Ref.	€	📦
99451	19,00	30

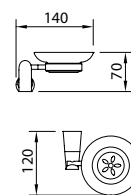

JABONERA
Soap Dish | Porte-savon

Jabonera de pared de cristal glaseada. Kit fijación incluido.
Wall mounted frosted glass soap dish. Fixing set included.
Porte-savon mural en verre. Kit de fixation inclus.

Ref.	€	📦
99452	32,00	10

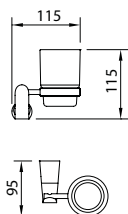

PORTAVASOS
Brush holder | Porte-verre

Latón cromado. Kit fijación incluido.
Brass chromed. Fixing set included.
Laiton chromé. Kit de fixation inclus.

Ref.	€	📦
99453	33,00	10

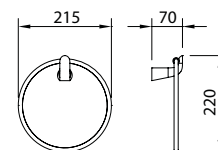

TOALLERO DE ANILLA
Towel ring | Porte-serviette anneau

Latón cromado. Kit fijación incluido.
Brass chromed. Fixing set included.
Laiton chromé. Kit de fixation inclus.

Ref.	€	📦
99454	36,00	10

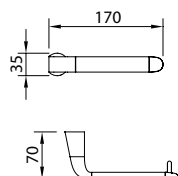

PORTARROLLO SIN TAPA
Tissue holder without cover | Porte-rouleau sans couvercle

Latón cromado. Kit fijación incluido.
Brass chromed. Fixing set included.
Laiton chromé. Kit de fixation inclus.

Ref.	€	📦
99455	33,00	10





TOALLERO
Towel rail | Porte-serviette

Latón cromado. Kit fijación incluido.
Brass chromed. Fixing set included.
Laiton chromé. Kit de fixation inclus.

	Ref.	€	📦
40 cm	60157	48,00	12
62,5 cm	99456	63,00	10



TOALLERO DOBLE
Double towel rail | Porte-serviette double-barre

Latón cromado. Kit fijación incluido.
Brass chromed. Fixing set included.
Laiton chromé. Kit de fixation inclus.

	Ref.	€	📦
	99457	90,00	10



PORTATOALLAS
Towel rack | Porte-serviettes

Latón cromado. Kit fijación incluido.
Brass chromed. Fixing set included.
Laiton chromé. Kit de fixation inclus.

	Ref.	€	📦
	99458	160,00	4

NEW

ESCOBILLERO
Toilet brush holder | Porte balai wc mural

Cerámico. Latón cromado. Kit fijación incluido.
Ceramic. Brass chromed. Fixing set included
Céramique. Laiton chromé. Kit de fixation inclus.



	Ref.	€	📦
	60564	48,00	-

Disponible a partir de Marzo 2018
Available from March 2018 | Disponible à partir de Mars 2018

Productos relacionados
Related products
Produits connexes



PAG. 48

AGORA elegance _ 98680
Lavabo 95
Basin mixer 95
Mitigeur lavabo 95



PAG. 78

START elegance _ 60170
Lavabo 65
Basin mixer 65
Mitigeur lavabo 65



PAG. 237

VELA _ 97395_96255
Válvula desagüe metálico
Drain quick-clac metallic
Vidage métallique



PAG. 43

NINE elegance 60154
Ducha termostática
Thermostatic shower mixer
Mitigeur douche thermostatique

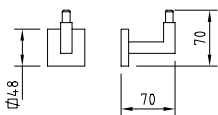

PERCHA Clothes hook | Patère

Latón cromado. Kit fijación incluido.
Brass chromed. Fixing set included.
Laiton chromé. Kit de fixation inclus.

Ref.	€	📦
98655	24,00	30

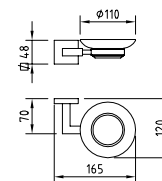

JABONERA Soap Dish | Porte-savon

Jabonera de pared de cristal glaseada. Kit fijación incluido.
Wall mounted frosted glass soap dish. Fixing set included.
Porte-savon mural de cristal glacé. Kit de fixation inclus.

Ref.	€	📦
98824	32,00	10

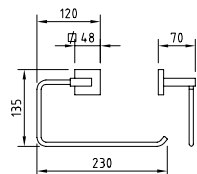

TOALLERO DE ANILLA Towel ring | Porte-serviette anneau

Latón cromado. Kit fijación incluido.
Brass chromed. Fixing set included.
Laiton chromé. Kit de fixation inclus.

Ref.	€	📦
98656	35,00	10

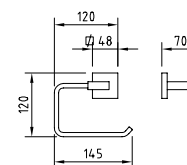

PORTARROLLO Toilet roll | Porte-rouleau

Latón cromado. Kit fijación incluido.
Brass chromed. Fixing set included.
Laiton chromé. Kit de fixation inclus.

Ref.	€	📦
98657	33,00	10



TOALLERO Towel rail | Porte-serviette

Latón cromado. Kit fijación incluido.
Brass chromed. Fixing set included.
Laiton chromé. Kit de fixation inclus.

	Ref.	€	📦
40 cm	60158	42,00	12
56 cm	98658	51,00	10

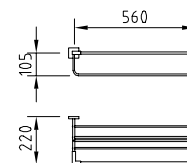
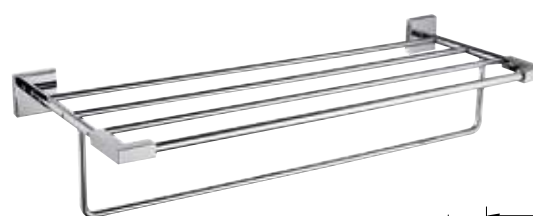

PORTATOALLAS Towel shelf | Porte-serviette

Latón cromado. Kit fijación incluido.
Brass chromed. Fixing set included.
Laiton chromé. Kit de fixation inclus.

Ref.	€	📦
98659	124,00	4

NEW



ESCOBILLERO
Toilet brush holder | Porte balai wc mural

Cristal glaseado. Latón cromado. Kit fijación incluido.
 Frosted glass. Brass chromed. Fixing set included.
 Cristal glacé. Laiton chromé. Kit de fixation inclus.

Ref.	€	
60565	42,00	-

Disponible a partir de Marzo 2018
 Available from March 2018 | Disponible à partir de Mars 2018



Productos relacionados
 Related products
 Produits connexes



PAG. 34

MARINA EVO _ 99413
 Lavabo 110
 Basin mixer 110
 Mitigeur lavabo 110



PAG. 36

SAONA SLIM _ 60115
 Lavabo 115
 Basin mixer 115
 Mitigeur lavabo 115



PAG. 237

HYDRA _ 98675
 Válvula desagüe Universal
 Universal drain quick-clac
 Vidage Universel



PAG. 45

NINE Xtreme _ 60133
 Ducha termostática
 Universal drain quick-clac
 Mitigeur douche thermostatique

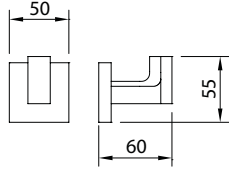

PERCHA
Clothes hook | Patère

Latón cromado. Kit fijación incluido.
Brass chromed. Fixing set included.
Laiton chromé. Kit de fixation inclus.

Ref.	€	📦
99459	22,00	30

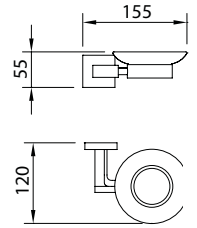

JABONERA
Soap Dish | Porte-savon

Jabonera de pared de cristal gaseada. Kit fijación incluido.
Wall mounted frosted glass soap dish. Fixing set included.
Porte-savon mural en verre. Kit de fixation inclus.

Ref.	€	📦
99460	33,00	10

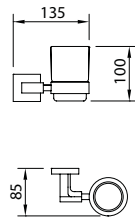

PORTAVASOS
Brush holder | Porte-verre

Latón cromado. Kit fijación incluido.
Brass chromed. Fixing set included.
Laiton chromé. Kit de fixation inclus.

Ref.	€	📦
99461	32,00	10

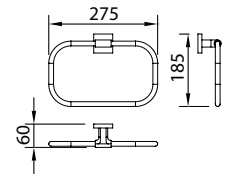

TOALLERO DE ANILLA
Towel ring | Porte-serviette anneau

Latón cromado. Kit fijación incluido.
Brass chromed. Fixing set included.
Laiton chromé. Kit de fixation inclus.

Ref.	€	📦
99462	45,00	10

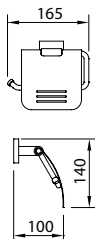

PORTARROLLO
Toilet roll | Porte-rouleau

Latón cromado. Kit fijación incluido.
Brass chromed. Fixing set included.
Laiton chromé. Kit de fixation inclus.

Ref.	€	📦
99463	42,00	10

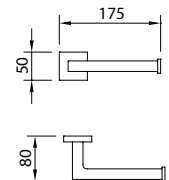

PORTARROLLO SIN TAPA
Tissue holder without cover | Porte-rouleau sans couvercle

Latón cromado. Kit fijación incluido.
Brass chromed. Fixing set included.
Laiton chromé. Kit de fixation inclus.

Ref.	€	📦
99464	31,00	10

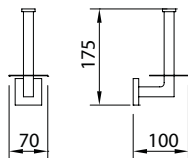

PORTARROLLO
Toilet roll | Porte-rouleau

Latón cromado. Kit fijación incluido.
Brass chromed. Fixing set included.
Laiton chromé. Kit de fixation inclus.

Ref.	€	📦
99465	34,00	10

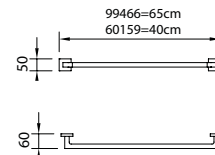

TOALLERO
Towel rail | Porte-serviette

Latón cromado. Kit fijación incluido.
Brass chromed. Fixing set included.
Laiton chromé. Kit de fixation inclus.

	Ref.	€	📦
40 cm	60159	48,00	12
65 cm	99466	53,00	10

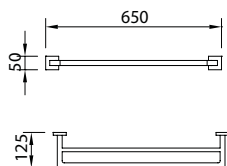

TOALLERO DOBLE
Double towel rail | Porte-serviette double-barre

Latón cromado. Kit fijación incluido.
Brass chromed. Fixing set included.
Laiton chromé. Kit de fixation inclus.

Ref.	€	📦
99467	83,00	10

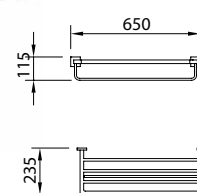

PORTATOALLAS
Towel shelf | Porte-serviette

Latón cromado. Kit fijación incluido.
Brass chromed. Fixing set included.
Laiton chromé. Kit de fixation inclus.

Ref.	€	📦
99468	124,00	4



ESCOBILLERO
Toilet brush holder | Porte balai wc mural

Cerámico. Latón cromado. Kit fijación incluido.
Ceramic. Brass chromed. Fixing set included.
Céramique. Laiton chromé. Kit de fixation inclus.

Ref.	€	📦
60566	66,00	-

Disponible a partir de Marzo 2018
Available from March 2018 | Disponible à partir de Mars 2018

Productos relacionados
Related products
Produits connexes



PAG. 54

ARTIC urban_98102
Lavabo 95
Basin mixer 95
Mitageur lavabo 95



PAG. 105

NINE urban_97676
Ducha termostática
Thermostatic shower mixer
Mitageur douche thermostatique

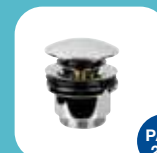

PAG. 237

LEO_98674
Válvula desagüe Universal
Universal drain quick-clac
Vidage Universel

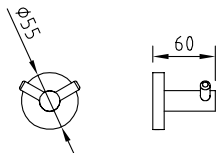

PERCHA Clothes hook | Patère

Latón cromado. Kit fijación incluido.
Brass chromed. Fixing set included.
Laiton chromé. Kit de fixation inclus.

Ref.	€	📦
98650	13,00	30

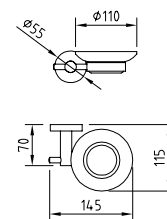

JABONERA Soap Dish | Porte-savon

Jabonera de pared de cristal glaseada. Kit fijación incluido.
Wall mounted frosted glass soap dish. Fixing set included.
Porte-savon mural en verre. Kit de fixation inclus.

Ref.	€	📦
98825	26,00	10

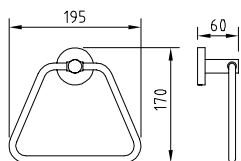

TOALLERO DE ANILLA Towel ring | Porte-serviette anneau

Latón cromado. Kit fijación incluido.
Brass chromed. Fixing set included.
Laiton chromé. Kit de fixation inclus.

Ref.	€	📦
98651	29,00	10

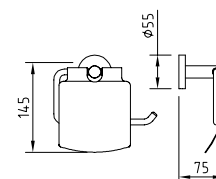

PORTARROLLO Toilet roll | Porte-rouleau

Latón cromado. Kit fijación incluido.
Brass chromed. Fixing set included.
Laiton chromé. Kit de fixation inclus.

Ref.	€	📦
98652	34,00	12

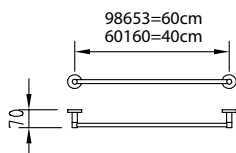

TOALLERO Towel rail | Porte-serviette

Latón cromado. Kit fijación incluido.
Brass chromed. Fixing set included.
Laiton chromé. Kit de fixation inclus.

	Ref.	€	📦
40cm	60160	34,00	12
60cm	98653	37,00	12

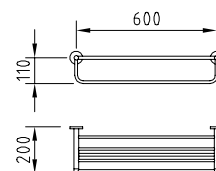

PORTATOALLAS Towel shelf | Porte-serviette

Latón cromado. Kit fijación incluido.
Brass chromed. Fixing set included.
Laiton chromé. Kit de fixation inclus.

Ref.	€	📦
98654	84,00	4

x3
Magnification

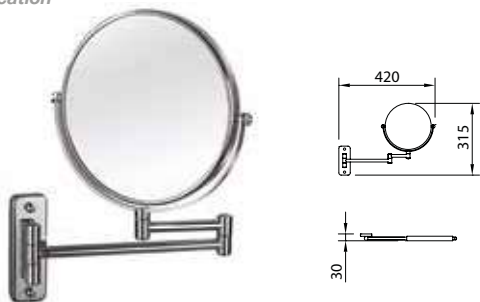

ESPEJO DE AUMENTO PARA LAVABO
Augmented mirror | Miroir grossissant

De doble cara, con visión normal y de 3 aumentos.
Latón cromado. Kit fijación incluido.
Double sided. One side with normal vision and one side with 3 x magnification. Brass chromed. Fixing set included.
Miroir double face avec vision normale et grossissement x 3.
Laiton chromé. Kit de fixation inclus.

Ref.	€	📦
99469	105,00	8

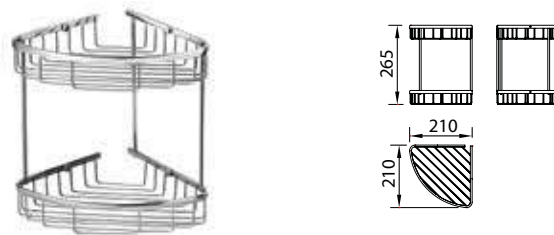

JABONERA DOBLE CROMO
Chromed soap double holder | Etagère d'angle chromée

Latón cromado. Kit fijación incluido.
Brass chromed. Fixing set included.
Laiton chromé. Kit de fixation inclus.

Ref.	€	📦
99480	99,00	8



JABONERA REJILLA CROMO
Chromed soap dish basket | Etagère droite chromée

Latón cromado. Kit fijación incluido.
Brass chromed. Fixing set included.
Laiton chromé. Kit de fixation inclus.

Ref.	€	📦
98826	46,00	10



JABONERA ESQUINA REJILLA CROMO
Chromed corner soap dish basket | Etagère d'angle chromée

Latón cromado. Kit fijación incluido.
Brass chromed. Fixing set included.
Laiton chromé. Kit de fixation inclus.

Ref.	€	📦
98827	42,00	10

Productos relacionados
Related products
Produits connexes



PAG. 64

WITH2 antigua _ 94474
Lavabo 65
Basin mixer 65
Mitigeur lavabo 65



PAG. 237

LEO _ 98674
Válvula desagüe Universal
Universal drain quick-clac
Vidage Universel



PAG. 70

WITH2 morea _ 97012
Baño ducha termostático
Thermostatic bath-shower mixer
Mitigeur bain-douche thermostatique



PAG. 104

NINE SLIM urban _ 60414
Ducha termostática
Thermostatic shower mixer
Mitigeur douche thermostatique

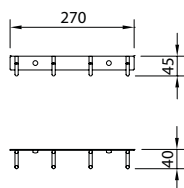

PERCHA 4
Clothes hook | Barre 4 crochets

Acero inoxidable. Kit fijación incluido.
Stainless steel. Fixing set included.
Acier inoxydable. Kit de fixation inclus.

Ref.	€	📦
99481	22,00	30

INOX

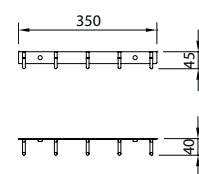

PERCHA 5
Clothes hook | Barre 5 crochets

Acero inoxidable. Kit fijación incluido.
Stainless steel. Fixing set included.
Acier inoxydable. Kit de fixation inclus.

Ref.	€	📦
99482	27,00	30

INOX

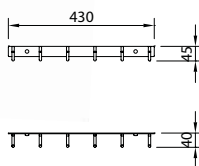

PERCHA 6
Clothes hook | Barre 6 crochets

Acero inoxidable. Kit fijación incluido.
Stainless steel. Fixing set included.
Acier inoxydable. Kit de fixation inclus.

Ref.	€	📦
99483	32,00	30

INOX

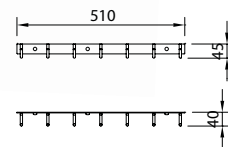

PERCHA 7
Clothes hook | Barre 7 crochets

Acero inoxidable. Kit fijación incluido.
Stainless steel. Fixing set included.
Acier inoxydable. Kit de fixation inclus.

Ref.	€	📦
99484	37,00	30

INOX

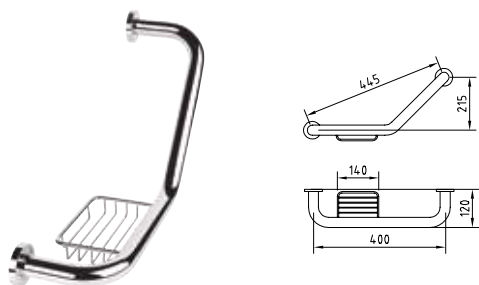

ASA DE SEGURIDAD CURVA CON JABONERA
Brass chrome security curve handle with soap dish
Barre de sécurité avec porte-savon
40cm

Latón cromado. Kit fijación incluido.
 Brass chromed. Fixing set included.
 Laiton chromé. Kit de fixation inclus.

Ref.	€	📦
98895	65,00	2

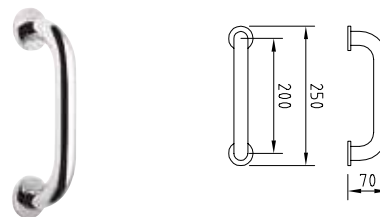

ASA DE SEGURIDAD
Brass chrome security curve handle | Barre de sécurité
20cm

Latón cromado. Kit fijación incluido.
 Brass chromed. Fixing set included.
 Laiton chromé. Kit de fixation inclus.

Ref.	€	📦
98896	43,00	6

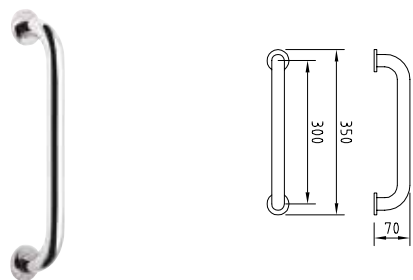

ASA DE SEGURIDAD
Brass chrome security curve handle |
Barre de sécurité

Latón cromado. Kit fijación incluido.
 Brass chromed. Fixing set included.
 Laiton chromé. Kit de fixation inclus.

Ref.	€	📦
98897	48,00	6

NEW



ESCOBILLERO
Toilet brush holder | Porte balai wc mural

Cristal gaseado. Latón cromado. Kit fijación incluido.
 Frosted glass. Brass chromed. Fixing set included.
 Cristal glacé. Laiton chromé. Kit de fixation inclus.

Ref.	€	📦
60567	36,00	-

Disponible a partir de Marzo 2018
Available from March 2018 | Disponible à partir de Mars 2018



HIDROCLEVER



iclever basin
iclever 2
iclever 4
126



Rociadores
Shower heads
Pommes de douche
134



Conjuntos de ducha
Shower kits
Ensembles de douche
140



Brazos rociador
Shower arms
Bras de douche
142



Teléfonos de ducha
Handsets
Douchettes
142

Personaliza tu baño

Customize your bathroom
Personnalisez votre salle de bain



Soportes
Wall brackets
Supports
146



Barras de ducha
Sliding bars
Barres de douche
147



Flexibles
Flexibles
Flexibles
148



Salidas flexo
Wall outlets
Sorties Flexible
148



Caños
Bath spouts
Becs
149



Jets hidromasaje
Body jets
Jets
149

LAVABO EMPOTRADO. Concealed basin mixer | Lavabo encastré

iclever basin



Ref.	€	📦
98703	120,00	6

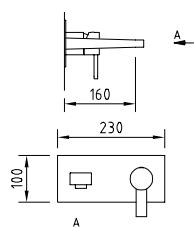
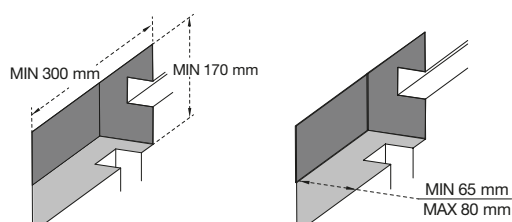

VENTU

99718	209,00	📦 6
-------	--------	-----



99426 98868 98774



BIMINI

98706	136,00	📦 6
-------	--------	-----



95146 98868 98774



PAULA

98708	136,00	📦 6
-------	--------	-----



98215 98868 98774



AGORA elegance

98709	136,00	📦 6
-------	--------	-----



95183 98868 98774



ARTIC xtreme

98710	136,00	📦 6
-------	--------	-----



95185 98868 98774



CAIMAN elegance

98707	136,00	📦 6
-------	--------	-----



95132 98868 98774

* El precio no incluye la caja empotrada / Price does not include the concealed box
Le prix ne comprend pas la boîte d'encastrement



iclever

iClever es el revolucionario sistema de instalación de 1 sola pieza (caja empotrada) que permite obtener todas las funciones de la ducha o baño ducha que desees. Tú eliges las funciones que quieras para tu baño, luego la caja iclever y por último ya puedes escoger el modelo de grifería de nuestra colección que más te guste. En tres simples pasos todos son ventajas!

iClever is the revolutionary 1 piece installation system (concealed box) that allows you to obtain all shower or bath shower functions. You choose the features you want for your bathroom, then the box and finally our iclever , afterwards you are ready to choose the faucet you like. In three simple steps, all the advantages!

iClever est un système révolutionnaire d'installation d'une seule pièce (boîte encastrée) qui permet d'obtenir toutes les fonctions de la douche ou du bain-douche que vous désirez. Vous choisissez les fonctions que vous souhaitez pour votre bain, puis la boîte iClever et enfin vous pouvez choisir le modèle de robinetterie de votre préférence dans notre collection. Trois simples étapes qui ne présentent que des avantages!

Ventajas iclever / iclever advantages / iclever avantages

- ✓ Fácil y rápido de montar y de desmontar.
Easy and quick to assemble and disassemble.
Facile et rapide à monter et à démonter.
- ✓ Evita desperfectos en la superficie cromada de la grifería.
Avoid any damage on the chrome surface.
Évite d'endommager la surface de chrome du robinet.
- ✓ Sistema flexible: con una base se obtienen múltiples configuraciones.
Flexible system: with only a base, we obtain multiple configurations.
Système flexible avec une seule base pour de multiples configurations
- ✓ Gran seguridad y durabilidad.
High level of reliability and durability.
Grande sécurité et durabilité
- ✓ Renueva tu grifería sin obras.
Renew your faucet without works.
Permet de modifier votre robinetterie sans travaux.
- ✓ La instalación permite ser testeada antes del montaje completo.
The installation can be tested before to complete it.
L'installation peut être testée avant l'assemblage complet.

Todas nuestras soluciones

All our solutions

Toutes nos solutions



iclever basin*

Para lavabo empotrado.
For the concealed basin mixer.
Lavabo encastré



iclever 2'

Para ducha empotrada 1 y 2 vías.
For the concealed bath-shower
1 and 2 outlet diverter.
Pour douche encastrée 1 et 2
voies.



iclever 4'

Para ducha empotrada 3 y 4 vías.
Para termostático empotrado 2 y 3 vías.
For the concealed shower 3 and 4 outlet diverter.
For the concealed thermostatic 2 and 3 outlet
diverter.
Pour douche encastrée 3 et 4 voies.
Pour thermostatique encastré 2 et 3 voies.

* El color de la caja puede estar sujeto a modificaciones / The box color may be subject to change / La couleur de la boîte peut être soumise à des changements

DUCHA EMPOTRADA 1 VIA.

Concealed bath-shower 1 outlet diverter | Douche encastré 1 voie

iclever 2



Ref.	€	📦
98711	79,00	6

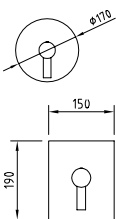
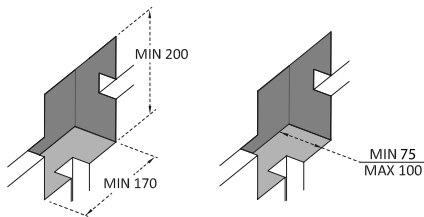

VENTU

99719	130,00	📦 6
-------	--------	-----



BIMINI

98714	95,00	📦 6
-------	-------	-----



PAULA

98716	95,00	📦 6
-------	-------	-----



AGORA *elegance*

98720	95,00	📦 6
-------	-------	-----



ARTIC *xtreme*

98721	95,00	📦 6
-------	-------	-----



* El precio no incluye la caja empotrada / Price does not include the concealed box
Le prix ne comprend pas la boîte d'encastrement



ARTIC urban

98717 95,00 6

ec2 98240 97371



BAHAMA xtreme

98723 95,00 6

98209 90760



CAIMAN elegance

98715 95,00 6

ec2 95132 97371



PANAM xtreme

98726 90,00 6

95172 90760



CAIMAN xtreme

98718 95,00 6

ec2 98212 97371



PANAM urban

98724 90,00 6

95012 90760



CAIMAN urban

98719 95,00 6

ec2 96223 97371



S12 urban

98725 90,00 6

95174 90760

Combinaciones con iclever 2. 1 vía
Combinations iclever 2. 1 outlet diverter / Combinaisons iclever 2. 1 voie



Ducha de empotrar con rociador
Concealed shower with Shower head
Douche encastrée avec pomme de douche



Ducha de empotrar con teléfono
Concealed shower with handset
Douche encastrée avec douchette



Baño de empotrar con caño
Concealed shower with bath spout
Mitigeur bain encastré

DUCHA EMPOTRADA 2 VIAS.

Concealed bath-shower 2 outlet diverter | Douche encastré 2 voies

iclever 2



Ref.	€	📦
98711	79,00	6

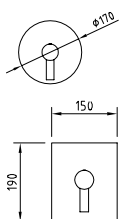
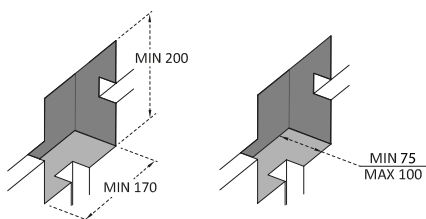

VENTU

99720	151,00	📦 6
-------	--------	-----



BIMINI

98729	120,00	📦 6
-------	--------	-----



PAULA

98731	120,00	📦 6
-------	--------	-----



AGORA *elegance*

98735	120,00	📦 6
-------	--------	-----



ARTIC *xtreme*

98736	120,00	📦 6
-------	--------	-----



* El precio no incluye la caja empotrada / Price does not include the concealed box
Le prix ne comprend pas la boîte d'encastrement



ARTIC urban

98732 120,00 6



98240 97371



BAHAMA xtreme

98738 120,00 6

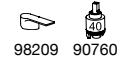

98209 90760



CAIMAN elegance

98730 120,00 6



95132 97371



PANAM xtreme

98741 106,00 6

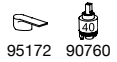

95172 90760



CAIMAN xtreme

98733 120,00 6



98212 97371



PANAM urban

98739 106,00 6



95012 90760



CAIMAN urban

98734 120,00 6



96223 97371



S12 urban

98740 106,00 6



95174 90760

Combinaciones con iclever 2. 2 vías
 Combinations iclever 2. 2 outlet diverter / Combinaisons iclever 2. 2 voies

Ducha / Shower / Douche

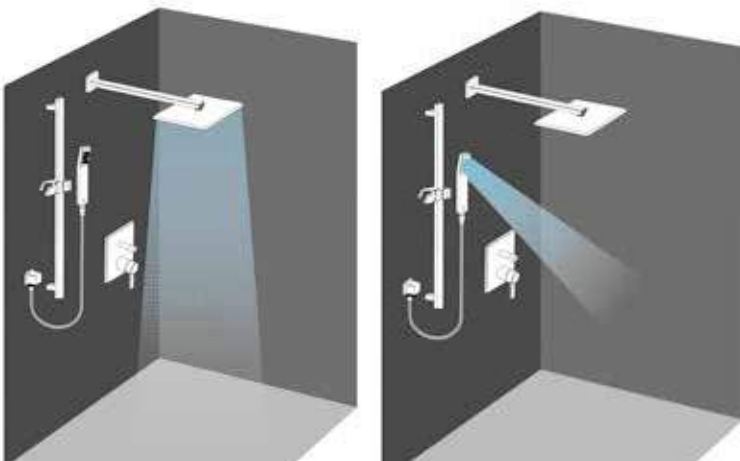

Ducha de empotrar con inversor. Rociador y teléfono.
 Concealed shower with diverter. Shower head and handset.
 Douche encastrée avec inverseur. Pomme de douche et douchette.

Baño - Ducha / Bath-shower / Bain-douche

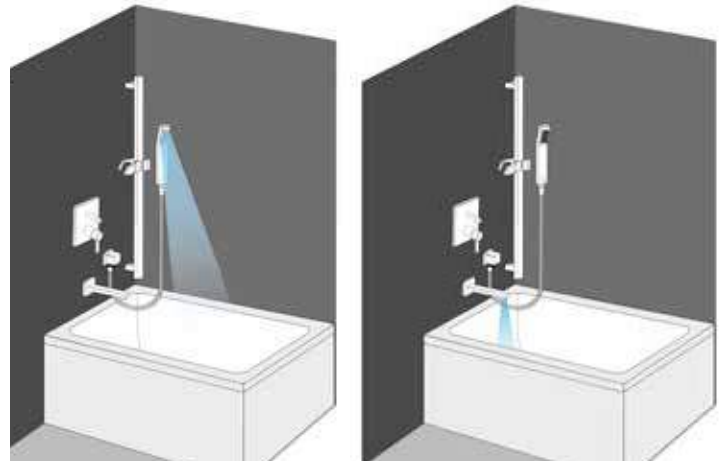

Baño-Ducha de empotrar con inversor. Teléfono y caño.
 Concealed bath-shower with diverter. Handset and spout.
 Bain-Douche encastrée avec inverseur. Pomme de douche ou douchette et bec.

DUCHA EMPOTRADA 3-4 VIAS.

Concealed bath-shower 3-4 outlet diverter | Douche encastré 3-4 voies

iclever 4



Ref.	€	📦
98742	109,00	6

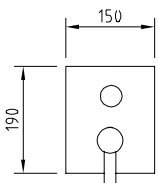
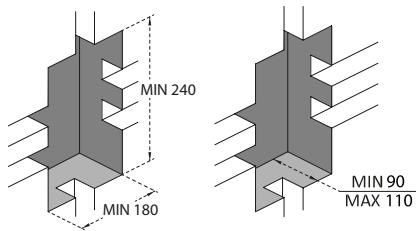

BIMINI

98745	169,00	📦 6
-------	--------	-----



CAIMAN *elegance*

98746	169,00	📦 6
-------	--------	-----



PAULA

98747	169,00	📦 6
-------	--------	-----



AGORA *elegance*

98748	169,00	📦 6
-------	--------	-----



ARTIC *xtreme*

98749	169,00	📦 6
-------	--------	-----



NINE *urban*

98750	219,00	📦 6
-------	--------	-----

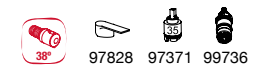

TERMOSTÁTICO / Thermostatic / Thermostatique
MÁX. 3 VIAS / Max. 3 outlet diverter / Max. 3 voies

* El precio no incluye la caja empotrada / Price does not include the concealed box
 Le prix ne comprend pas la boîte d'encastrement

Combinaciones con iclever 4. 3 vías
 Combinations iclever 4. 3 outlet diverter / Combinaisons iclever 4. 3 voies

Ducha / Shower / Douche



Ducha de empotrar con inversor. Rociador, Teléfono o Jets.
 Concealed shower with diverter. Shower head , handset or body jets.
 Douche encastrée avec dérivateur. Pomme de douche, set de douche ou jets.

Baño - Ducha / Bath-shower / Bain-douche

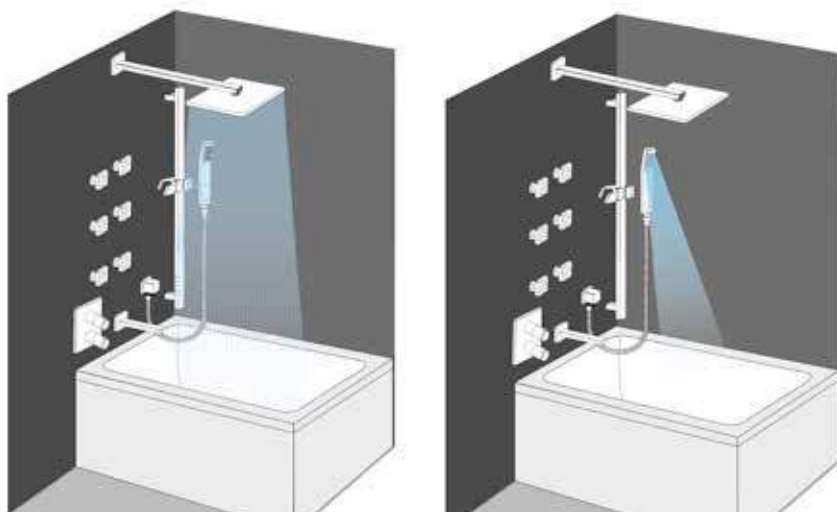

Baño-Ducha de empotrar.
 Rociador, teléfono, jets o caño.
 Concealed bath-shower with diverter.
 Shower head , handset, body jets or bath spout.
 Bain-Douche encastré.
 Pomme de douche, set de douche, jets et bec.

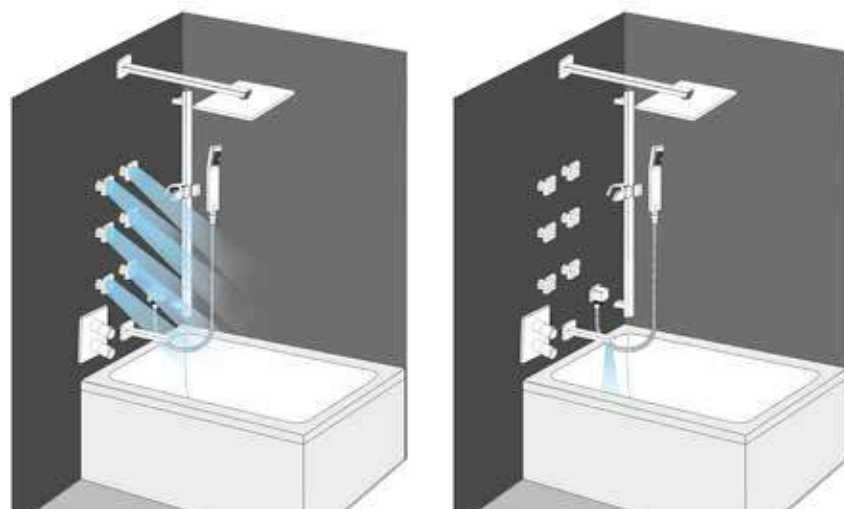

Rociadores

Shower heads
Pommes de douche

Rociador empotrado Angel

*Concealed shower head
Pomme de douche encastrée*



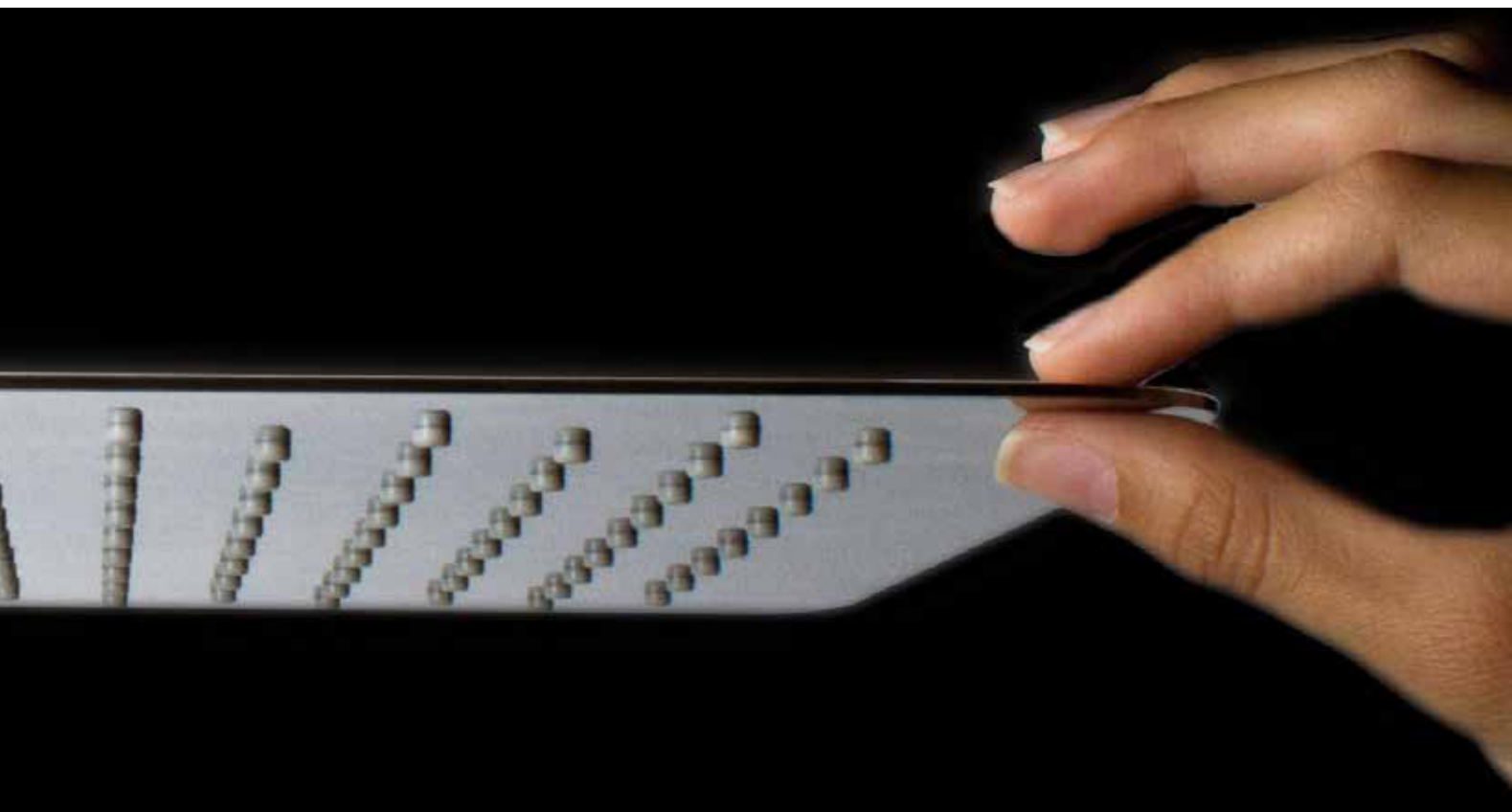
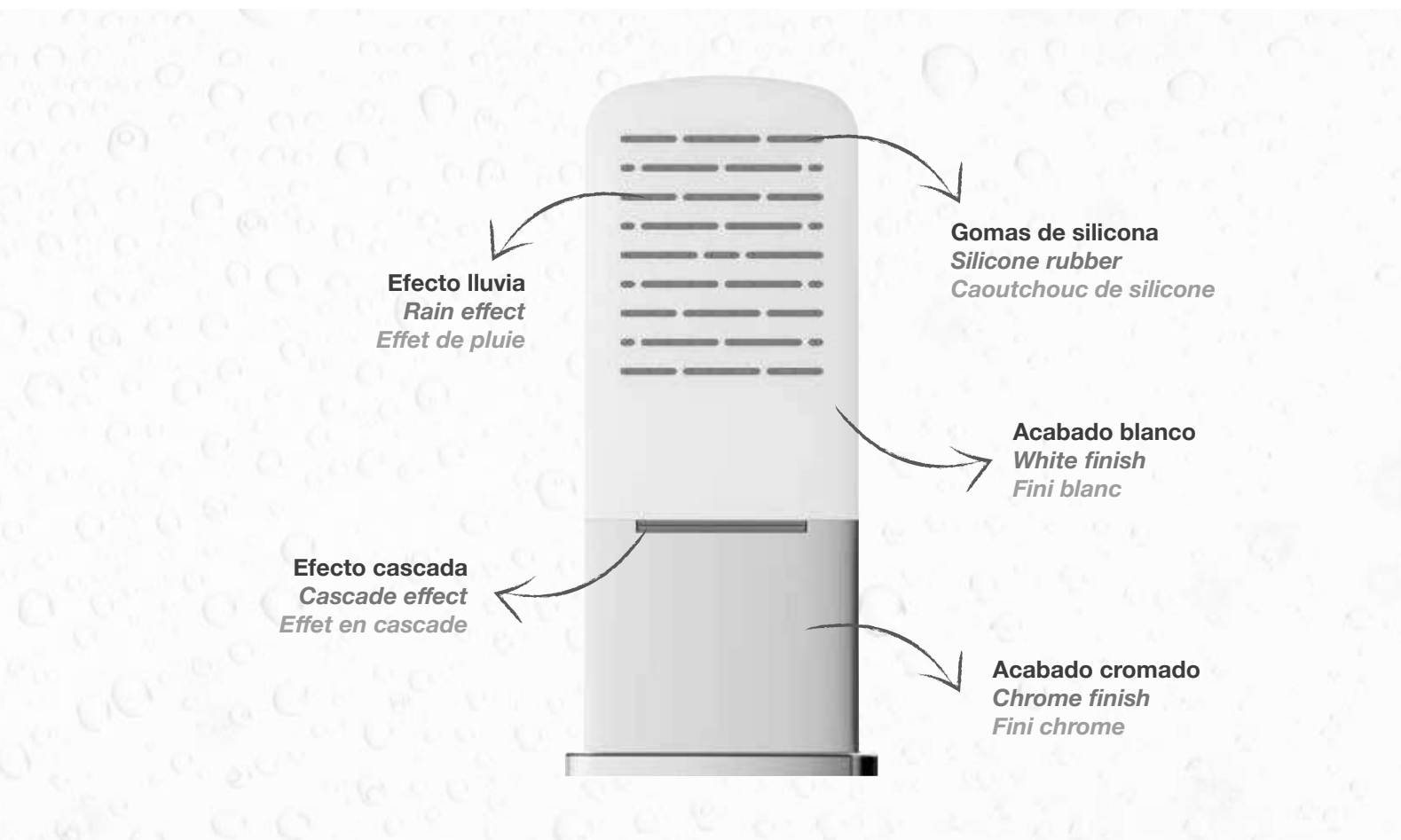

Rociadores

Shower heads
Pommes de douche



AIR Technology / Technologie AIR

Tech AIR

Los rociadores Clever usan la tecnología AIR Advanced. Inyectando aire antes de la salida del agua, se consigue dar volumen a las gotas obteniendo una sensación más suave y confortable en la ducha. También se reduce el consumo de agua hasta un **30%**.

Clever shower heads use the advanced technology AIR Advanced. Mixing air with the incoming water reduces the water consumption at least 30%.

Les pommes de douche Clever sont équipées de la technologie AIR Advanced la plus avancée. L'injection d'air avant la sortie d'eau permet de donner du volume aux gouttes, et d'obtenir une sensation plus douce et confortable sous la douche. Elle permet aussi d'économiser jusqu'à 30% de consommation d'eau et d'énergie.



Water reduce

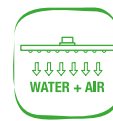

Air Advanced

-30%

Water reduce

SLIM INOX AIR

Rociador a rótula, de acero inoxidable, anticalcáreo.
Stainless steel Shower head, swivel, smart lime cleaning.
Pomme de douche inox, anti calcaire.

1
Función-Function



	Ref.	€	📦
400x400 mm	(INOX) AIR 99688	347,00	5
300x300 mm	(INOX) AIR 99693	161,00	8
250x250 mm	(INOX) AIR 99692	140,00	8
200x200 mm	(INOX) AIR 99600	75,00	12



	Ref.	€	📦
Ø400 mm	(INOX) AIR 99689	306,00	5
Ø300 mm	(INOX) AIR 99691	153,00	8
Ø250 mm	(INOX) AIR 99690	127,00	8
Ø200 mm	(INOX) AIR 99603	68,00	12



	Ref.	€	📦
400x250 mm	(INOX) AIR 99601	217,00	5
300x200 mm	(INOX) AIR 99602	134,00	8



	Ref.	€	📦
Ø400 mm	(INOX) 97276	245,00*	-
SLIM Ø300 mm	(INOX) 98899	98,00*	-

* Hasta agotar existencias

While stocks last / Jusqu'à épuisement des stocks

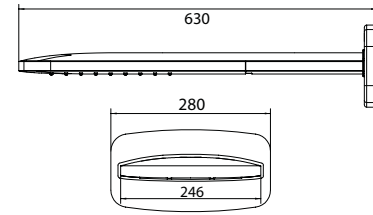

ANGEL
630X245 mm

Rociador empotrado con caída lluvia y cascada. 2 vías
Concealed shower head with rain and waterfall effect. 2 outlet diverter
Pomme de douche encastré avec effet pluie et cascade. 2 voies



Ref.	€	📦
60308	490,00	-

LATÓN Brass - Laiton

Rociador de latón a rótula, anticalcáreo.
Brass Shower head, swivel, smart lime cleaning.
Pomme de douche laiton anti calcaire.

1
Función
Function-Fonction

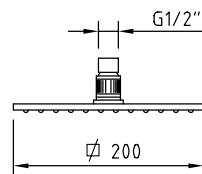

INFINITY
200X200 mm

Ref.	€	📦
99685	160,00	12

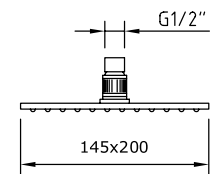

BIMINI
145x200 mm

Ref.	€	📦
99686	152,00	12

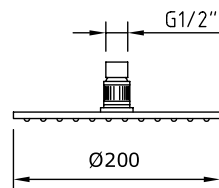

MINAMI
Ø200 mm

Ref.	€	📦
99687	137,00	12

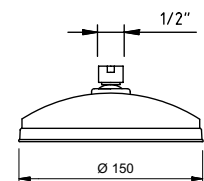

TAMPA
Ø150 mm

Ref.	€	📦
96437	84,00	8

ABS AIR

Rociador de ABS a rótula, anticalcáreo.
ABS Shower head, swivel, smart lime cleaning.
Pomme de douche ABS anti calcaire.

1
Función
Function-Fonction

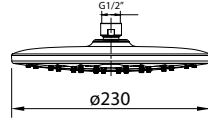

HEXAGON AIR
Ø230 mm

	Ref.	€	
ABS AIR	60306	36,00	-

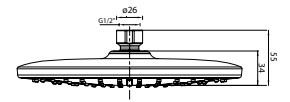

SYVARI EVO AIR
Ø225 mm

	Ref.	€	
ABS AIR	60301	36,00	8

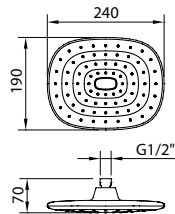

STYLE AIR
240X190 mm

	Ref.	€	
ABS AIR	99606	38,00	32

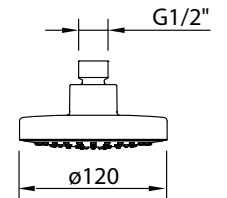

ROUND AIR
Ø120 mm

	Ref.	€	
ABS AIR	99604	24,00	60

ABS

Rociador de ABS a rótula, anticalcáreo.
ABS Shower head, swivel, smart lime cleaning.
Pomme de douche ABS anti calcaire.

1
Función
Function-Fonction

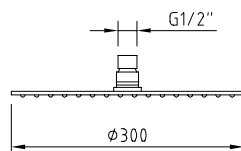

SLIM CIRCULAR
Ø300 mm

	Ref.	€	
ABS	98892	134,00	1

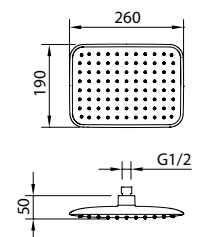

TREND
260x190 mm

	Ref.	€	
ABS	99608	50,00	24

Rociador AutoClean (Autolimpiable)

Autoclean shower head
Pomme de douche autoclean

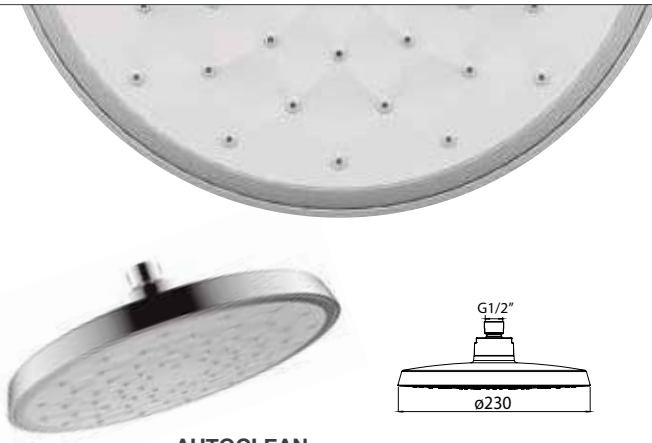

AUTOCLEAN
Ø230 mm

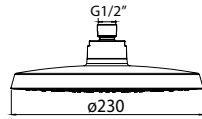

Ref.	€	
ACS ABS 60305	77,00	1



El rociador Auto limpiable evita que se taponen los orificios de salida de agua a través de un sistema interno por agujas.

The shower rain self-cleaning avoids the water outlets to be blocked due to an internal system with needles.

La pomme de douche autonettoyante évite l'entartrage des jets d'eau, grâce à un dispositif intégré qui combine gravité et pression d'eau pour nettoyer les orifices.

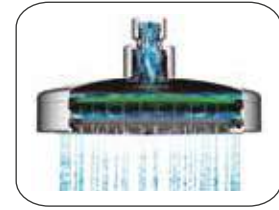

El sistema consigue mantener la trayectoria original de la salida del agua ofreciendo una sensación natural de lluvia.

The system maintains the original water trajectory offering a natural rain sensation.

Ce dispositif permet au jet d'eau de conserver sa trajectoire originale vous offrant une sensation de pluie naturelle en permanence.

BEAM Ø230 mm

Con salida de agua a alta presión vaporizada.

High pressure outlet with spray water sensation.

Avec sortie d'eau à haute pression vaporisée.

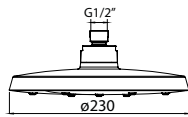

Ref.	€	
ABS BEAM 60303	56,00	-

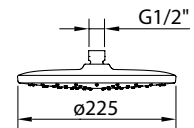

CITY
Ø225 mm

Ref.	€	
ABS 99607	34,00	20

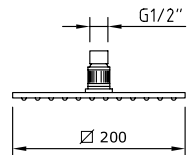

KUBE
200X200 mm

Ref.	€	
ABS 98672	48,00	1

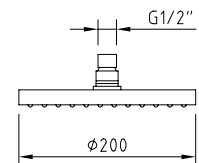

CIRCULAR
Ø200 mm

Ref.	€	
ABS 98518	48,00	16

3
Funciones
Fonctions-Fonctions

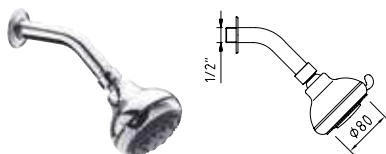

ZANZIBAR
Ø80 mm

Ref.	€	
ABS 96141	25,00	50

Con brazo de ducha
With shower arm | Avec bras de douche

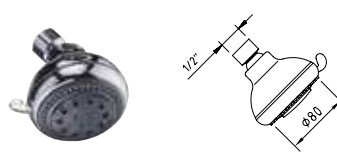

ZANZIBAR
Ø80 mm

Ref.	€	
ABS 96114	16,00	50

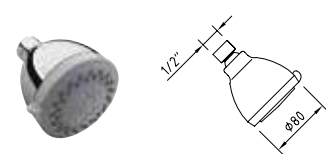

KYOVA
Ø80 mm

Ref.	€	
ABS 97996	15,00	5

Conjuntos ducha Shower kits Ensembles barre de douche

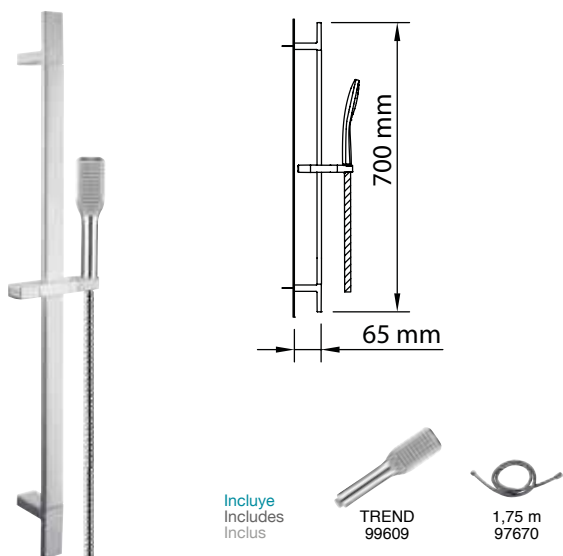

Incluye
Includes
Inclus

TREND
99609

1,75 m
97670

TREND - 30x10x700 mm
CONJUNTO BARRA DUCHA
Sliding bar set | Ensemble barre de douche.
ABS

Ref.	€	📦
99626	85,00	10

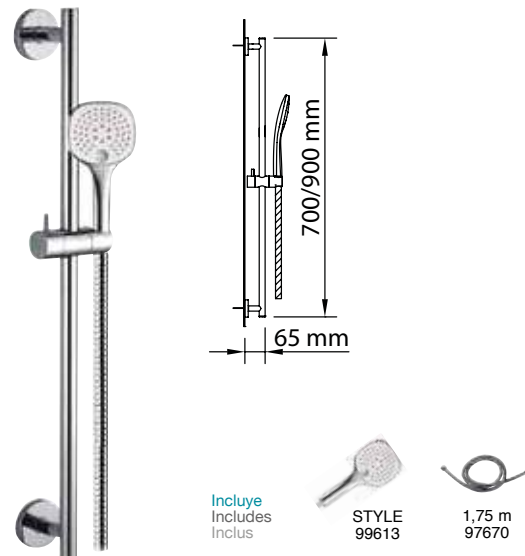

Incluye
Includes
Inclus

STYLE
99613

1,75 m
97670

STYLE
CONJUNTO BARRA DUCHA
Sliding bar set | Ensemble barre de douche.
ABS

Ref.	€	📦
ø19x700 mm 99627	80,00	15
ø19x900 mm 99628	86,00	15



Incluye
Includes
Inclus

CITY AIR
99615

1,75 m
97670

CITY AIR
CONJUNTO BARRA DUCHA
Sliding bar set | Ensemble barre de douche.
ABS

Ref.	€	📦
ø19x700 mm 99624	62,00	15
ø19x900 mm 99625	67,00	15

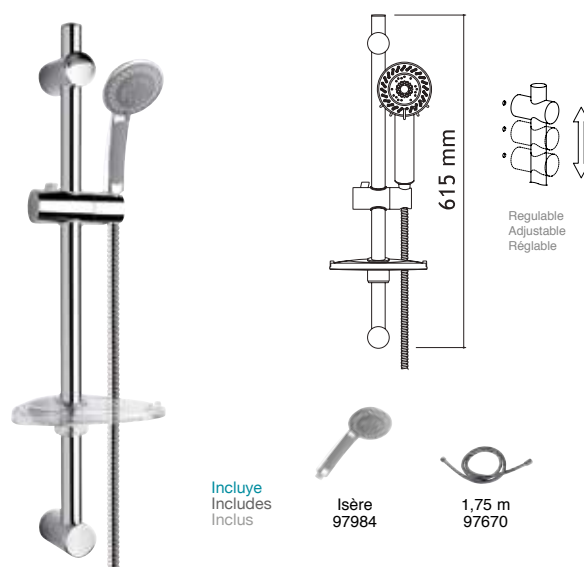

Incluye
Includes
Inclus

Isère
97984

1,75 m
97670

MICHIGAN - Ø25x615 mm
CONJUNTO DUCHA
Sliding bar set | Ensemble barre de douche

Barra de ducha ABS con jabonera extraíble.
ABS Shower kit and adjustable rail with rub clean handset and removable soap dish.
Porte savon amovible. ABS.

Ref.	€	📦
ACS 97988	86,00	2



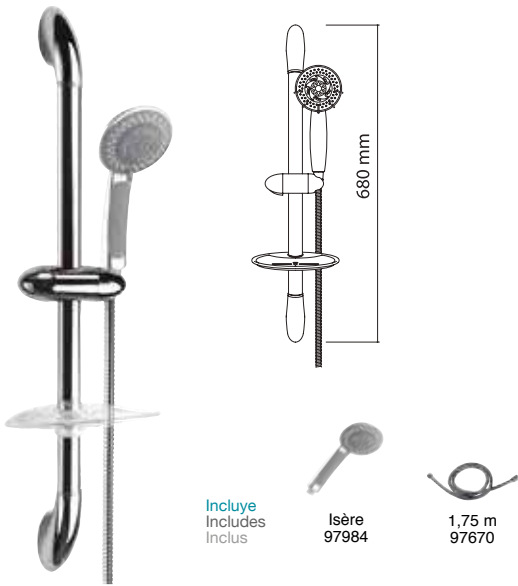

Incluye
Includes
Inclus

Isère
97984

1,75 m
97670

LEMAN - 680 mm
CONJUNTO DUCHA
Sliding bar set | Ensemble barre de douche

Barra de ducha ABS con jabonera extraíble.
ABS Shower kit and adjustable riser rail with rub clean handset and removable soap dish.
Porte savon amovible. ABS.

Ref.	€	
97986	80,00	2

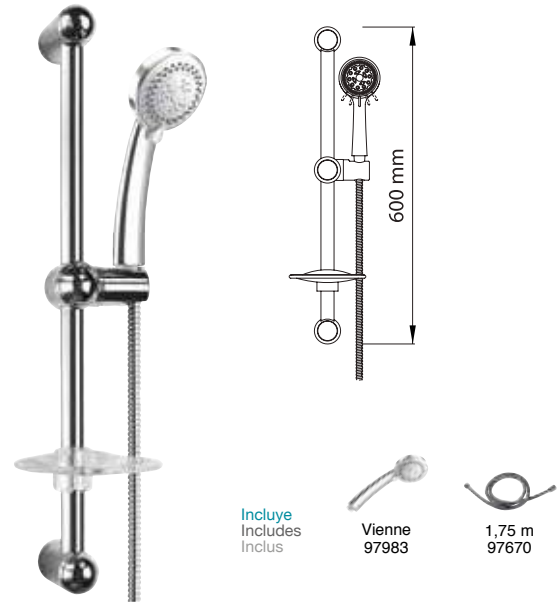

Incluye
Includes
Inclus

Vienne
97983

1,75 m
97670

BAIKAL - Ø25x600 mm
CONJUNTO DUCHA
Sliding bar set | Ensemble barre de douche

Barra de ducha ABS con jabonera extraíble.
ABS Shower kit and adjustable riser rail with rub clean handset and removable soap dish.
Porte savon amovible. ABS.

Ref.	€	
97985	69,00	2

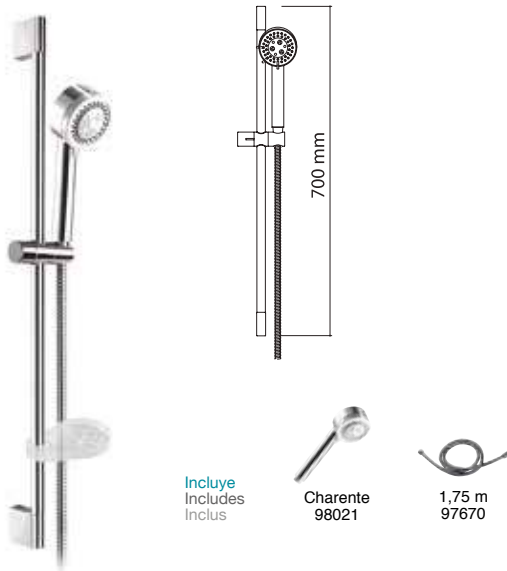

Incluye
Includes
Inclus

Charente
98021

1,75 m
97670

VICTORIA - Ø20x700 mm
CONJUNTO DUCHA
Sliding bar set | Ensemble barre de douche

Barra de ducha ABS con jabonera extraíble.
ABS Shower kit and adjustable rail with rub clean handset and removable soap dish.
Porte savon amovible. ABS.

Ref.	€	
97987	69,00	2



NO EXTENSIBLE NOT EXTENDABLE. NON EXTENSIBILE

Incluye
Includes
Inclus

Circular
98518

Syvari
98884

1,75 m
97670

0,35 m
97396

Support
98998

Kit box
99172

ø20
98997

KIT BOX
CONJUNTO BARRA DUCHA
Shower bar set | Colonne de douche

Ref.	€	
99623	216,00	1



Brazos rociador

Shower arms
Bras de douche

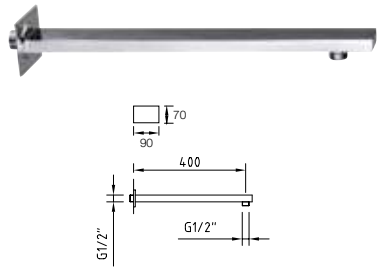

BIMINI
400 mm

Brazo para cabezal de ducha, latón. Pared.
Shower arm, brass. Wall.
Bras pour tête de douche, laiton. Mur.

Ref.	€	📦
98000	64,00	15

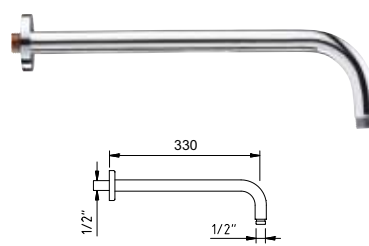

LUZIA
330 mm

Brazo para cabezal de ducha, latón. Pared.
Shower arm, brass. Wall.
Bras pour tête de douche, laiton. Mur.

Ref.	€	📦
96153	40,00	50

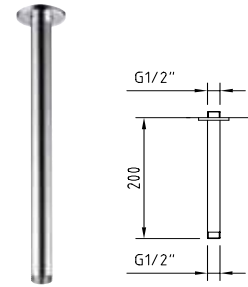

ROOF
200 mm

Brazo para cabezal de ducha, latón. Techo.
Shower arm, brass. Roof.
Bras pour tête de douche, laiton. Toit.

Ref.	€	📦
98005	20,00	20

Teléfono duchas

Handsets
Douchette

ABS

Ducha 5 posiciones, ABS cromado.
Multi-function rub clean handset. Chromed ABS
Douchette 5 positions, ABS chromé.

5
Funciones-
Fonctions



HEXAGON AIR | 5F | Ø100 mm
DUCHA | Handset | Douchette

Ref.	€	📦
60307	17,00	-



TANGANYKA | 5F | Ø100 mm
DUCHA | Handset | Douchette

Ref.	€	📦
ACS 97994	26,00	-



9 l/m, 3 bar



ISÈRE | 5F | Ø100 mm
DUCHA | Handset | Douchette

Ref.	€	📦
ACS 97984	24,00	-



9 l/m, 3 bar



Water reduce



Air Advanced

Tech AIR

Los teléfonos de ducha Clever,

usan la tecnología AIR Advanced. Inyectando aire antes de la salida del agua, se consigue dar volumen a las gotas obteniendo una sensación más suave y confortable en la ducha. También se reduce el consumo de agua hasta un **30%**.

Clever handsets use the advanced technology AIR Advanced. Mixing air with the incoming water reduces the water consumption at least 30%.

Les douchettes Clever sont équipées de la technologie AIR Advanced la plus avancée. L'injection d'air avant la sortie d'eau permet de donner du volume aux gouttes, et d'obtenir une sensation plus douce et confortable sous la douche. Elle permet aussi d'économiser jusqu'à 30% de consommation d'eau et d'énergie.

AIR Technology
Technologie AIR



-30%
Water reduce

ABS

Ducha 3 posiciones, ABS cromado.
Multi-function rub clean handset. Chromed ABS
Douchette 3 positions, ABS chromé.

3
Funciones-
Fonctions



BEAM

Con salida de agua a alta presión vaporizada.

High pressure outlet with spray water sensation.

Avec sortie d'eau à haute pression vaporisée.

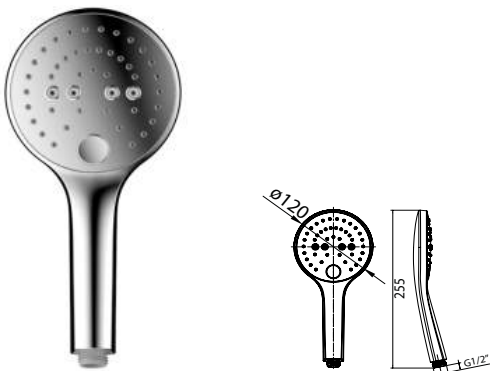

BEAM | 3F | Ø120 mm
DUCHA | Handset | Douchette

Ref.	€	📦
BEAM 60304	32,00	-



9 l/m, 3 bar



STYLE | 3F | 100x120 mm
DUCHA | Handset | Douchette

Ref.	€	📦
99610	30,00	48



STYLE | 3F | 120x120 mm
DUCHA | Handset | Douchette

Ref.	€	📦
99613	26,00	60



9 l/m, 3 bar

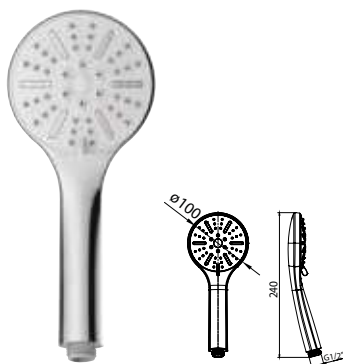

SYVARI EVO AIR | 3F | Ø100 mm
DUCHA | Handset | Douchette

Ref.	€	📦
60302	17,00	-



CITY AIR | 3F | Ø100 mm
DUCHA | Handset | Douchette

Ref.	€	📦
99615	16,00	60



9 l/m, 3 bar



SYVARI | 3F | Ø100 mm
DUCHA | Handset | Douchette

Ref.	€	📦
98884	17,00	1



SYSMA | 3F | Ø90 mm
DUCHA | Handset | Douchette

Ref.	€	📦
98888	25,00	1



VIENNE | 3F | Ø80 mm
DUCHA | Handset | Douchette

Ref.	€	📦
97983	20,00	8



 **Efecto Lluvia**
Rain Spray
Effet pluie



 **Efecto Mousse**
Mousse Spray
Effet mousse



 **Efecto Spray**
Jet Spray
Effet spray



 **Efecto Masaje**
Massage Spray
Effet massage

ABS

Ducha 1 posición, ABS cromado.
Single-function rub clean handset. Chromed ABS
Douchette 1 position, ABS chromé.

1

Función-Function

hidroclever



STYLE AIR | 1F | 100x120 mm
DUCHA | Handset | Douchette

Ref.	€	📦
99611	17,00	60

9 l/m, 3 bar



STYLE AIR | 1F | 120x120 mm
DUCHA | Handset | Douchette

Ref.	€	📦
99612	23,00	60

9 l/m, 3 bar



TREND | 1F | 55x100 mm
DUCHA | Handset | Douchette

Ref.	€	📦
99609	15,00	100

9 l/m, 3 bar



CITY AIR | 1F | Ø100 mm
DUCHA | Handset | Douchette

Ref.	€	📦
99614	15,00	60

9 l/m, 3 bar



NF | 1F | Ø80 mm
DUCHA | Handset | Douchette

Ref.	€	📦
99129	13,00	1

ACS NF



NANKAI | 1F | Ø90 mm
DUCHA | Handset | Douchette

Ref.	€	📦
97142	15,00	50

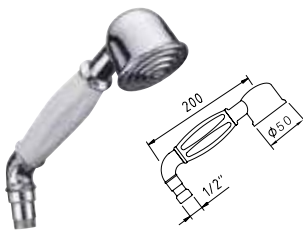

ANTIGONA | 1F | Ø50 mm
DUCHA | Handset | Douchette

Ref.	€	📦
90758	18,00	50

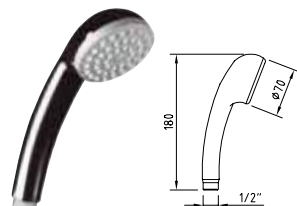

S12 | 1F | Ø70 mm
DUCHA | Handset | Douchette

Ref.	€	📦
98342	7,75	1

ACS

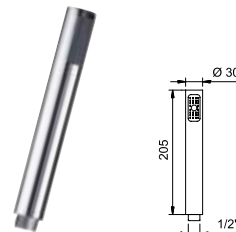

CAIMAN | 1F
DUCHA | Handset | Douchette

Ref.	€	📦
90796	12,00	50

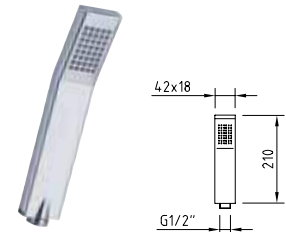

MARINA | 1F
DUCHA | Handset | Douchette

Ref.	€	📦
96786	21,00	50

Latón / Brass / Laiton

Soportes

Wall brackets
Supports de douchette

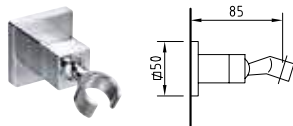

PASCUA
SOPORTE ARTICULADO
Articulated holder
Support douchette orientable

Latón cromado.
Chromed brass.
Laiton chromé.

Ref.	€	📦
97112	27,00	20

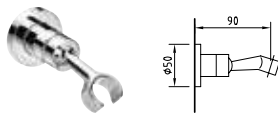

TONGA
SOPORTE ARTICULADO
Articulated holder
Support douchette orientable

Latón cromado.
Chromed brass.
Laiton chromé.

Ref.	€	📦
97113	18,00	20



LUZON
SOPORTE ARTICULADO
Articulated holder
Support douchette orientable

ABS cromado.
Chromed ABS.
ABS chromé.

Ref.	€	📦
96458	11,00	20



MOA
SOPORTE ARTICULADO
Articulated holder
Support douchette orientable

ABS cromado.
Chromed ABS.
ABS chromé.

Ref.	€	📦
96942	7,75	50

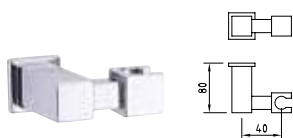

SAONA
SOPORTE ARTICULADO
Articulated holder
Support douchette orientable

ABS cromado.
Chromed ABS.
ABS chromé.

Ref.	€	📦
96413	7,25	20

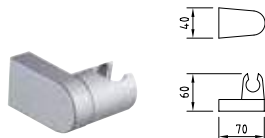

HABANA XTREME
SOPORTE ARTICULADO
Articulated holder
Support douchette orientable

ABS cromado.
Chromed ABS.
ABS chromé.

Ref.	€	📦
98208	5,50	20

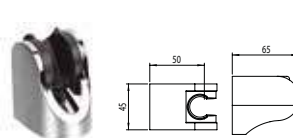

START
SOPORTE ARTICULADO
Articulated holder
Support douchette orientable

ABS cromado.
Chromed ABS.
ABS chromé..

Ref.	€	📦
60311	5,00	-

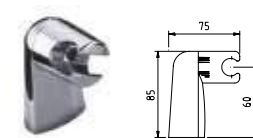

MADAGASCAR
SOPORTE ARTICULADO
Articulated holder
Support douchette orientable

ABS cromado.
Chromed ABS.
ABS chromé.

Ref.	€	📦
96112	4,30	100

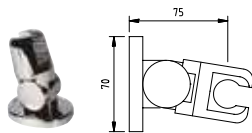

HABANA
SOPORTE ARTICULADO
Articulated holder
Support douchette orientable

ABS cromado.
Chromed ABS.
ABS chromé.

Ref.	€	📦
90011	4,20	20

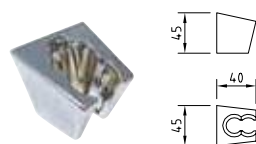

S12
SOPORTE FIJO
Fix holder
Support douchette fixe

ABS cromado, 2 posiciones.
Chromed ABS, 2 positions.
ABS chromé, 2 positions.

Ref.	€	📦
98343	2,40	24

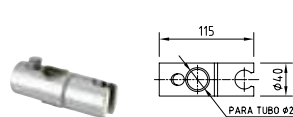

BASIC BOX
SOPORTE DESLIZANTE ARTICULADO
Articulated holder
Support coulissant articulé

Para tubo ø20.
Tube ø20.
Pour tube ø20.

Ref.	€	📦
98997	13,75	20

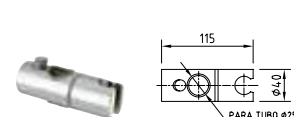

CEILAN
SOPORTE DESLIZANTE ARTICULADO
Articulated holder
Support coulissant articulé

Para tubo ø25.
Tube ø25.
Pour tube ø25.

Ref.	€	📦
96264	20,75	20

Barras de ducha

Sliding bars
Barres de douche

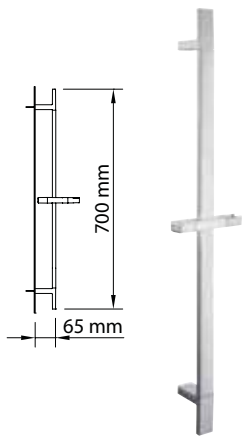

TREND 30x10x700 mm
BARRA DE DUCHA
Sliding bar
Barre de douche

ABS.

Ref.	€	📦
99620	66,00	10

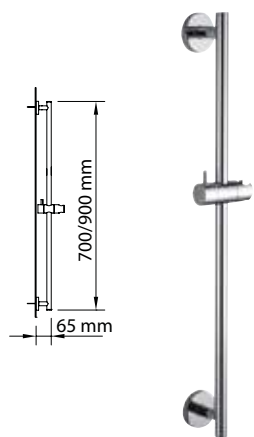

STYLE
BARRA DE DUCHA
Sliding bar
Barre de douche

ABS.

Ref.	€	📦
ø19x700 mm 99621	46,00	15
ø19x900 mm 99622	53,00	15

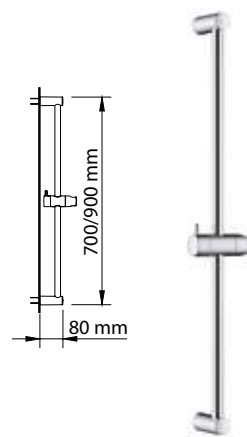

CITY
BARRA DE DUCHA
Sliding bar
Barre de douche

ABS.

Ref.	€	📦
ø19x700 mm 99618	40,00	15
ø19x900 mm 99619	42,00	15

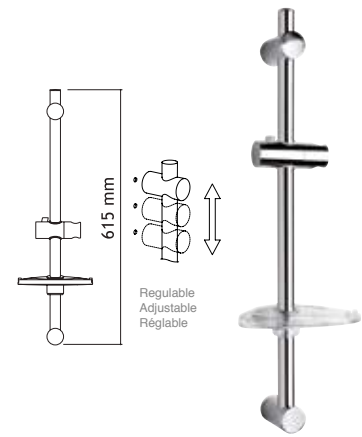

EIRE ø25x615 mm
BARRA DE DUCHA
Sliding bar
Barre de douche

Con jabonera extraíble.
Removable soap dish.
Porte savon amovible.

Ref.	€	📦
97992	57,00	2

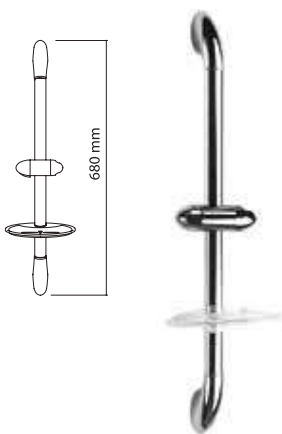

GARDA 680 mm
BARRA DE DUCHA
Sliding bar
Barre de douche

Con jabonera extraíble.
Removable soap dish.
Porte savon amovible.

Ref.	€	📦
97990	53,00	2

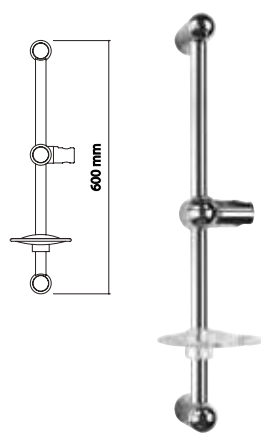

ARAL ø25x600 mm
BARRA DE DUCHA
Sliding bar
Barre de douche

Con jabonera extraíble.
Removable soap dish.
Porte savon amovible.

Ref.	€	📦
97989	46,00	2

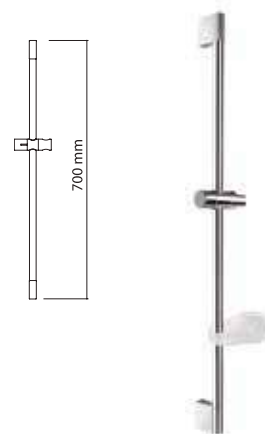

MALAWI ø20x700 mm
BARRA DE DUCHA
Sliding bar
Barre de douche

Con jabonera extraíble.
Removable soap dish.
Porte savon amovible.

Ref.	€	📦
97991	44,00	2

Flexibles Flexibles Flexibles

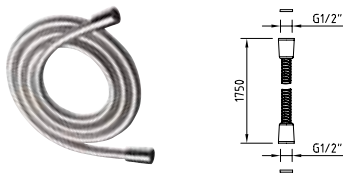

SILVER HOSE
1,75m
FLEXIBLE | Flexible | Flexible

PVC. Acabado en plata.
PVC. Silver finish.
PVC. Finition argent



Ref.	€	📦
98880	22,00	1
98022	35,00	1



FLEXIBLE
Flexible | Flexible
1,75m

Tubo flexible con record 1/2" para ducha teléfono con 2 records cónicos. Latón.
Flexible 1/2" for handshower with 2 conical nuts. Brass.
Ecrous coniques. Laiton.

Ref.	€	📦
96122	14,10	100



FLEXIBLE
Flexible | Flexible

97816: L=1,20 m Inox, stainless steel, inox
90703: L=1,50 m Inox, stainless steel, inox
90704: L=1,75 m Inox, stainless steel, inox
97670: L=1,75 m Inox, stainless steel, inox
97114 cromado: L=1,80 m Inox, stainless steel, inox
99128: L=1,75 m Inox, stainless steel, inox

Ref.	€	📦	Ref.	€	📦
97816	5,80	15	97670	8,75	50
90703	6,40	50	97114	14,70	50
90704	8,30	40	99128	9,50	50

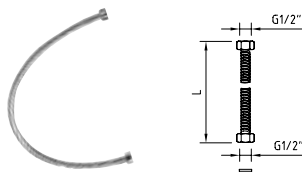

FLEXIBLE
Flexible | Flexible

Tubo flexible con 2 records hexagonales para 99136.
Flexible with 2 hexagonal nuts for 99136.
Ecrous hexagonaux pour 99136.

97396: L=35 cm Inox, stainless steel, inox
97397: L=60 cm Inox, stainless steel, inox

Ref.	€	📦
97396	3,40	24
97397	5,60	50

Salidas flexo Wall outlets Sorties flexible

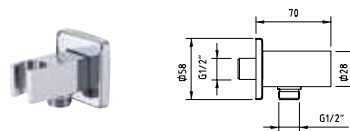

BIMINI

Salida flexo mural con soporte. Latón
Wall hose bib outlet with holder. Brass.
Sortie flexible murale, avec suport. Laiton.

Ref.	€	📦
98235	26,00	20

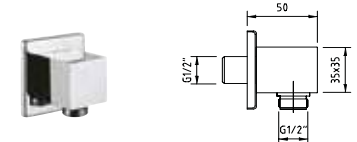

BIMINI

Salida flexo mural. Latón
Wall hose bib outlet. Brass.
Sortie flexible murale. Laiton.

Ref.	€	📦
98001	25,00	20

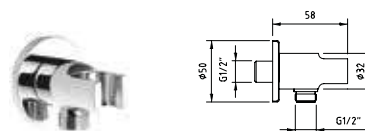

CAIMAN urban

Salida flexo mural con soporte. Latón
Wall hose bib outlet with holder. Brass.
Sortie flexible murale, avec suport. Laiton.

Ref.	€	📦
98236	26,00	10

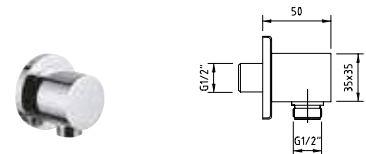

CAIMAN urban

Salida flexo. Latón
Hose bib outlet. Brass.
Sortie flexible. Laiton.

Ref.	€	📦
97148	25,00	10

Caños empotrar

Bath spouts
Becs baignoire



BIMINI 185 mm
CAÑO MURAL
Bath spout | Bec

Caño mural para baño. Latón
Bath wall spout. Brass
Bec murale pour bains. Laiton.



Ref.	€	📦
97999	62,00	20

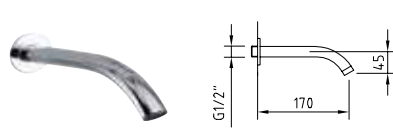

MIKURA 170 mm
CAÑO MURAL
Bath spout | Bec

Caño mural para baño. Latón
Bath wall spout. Brass
Bec murale pour bains. Laiton.



Ref.	€	📦
97368	40,00	10

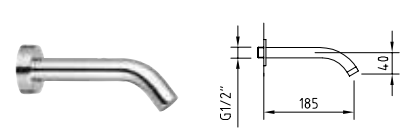

CAIMAN 185 mm
CAÑO MURAL
Bath spout | Bec

Caño mural para baño. Latón
Bath wall spout. Brass
Bec murale pour bains. Laiton.



Ref.	€	📦
98004	34,00	20

Jets hidromasaje

Body jets
Jets

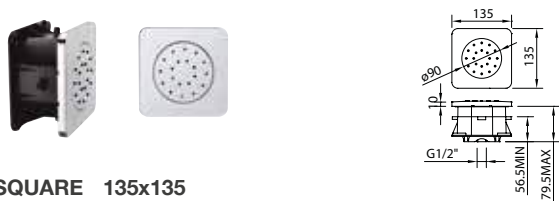

SQUARE 135x135
JET HIDROMASAJE EMPOTRAR
Concealed body jets | Jets encastré

Cuadrado articulado. ABS
Articulated square. ABS
Carré articulé. ABS

Ref.	€	📦
99616	83,00	18



ROUND Ø135
JET HIDROMASAJE EMPOTRAR
Concealed body jets | Jets encastré

Redondo articulado. ABS
Articulated round. ABS
Round articulé. ABS

Ref.	€	📦
99617	83,00	18



SQUARE 48x48, 6 l/m - 3 bar
JET HIDROMASAJE
Body jets | Jets

Cuadrado, 2 piezas. Latón
Square, 2 pieces. Brass
Carré, 2 pièces. Laiton

Ref.	€	📦
98440	100,00	10

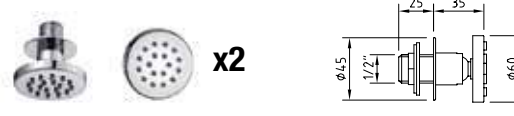

ROUND Ø60, 6 l/m - 3 bar
JET HIDROMASAJE
Body jets | Jets

Redondo, 2 piezas. Latón
Round, 2 pieces. Brass
Round, 2 pièces. Laiton

Ref.	€	📦
98441	100,00	10



GAMA BOX

Clever Box, visual y atractivo

Atractive and visual / Pratique et attrayant



Clever Box Termostático
Thermostatic Clever Box
Clever Box Thermostatique
152



Clever Box Monomando
Single lever Clever Box
Clever Box mitigeur
154



Expositores de sobremesa
Floorstand
Présentoir de comptoir
156

clever box

TERMOSTÁTICO. Visual y atractivo.
 Thermostatic. Attractive and visual
 Thermostatique. Pratique et attrayant

*Este producto se suministra en formato Clever Box
 (Pack indivisible de 4 unidades)

*This product is provided in Clever Box packaging
 (Indivisible packaging of 4 units)*

*Ce produit est conditionné en Clever Box (Pack indivisible
 de 4 unités)*

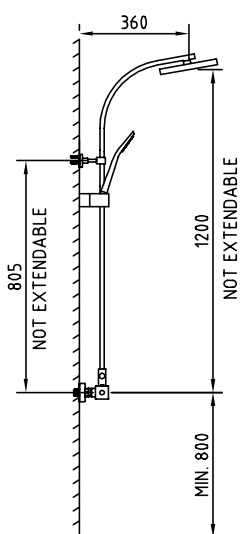
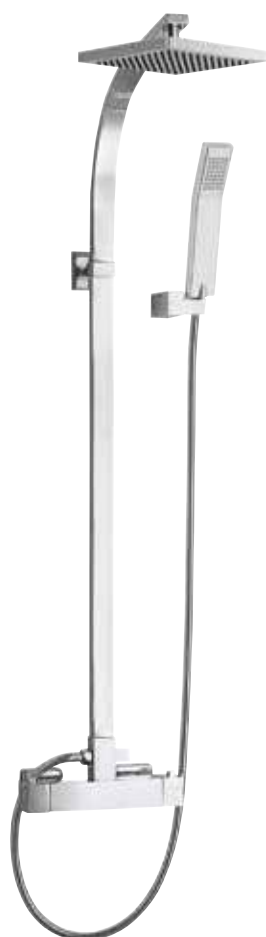

NO EXTENSIBLE
 NOT EXTENDABLE.
 NON EXTENSIBLE

KUADRAT THERM BOX

CONJUNTO DE DUCHA TERMOSTÁTICO

Thermostatic shower system

Colonne thermostatique douche

Mezclador termostático de ducha con inversor automático.
 Thermostatic shower valve with automatic diverter.
 Support douchette orientable, inverseur automatique,
 pomme de douche, douchette et flexible

Incluye
 Includes
 Inclus



Kube
 98672



Marina
 96786



1,75 m
 97670



Saona
 96413

Ref.	€		
98671	575,00	4*	Clever Box 64,5 x 40 x 122 cm



98027



96253

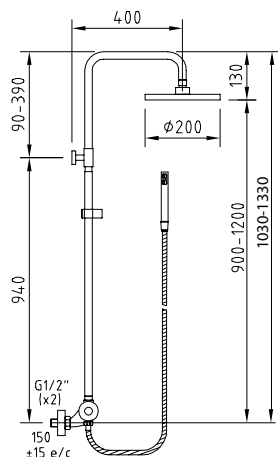

Inversor incorporado en la maneta de caudal
Diverter built in the flow handle
Inverseur intégré dans la poignée

EXTENSIBLE CIRCULAR THERM BOX

CONJUNTO DE DUCHA TERMOSTÁTICO EXTENSIBLE
Adjustable thermostatic shower system | Colonne thermostatique douche extensible

Mezclador termostático de ducha con tubo extensible Circular (98517), soporte articulado deslizante.
Adjustable thermostatic shower valve with diverter built in.
Support douchette coulissant, inverseur céramique, pomme de douche, douchette et flexible

Incluye
Includes
Inclus



Ref.	€	Q	Clever Box 36 x 35 x 92 cm
98762	406,00	4*	
60412	406,00	1	NEW Código Aenor. Disponible a partir de Mayo 2018 Aenor code. Available from May 2018 Code Aenor. Disponible à partir de Mai 2018

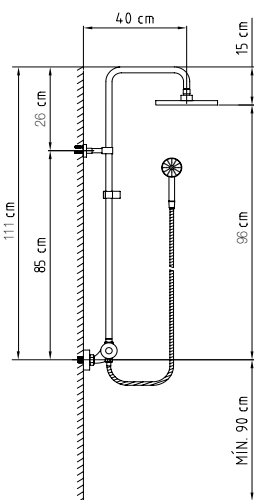

⚠ NO EXTENSIBLE
NOT EXTENDABLE.
NON EXTENSIBLE

Inversor incorporado en la maneta de caudal
Diverter built in the flow handle
Inverseur intégré dans la poignée

CIRCULAR THERM BOX

CONJUNTO DE DUCHA TERMOSTÁTICO
Thermostatic shower system
Colonne thermostatique douche

Mezclador termostático de ducha soporte articulado deslizante.
Thermostatic shower valve with diverter built in.
Support douchette coulissant, inverseur céramique, pomme de douche, douchette et flexible

Incluye
Includes
Inclus



Ref.	€	Q	Clever Box 36 x 35 x 92 cm
98995	376,00	4*	
60413	376,00	1	NEW Código Aenor. Disponible a partir de Mayo 2018 Aenor code. Available from May 2018 Code Aenor. Disponible à partir de Mai 2018



clever box

MONOMANDO. Visual y atractivo.
Single lever. Attractive and visual
Mitigeur. Pratique et attrayant

*Este producto se suministra en formato Clever Box
(Pack indivisible de 4 unidades)

*This product is provided in Clever Box packaging
(Indivisible packaging of 4 units)*

*Ce produit est conditionné en Clever Box (Pack indivisible
de 4 unités)*

Clever Box 97 x 58 x 49,5 cm

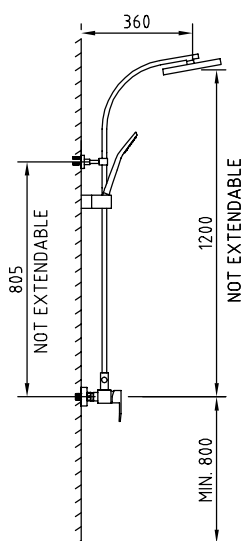

⚠ NO EXTENSIBLE
NOT EXTENSIBLE.
NON EXTENSIBLE

KUADRAT MANUAL BOX

CONJUNTO DE DUCHA Shower system Colonne mitigeur douche

Mezclador de ducha con tubo con inversor automático.
Adjustable shower valve with automatic diverter.
Support douchette orientable, inverseur automatique,
pomme de douche, douchette et flexible

Incluye
Includes
Inclus



Ref.	€	📦
ec1 98850	482,00	4*

Clever Box
64,5 x 40 x 122 cm



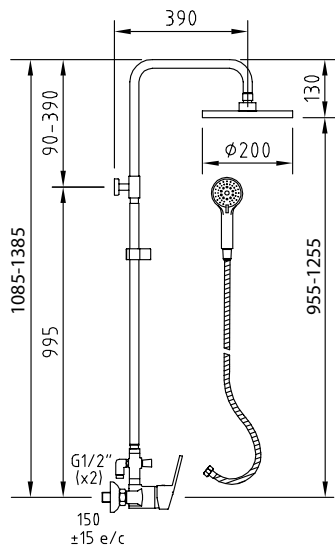

EXTENSIBLE CIRCULAR MANUAL BOX

CONJUNTO DE DUCHA EXTENSIBLE
Adjustable shower system
Colonne mitigeur douche extensible

Mezclador de ducha con tubo extensible Circular (98517), soporte articulado deslizante.
 Adjustable shower valve with automatic diverter.
 Support douchette coulissant, inverseur automatique, pomme de douche, douchette et flexible

Incluye
 Includes
 Inclus



Ref.	€	Q
ec1 98527	309,00	4*

Clever Box
 36 x 35 x 92 cm

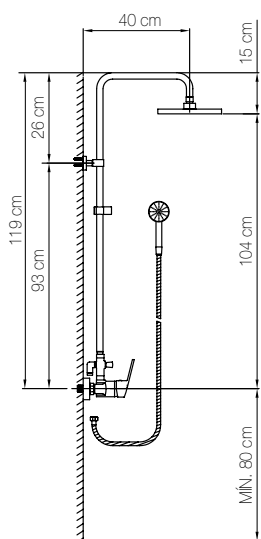
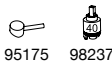

CIRCULAR MANUAL BOX

CONJUNTO DE DUCHA
Shower system
Colonne mitigeur douche

Mezclador de ducha soporte articulado deslizante.
 Adjustable shower valve with automatic diverter.
 Ensemble de douche, pomme de douche supérieure articulée, douchette et flexible.

Incluye
 Includes
 Inclus



Ref.	€	Q
ec1 99142	279,00	4*

Clever Box
 36 x 35 x 92 cm

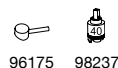

⚠ NO EXTENSIBLE
 NOT EXTENDABLE.
 NON EXTENSIBLE

Sobremesa

Perfectos para el mostrador

Floorstand, perfect for your shop

Présentoir de comptoir, parfait pour votre point de vente



Télefono de ducha SYVARI 3F Ø100mm 98884

Handset SYVARI
Douchette SYVARI

Expositor sobremesa SYVARI Floorstand SYVARI Présentoir de comptoir SYVARI

Ref.	€	📦
98885	16,50	16*

*Pack indivisible de 16 unidades
*(Indivisible Packaging of 16 units)
*(Pack indivisible de 16 unités)



Flexible SilverHose 1,75m 98880

SilverHose Flexible
Flexible SilverHose

Expositor sobremesa SilverHose Floorstand SilverHose Présentoir de comptoir SilverHose

Ref.	€	📦
98881	21,00	10*

*Pack indivisible de 10 unidades
*(Indivisible Packaging of 10 units)
*(Pack indivisible de 10 unités)

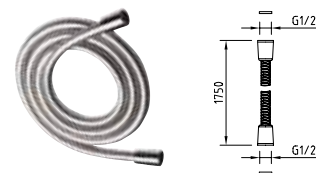

Expositor sobremesa 4 ACCESSORIES BATH BOX

Floorstand 4 Accessories Bath Box
Présentoir de comptoir 4 Accessoires Bath Box

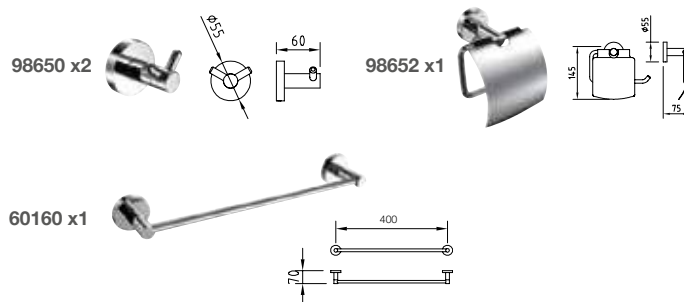

Ref.	€	📦
99450	92,00	8*

*Pack indivisible de 8 unidades
*(Indivisible Packaging of 8 units)
*(Pack indivisible de 8 unités)



NEW

LEO BOX
Pop-up quick-clac metal 1-1/4"
Vidage quick-clac metal 1-1/4"

Ref.	€	📦
60418	13,00	24*

*Pack indivisible de 24 unidades)
 *(Indivisible Packaging of 24 units)
 *(Pack indivisible de 24 unités)

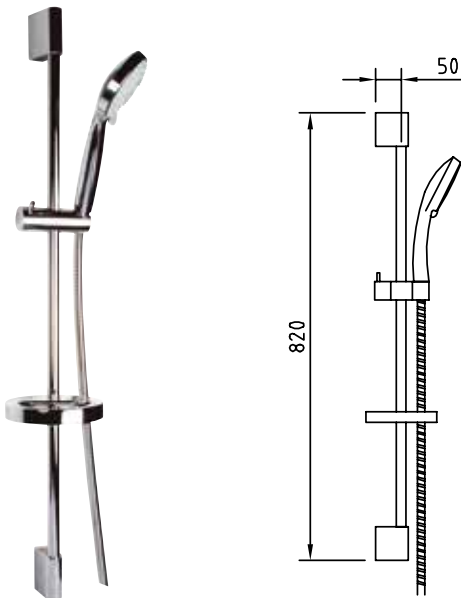
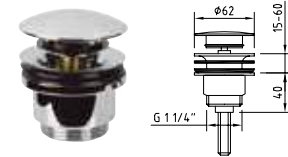

Conjunto de ducha SYVARI 3F
Shower Set SYVARI
Ensemble barre de douche SYVARI

Ref.	€	📦
98886	62,00	12*

Clever Box
 62 x 22 x 79 cm

*Pack indivisible de 12 unidades)
 *(Indivisible Packaging of 12 units)
 *(Pack indivisible de 12 unités)

CIRCULAR KIT SHOWER BOX

CONJUNTO BARRA DUCHA | Shower bar set
Colonne de douche

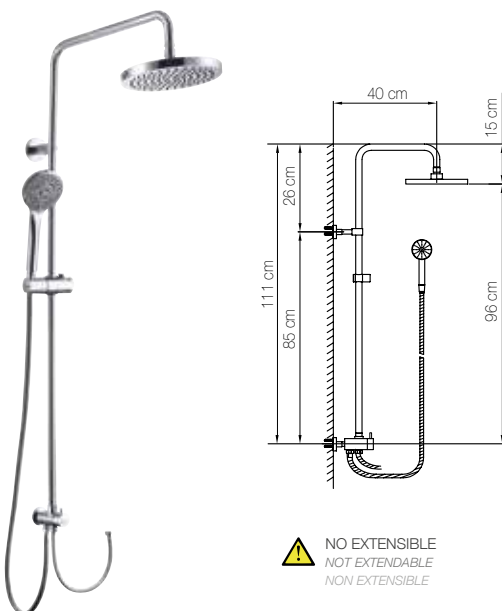

⚠️ NO EXTENSIBLE
NOT EXTENDABLE
NON EXTENSIBLE

Incluye
 Includes
 Inclus



Ref.	€	📦
99136	215,00	4*

Clever Box
 36 x 35 x 92 cm



*Pack indivisible de 4 unidades)
 *(Indivisible Packaging of 4 units)
 *(Pack indivisible de 4 unités)



COCINA



Chef
162



Abatible
Folding spout
Bec rabattable
172



Osmosis
Osmosis
Eau purifiée
174

Clever en tu cocina

Clever in your kitchen / Clever dans votre cuisine



Platinum
176



Styles
180



Styles Pro
186



Gerontológico
Medical lever
Manette P.M.R.
200

Cocina Kitchen / Cuisine

chef

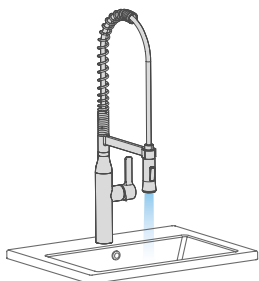

chef profesional
professional | industriel

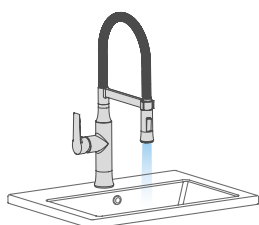

chef semi profesional
semi-professional | type industriel

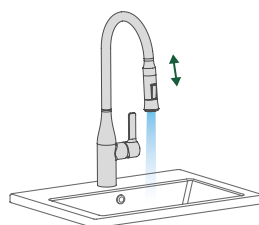

chef extraíble
pull out | extractible



chef básico
basic | simple

Platinum

Styles monomando

single lever | mitigeur

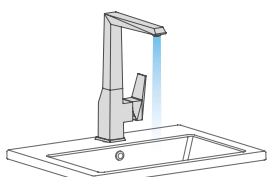

vertical
vertical | vertical



vertical
vertical | vertical

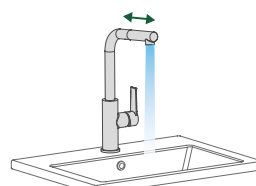

extraíble
pull out | extractible

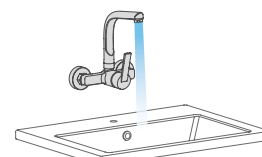

mural
wall mounted | mural

Styles pro monomando

single lever | mitigeur

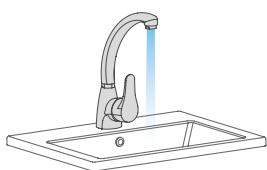

vertical
vertical | vertical

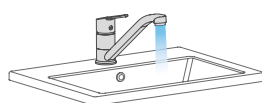

horizontal
horizontal | horizontal

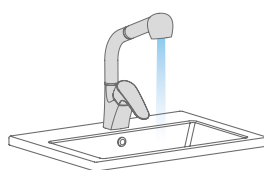

extraíble
pull out | extractible

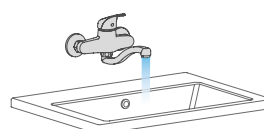

mural
wall mounted | mural



1 agua
1 water | 1 eau

Escoge el grifo que más encaja contigo

Choose your favorite tap / Choisissez votre robinet préféré

abatible

folding spout | bec rabattable

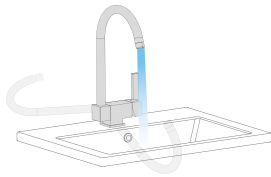

abatible

folding spout | bec rabattable

osmosis

osmosis | eau purifiée

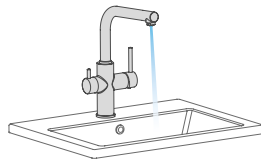

osmosis vertical

vertical osmosis | eau purifiée vertical

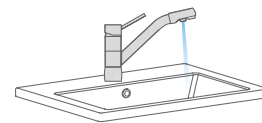

osmosis horizontal

horizontal osmosis | eau purifiée horizontal

Styles bimando

two handle | mélangeur



vertical

vertical | vertical

Gerontológico

medical lever | manette P.M.R.



vertical

vertical | vertical

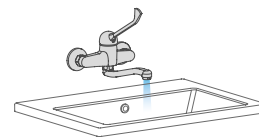

mural

wall mounted | mural

Styles pro bimando

two handle | mélangeur



vertical

vertical | vertical

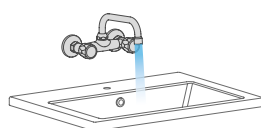

mural

wall mounted | mural



1 agua

1 water | 1 eau

Chef



chef profesional professional | industriel



PVD
Physical
Vapor
Deposition

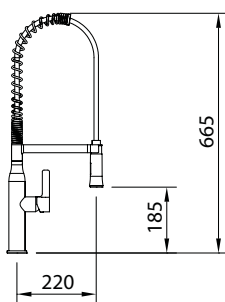

MATT Acabado en mate.
Matt finish. Fini mat

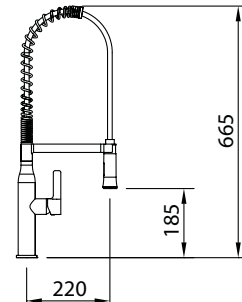

CHEF 5 MATT

FREGADERO

Sink mixer | Mitigeur évier douchette

Mezclador con aireador, caño giratorio, ducha con pulsador para lavavajillas, enlaces de alimentación flexibles M-10 3/8" x 370 mm.

Mixer with aerator, swivel spout, handset and flexible hoses M-10 3/8" x 370 mm.

Évier à bec orientable, ressort de guidage renforcé, douchette avec poussoir prélavage. Livré avec raccords flexibles M-10 3/8" x 370 mm

Ref.	€	📦
99445	343,00	4

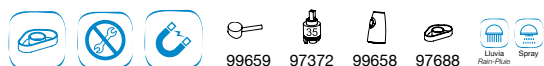

CHEF 5

FREGADERO

Sink mixer | Mitigeur évier douchette

Mezclador con aireador, caño giratorio, ducha con pulsador para lavavajillas, enlaces de alimentación flexibles M-10 3/8" x 370 mm.

Mixer with aerator, swivel spout, handset and flexible hoses M-10 3/8" x 370 mm.

Évier à bec orientable, ressort de guidage renforcé, douchette avec poussoir prélavage. Livré avec raccords flexibles M-10 3/8" x 370 mm

Ref.	€	📦
99444	306,00	4

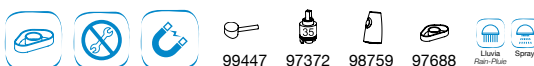

PVD
Physical
Vapor
Deposition

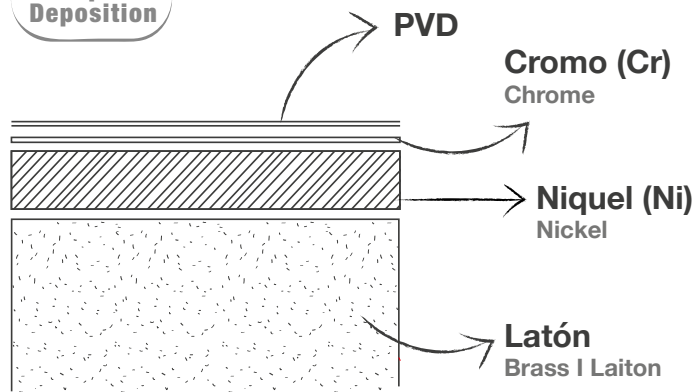

Tecnología PVD. Physical Vapor Deposition

Proceso de recubrimiento donde Nitruro de titanio es vaporizado y transportado al vacío para formar una unión molecular con la pieza a cubrir. El recubrimiento se condensa, formando una película para crear una superficie con **alta resistencia** al desgaste, rayaduras, golpes y corrosión.

Coating process where titanium nitride is vaporized and transported to an empty form with a molecular union to cover the piece. The coating is condensed, forming a film to create a surface with high resistance, postponing wear, scratches, blows and corrosion.

Processus de revêtement de nitrure de titane sous vide (PVD) créant une union moléculaire avec la pièce à couvrir.

Le revêtement se condense, formant une pellicule qui donne à la surface une grande résistance à l'usure, aux rayures, aux coups et à la corrosion.

Para / For / Pour :
Chef 5 MATT, 99445

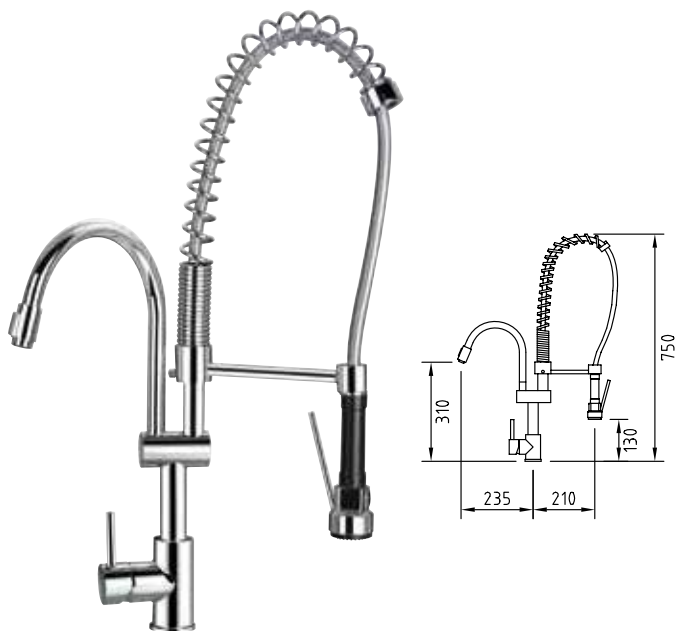

FREGADERO COLUMNA LAVAVAJILLAS 750

Sink mixer with swivel spout and dishwashing shower / Mitigeur évier industriel

Fregadero columna lavavajillas, inversor, caño lateral curvo, muelle resistente y ducha de pistola. Flexibles M-10 3/8" x 600 mm.

Sink column, diverter, curver lateral spout, strong spring, dishwashing shower. Flexible hoses M-10 3/8" x 600 mm.

Évier à bec orientable, ressort de guidage renforcé, douchette avec gachette pré-lavage. Livré avec raccords flexibles M-10 3/8" x 600 mm

	Ref.	€	
750 mm	ec1 97101	520,00	4

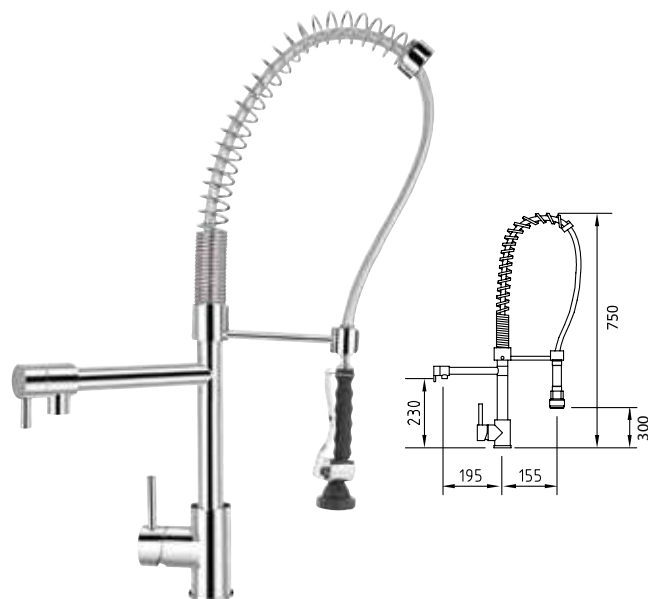
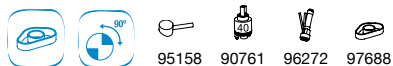

FREGADERO COLUMNA LAVAVAJILLAS 750

Sink mixer with swivel spout and dishwashing shower / Mitigeur évier industriel

Fregadero columna lavavajillas, caño lateral recto con palanca, muelle resistente, ducha de pistola y flexo 47cm. Flexibles M-10 3/8" x 600 mm.

Sink column, straight lateral spout, diverter, strong spring, dishwashing shower, hose 47cm. Flexible hoses M-10 3/8" x 600 mm.

Évier à bec orientable, ressort de guidage renforcé, douchette avec gachette pré-lavage. Livré avec raccords flexibles M-10 3/8" x 600 mm

	Ref.	€	
750 mm	ec1 96365	520,00	4

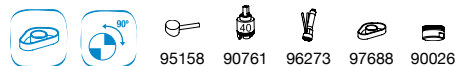

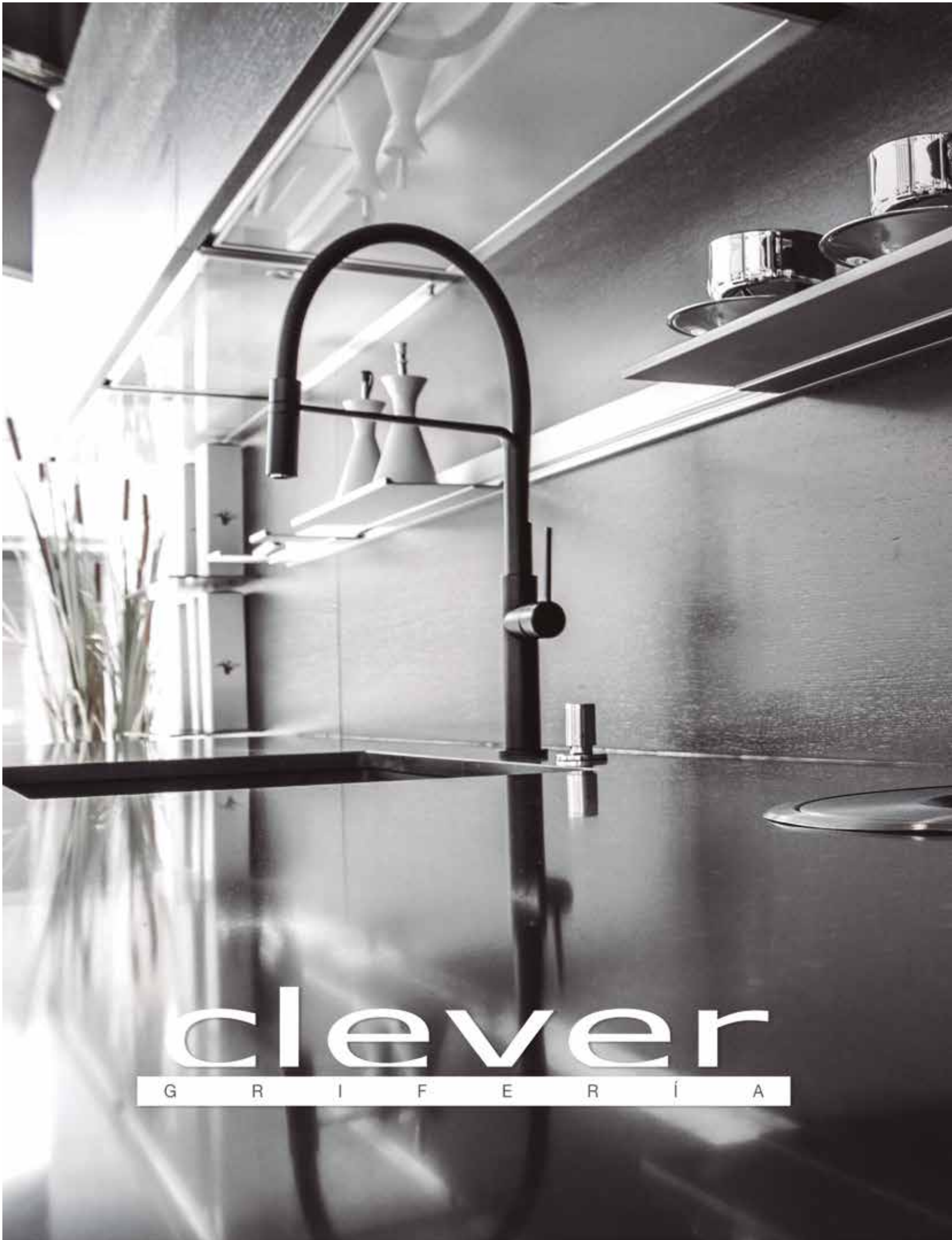

clever

G R I F E R Í A

CHEF SLIM

Moderno y funcional, elige tu estilo

Modern and functional, choose your style - Moderne et fonctionnel, choisissez votre style



Descubre acabados y características en:
Discover the finishes and characteristics in - Découvrez finitions et caractéristiques dans

www.griferiaclever.com/chefslim

chef semiprofesional

semi-professional I type industriel



Acabado en negro-Cromo.
Black-Chrome finish.
Finition noir - Chrome.

CHEF SLIM NEGRO CROMO

FREGADERO

Sink mixer | Mitigeur évier douchette

Mezclador con aireador, caño giratorio, enlces de alimentación flexibles M-10 3/8" x 370 mm.

Mixer with aerator, handset and flexible hoses M-10 3/8" x 370 mm.

Évier à bec orientable, ressort de guidage renforcé. Livré avec raccords flexibles M-10 3/8" x 370 mm

Ref.	€	📦
ec1 60148	220,00	4



Acabado en blanco-Cromo.
White-Chrome finish.
Finition blanc - Chrome.

CHEF SLIM BLANCO CROMO

FREGADERO

Sink mixer | Mitigeur évier douchette

Mezclador con aireador, caño giratorio, enlces de alimentación flexibles M-10 3/8" x 370 mm.

Mixer with aerator, handset and flexible hoses M-10 3/8" x 370 mm.

Évier à bec orientable, ressort de guidage renforcé. Livré avec raccords flexibles M-10 3/8" x 370 mm

Ref.	€	📦
ec1 60147	220,00	4

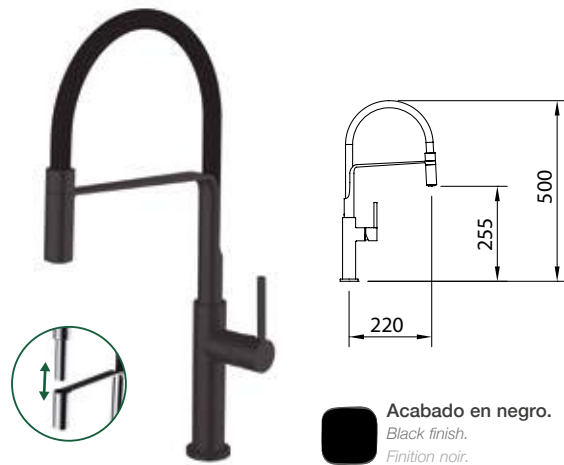

Acabado en negro.
Black finish.
Finition noir.

CHEF SLIM NEGRO

FREGADERO

Sink mixer | Mitigeur évier douchette

Mezclador con aireador, caño giratorio, enlces de alimentación flexibles M-10 3/8" x 370 mm.

Mixer with aerator, handset and flexible hoses M-10 3/8" x 370 mm.

Évier à bec orientable, ressort de guidage renforcé. Livré avec raccords flexibles M-10 3/8" x 370 mm

Ref.	€	📦
ec1 60146	205,00	4

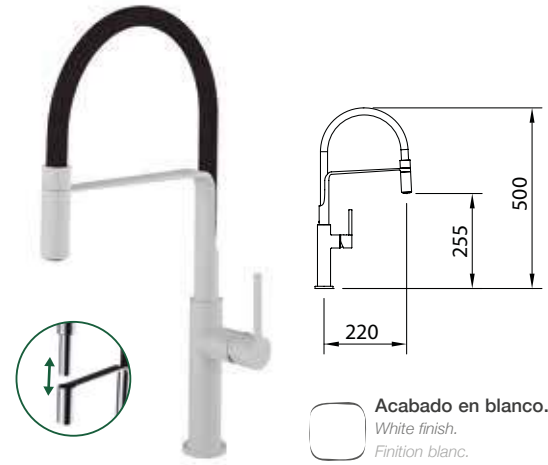

Acabado en blanco.
White finish.
Finition blanc.

CHEF SLIM BLANCO

FREGADERO

Sink mixer | Mitigeur évier douchette

Mezclador con aireador, caño giratorio, enlces de alimentación flexibles M-10 3/8" x 370 mm.

Mixer with aerator, handset and flexible hoses M-10 3/8" x 370 mm.

Évier à bec orientable, ressort de guidage renforcé. Livré avec raccords flexibles M-10 3/8" x 370 mm

Ref.	€	📦
ec1 60145	205,00	4





MATT Acabado en mate.
Matt finish. Fini mat

CHEF SLIM MATE

FREGADERO
Sink mixer | Mitigeur évier douchette

Mezclador con aireador, caño giratorio, enlaces de alimentación flexibles M-10 3/8" x 370 mm.
Mixer with aerator, handset and flexible hoses M-10 3/8" x 370 mm.
Évier à bec orientable, ressort de guidage renforcé. Livré avec raccords flexibles M-10 3/8" x 370 mm

Ref.	€	📦
ec1 60144	205,00	4



CHEF SLIM

FREGADERO
Sink mixer | Mitigeur évier douchette

Mezclador con aireador, caño giratorio, enlaces de alimentación flexibles M-10 3/8" x 370 mm.
Mixer with aerator, handset and flexible hoses M-10 3/8" x 370 mm.
Évier à bec orientable, ressort de guidage renforcé. Livré avec raccords flexibles M-10 3/8" x 370 mm

Ref.	€	📦
ec1 60143	185,00	4



CHEF CARBON

FREGADERO COLUMNA LAVAVAJILLAS
Sink mixer with swivel spout and dishwashing shower | Mitigeur évier industriel

Mezclador con aireador, caño giratorio, ducha con pulsador para lavavajillas, enlaces de alimentación flexibles M-10 3/8" x 370 mm.
Mixer with aerator, swivel spout, handset and flexible hoses M-10 3/8" x 370 mm.
Évier à bec orientable, ressort de guidage renforcé, douchette avec poussoir pré-lavage. Livré avec raccords flexibles M-10 3/8" x 370 mm

Ref.	€	📦
ec3 98757	295,00	4

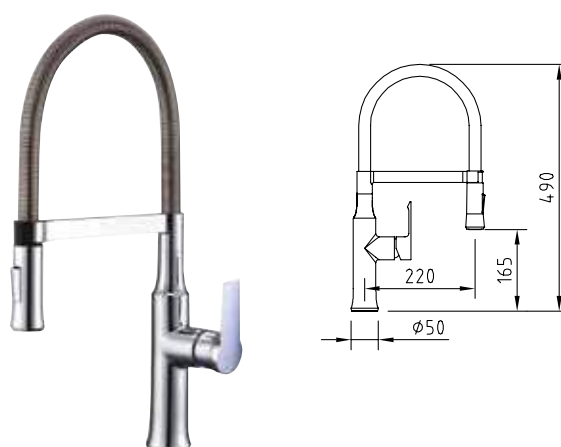
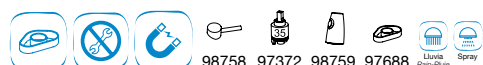

CHEF AGORA

FREGADERO COLUMNA LAVAVAJILLAS
Sink mixer with swivel spout and dishwashing shower | Mitigeur évier industriel

Mezclador con aireador, caño giratorio, ducha con pulsador para lavavajillas, enlaces de alimentación flexibles M-10 3/8" x 370 mm.
Mixer with aerator, swivel spout, handset and flexible hoses M-10 3/8" x 370 mm.
Évier à bec orientable, ressort de guidage renforcé, douchette avec poussoir pré-lavage. Livré avec raccords flexibles M-10 3/8" x 370 mm

Ref.	€	📦
ec2 98764	280,00	4

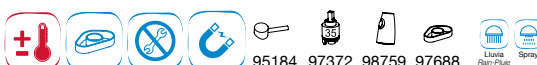

chef semiprofesional

semi-professional I type industriel

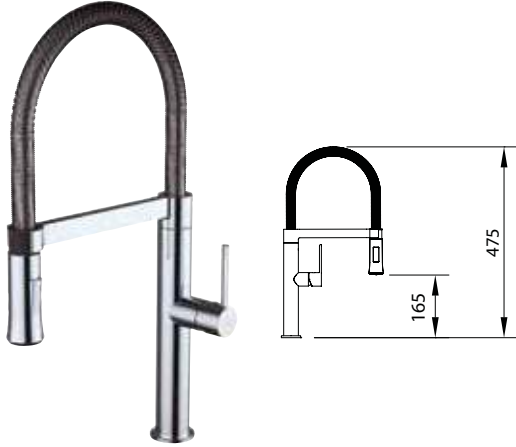

CHEF MAGNET SLIM

FREGADERO

Sink mixer | Mitigeur évier douchette

Mezclador con aireador, caño giratorio, ducha con pulsador para lavavajillas, enlaces de alimentación flexibles M-10 3/8" x 370 mm.
Mixer with aerator, swivel spout, handset and flexible hoses M-10 3/8" x 370 mm.

Évier à bec orientable, ressort de guidage renforcé, douchette avec poussoir pré-lavage. Livré avec raccords flexibles M-10 3/8" x 370 mm

Ref.	€	📦
ec1 60142	260,00	4

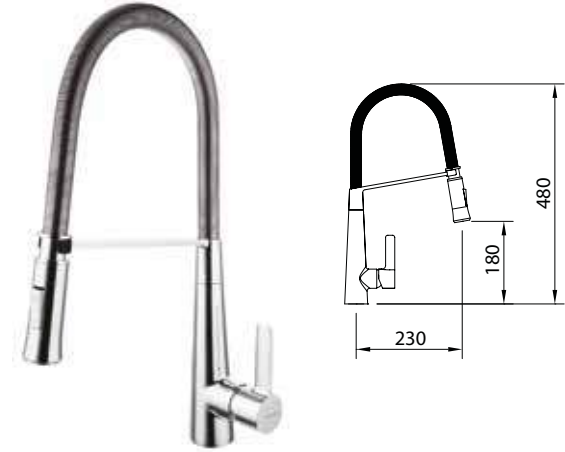

CHEF 4

FREGADERO

Sink mixer | Mitigeur évier douchette

Mezclador con aireador, caño giratorio, ducha con pulsador para lavavajillas, enlaces de alimentación flexibles M-10 3/8" x 420 mm.
Mixer with aerator, swivel spout, handset and flexible hoses M-10 3/8" x 420 mm.

Évier à bec orientable, ressort de guidage renforcé, douchette avec poussoir pré-lavage. Livré avec raccords flexibles M-10 3/8" x 420 mm

Ref.	€	📦
ec3 99443	223,00	4

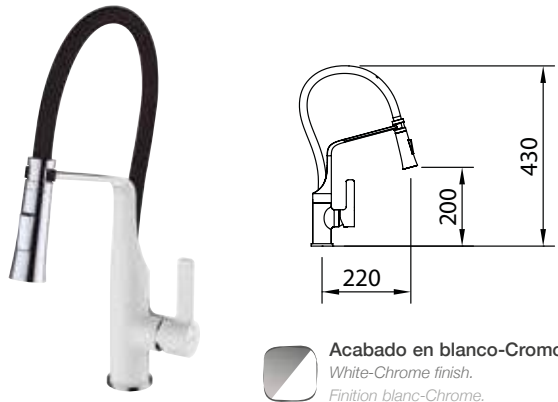
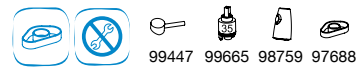

CHEF 6 BLANCO/CROMO

FREGADERO

Sink mixer | Mitigeur évier douchette

Mezclador con aireador, caño giratorio, ducha con pulsador para lavavajillas, enlaces de alimentación flexibles M-10 3/8" x 370 mm.
Mixer with aerator, swivel spout, handset and flexible hoses M-10 3/8" x 370 mm.

Évier à bec orientable, ressort de guidage renforcé, douchette avec poussoir pré-lavage. Livré avec raccords flexibles M-10 3/8" x 370 mm

Ref.	€	📦
ec3 99733	245,00	4

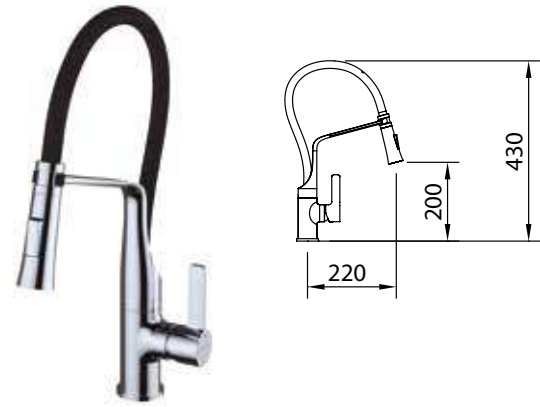
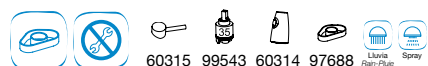

CHEF 6

FREGADERO

Sink mixer | Mitigeur évier douchette

Mezclador con aireador, caño giratorio, ducha con pulsador para lavavajillas, enlaces de alimentación flexibles M-10 3/8" x 370 mm.
Mixer with aerator, swivel spout, handset and flexible hoses M-10 3/8" x 370 mm.

Évier à bec orientable, ressort de guidage renforcé, douchette avec poussoir pré-lavage. Livré avec raccords flexibles M-10 3/8" x 370 mm

Ref.	€	📦
ec3 99735	205,00	4





CHEF 6
Fregadero
Sink Mixer
99733 Mitiger évier douchette

chef extraíble

pull out | extractible

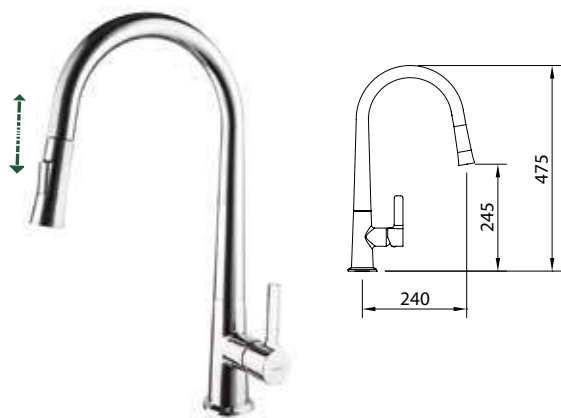

CHEF 3

FREGADERO EXTRAÍBLE

Pull-out sink mixer | Mitigeur évier douchette extractible

Mezclador con aireador, caño giratorio, ducha extraíble con pulsador para lavavajillas, enlaces de alimentación flexibles M-10 3/8" x 370 mm. Mixer with aerator, swivel spout, pull-out handset and flexible hoses M-10 3/8" x 370 mm.

Évier à bec orientable, douchette extractible avec poussoir prélevage. Livré avec raccords flexibles M-10 3/8" x 370 mm

	Ref.	€	📦
	99442	254,00	4

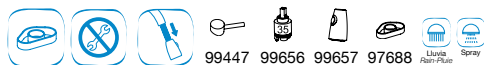

99447 99656 99657 97688

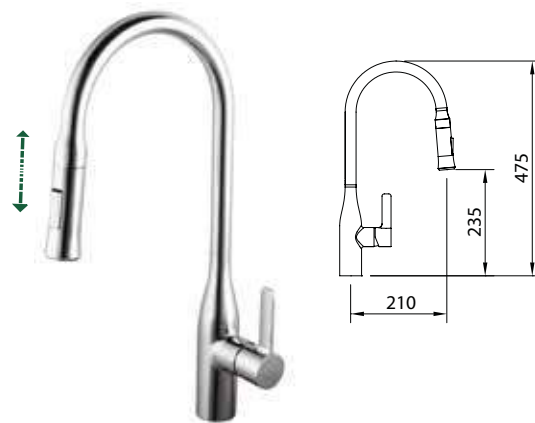

CHEF 2

FREGADERO EXTRAÍBLE

Pull-out sink mixer | Mitigeur évier douchette extractible

Mezclador con aireador, caño giratorio, ducha extraíble con pulsador para lavavajillas, enlaces de alimentación flexibles M-10 3/8" x 370 mm. Mixer with aerator, swivel spout, pull-out handset and flexible hoses M-10 3/8" x 370 mm.

Évier à bec orientable, douchette extractible avec poussoir prélevage. Livré avec raccords flexibles M-10 3/8" x 370 mm

	Ref.	€	📦
	99441	192,00	4

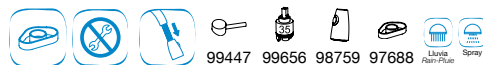

99447 99656 98759 97688

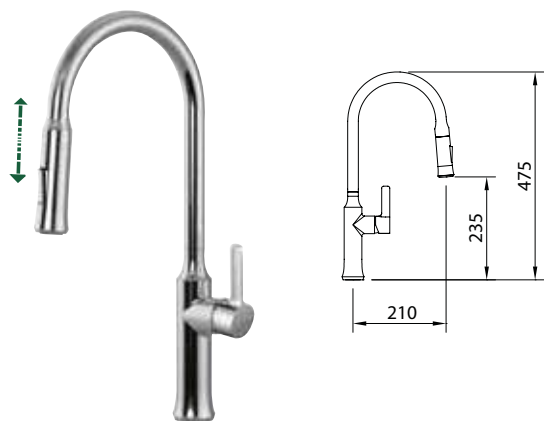

CHEF 1

FREGADERO EXTRAÍBLE

Pull-out sink mixer | Mitigeur évier douchette extractible

Mezclador con aireador, caño giratorio, ducha extraíble con pulsador para lavavajillas, enlaces de alimentación flexibles M-10 3/8" x 370 mm. Mixer with aerator, swivel spout, pull-out handset and flexible hoses M-10 3/8" x 370 mm.

Évier à bec orientable, douchette extractible avec poussoir prélevage. Livré avec raccords flexibles M-10 3/8" x 370 mm

	Ref.	€	📦
	99440	177,00	4

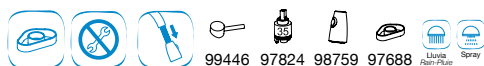

99446 97824 98759 97688



99442

CHEF 3
Fregadero
Sink Mixer
Mitigeur évier douchette



PVD
Physical Vapor Deposition

INOX Acabado en Inox.
Stainless finish. Fini inox



PVD
Physical Vapor Deposition

INOX Acabado en Inox.
Stainless finish. Fini inox

CURVE - Inox finishing

FREGADERO

Sink mixer | Mitigeur évier douchette

Mezclador con aireador, caño giratorio y flexibles M-10 3/8" x 420 mm.
Mixer with aerator, swivel spout, flexible hoses M-10 3/8" x 420 mm.
Mitigeur évier bec orientable, aérateur, raccords flexibles M-10 3/8" x 420 mm

RIGHT - Inox finishing

FREGADERO

Sink mixer | Mitigeur évier douchette

Mezclador con aireador, caño giratorio y flexibles M-10 3/8" x 420 mm.
Mixer with aerator, swivel spout, flexible hoses M-10 3/8" x 420 mm.
Mitigeur évier bec orientable, aérateur, raccords flexibles M-10 3/8" x 420 mm

	Ref.	€	
	ec1 99850	140,00	10



	Ref.	€	
	ec1 99851	140,00	10

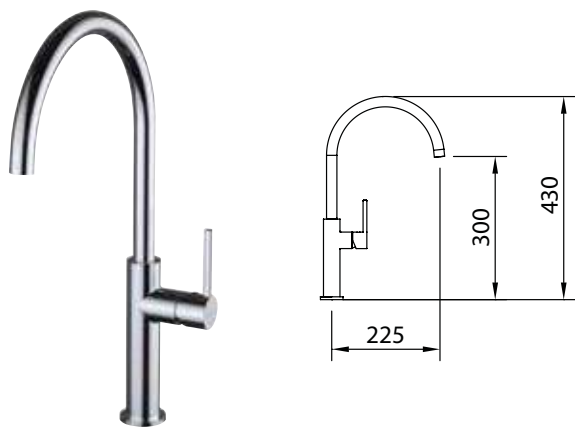

CHEF ESSENTIAL SLIM

FREGADERO

Sink mixer | Mitigeur évier douchette

Mezclador con aireador, caño giratorio, enlaces de alimentación flexibles M-10 3/8" x 370 mm.
Mixer with aerator, swivel spout, flexible hoses M-10 3/8" x 370 mm.
Évier à bec orientable, ressort de guidage renforcé. Livré avec raccords flexibles M-10 3/8" x 370 mm



CURVE INOX
Fregadero
Sink Mixer
99850 Mitigeur évier douchette

	Ref.	€	
	ec1 60141	155,00	4

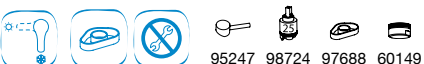

Abatible

Folding spout | Bec rabattable



Grifería abatible para fregaderos con ventanal.

Con esta grifería podrás abrir la ventana de la cocina sin obstáculos.

La grifería se inclina completamente evitando así que obstaculice la ventana. Se abate con un suave gesto, y dispone de varios puntos de fijación. Vuelve a su posición vertical fácilmente.

Practical solution for sinks below a window.

With this kitchen tap you can open the window without obstacles.

Practical solution for sink mixers below a window. With this kitchen tap you can open the window without any obstacle. The tap totally bends softly allowing to open the window without any inconvenience. You can return the spout to its original position easily.

Une robinetterie rabattable pour les éviers situés devant une fenêtre.

Avec ces robinets vous pourrez ouvrir la fenêtre de votre cuisine sans obstacles.

Les robinets s'inclinent complètement, sans gêner l'ouverture de la fenêtre. Ils se rabattent avec un simple geste, et disposent de plusieurs points de fixation. Ils retournent facilement à leur position verticale.

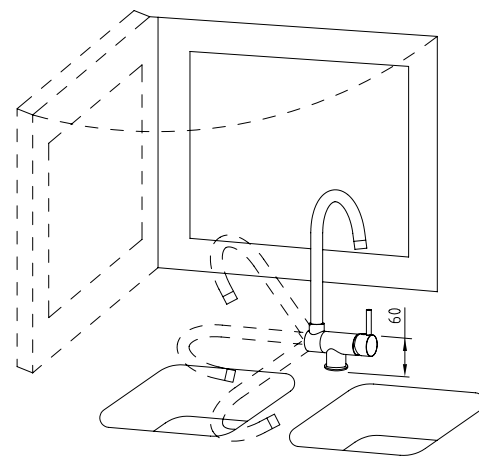

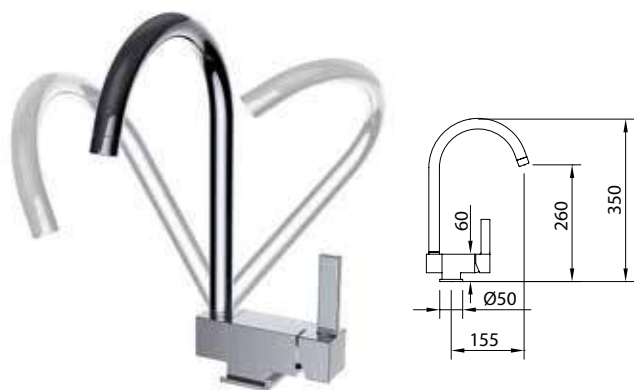

SQUARE ABATIBLE

FREGADERO CAÑO ABATIBLE

Sink mixer with folding spout / Mitigeur évier à bec rabattable

Fregadero caño abatible 180°, aireador, caño conformado giratorio, flexibles M-10 3/8" x 370 mm
 Deck mounted sink mixer 180° folding spout, aerator, swivel tube spout, flexible hoses M-10 3/8" x 370 mm.
 Mitigeur évier bec rabattable, aérateur, raccords flexibles M-10 3/8" x 370 mm

	Ref.	€	📦
	60152	163,00	4



95249 99656 97688 99232



FREGADERO CAÑO ABATIBLE

Sink mixer with folding spout / Mitigeur évier à bec rabattable

Fregadero caño abatible 180°, aireador, caño conformado giratorio, flexibles M-10 3/8" x 370 mm
 Deck mounted sink mixer 180° folding spout, aerator, swivel tube spout, flexible hoses M-10 3/8" x 370 mm.
 Mitigeur évier bec rabattable, aérateur, raccords flexibles M-10 3/8" x 370 mm

	Ref.	€	📦
	96095	120,00	8

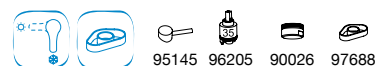

95145 96205 90026 97688

Osmosis

Osmosis | Eau purifiée

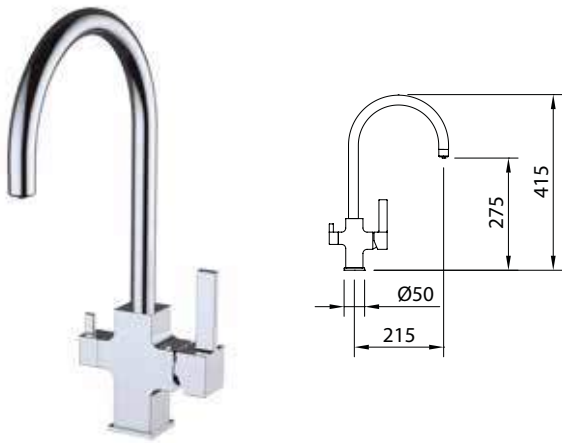

OSMOSIS SQUARE

FREGADERO OSMOSIS

Osmosis sink mixer | Mitigeur évier avec sortie eau purifiée

Fregadero Osmosis con 2 salidas de agua combinadas, flexibles M-10 3/8" x 370 mm
Sink mixer Osmosis with 2 outflows, flexible hoses M-10 3/8" x 370 mm.
Mitigeur évier pour eau purifiée, aérateur/buse intégré, raccords flexibles M-10 3/8" x 370 mm

	Ref.	€	📦
	60151	200,00	4

Incluye
Includes
Inclus



Adaptador para tubo PE 1/4" - 7/16"-24 H.
Adapter for PE 1/4" - 7/16"-24 F pipe.
Adaptateur tubo PE 1/4" - 7/16"-24 H.



95249 95251 99656 97688 60153

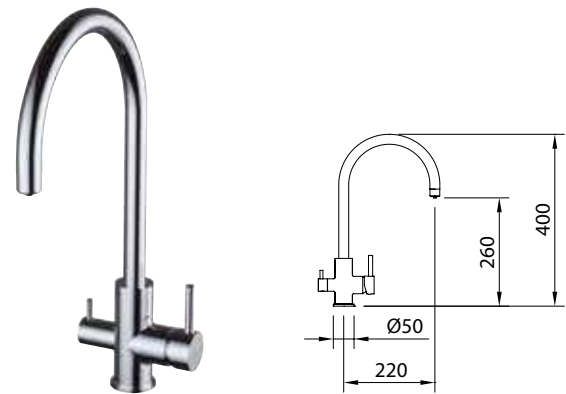

OSMOSIS ROUND

FREGADERO OSMOSIS

Osmosis sink mixer | Mitigeur évier avec sortie eau purifiée

Fregadero Osmosis con 2 salidas de agua combinadas, flexibles M-10 3/8" x 370 mm
Sink mixer Osmosis with 2 outflows, flexible hoses M-10 3/8" x 370 mm.
Mitigeur évier pour eau purifiée, aérateur/buse intégré, raccords flexibles M-10 3/8" x 370 mm

	Ref.	€	📦
	60150	173,00	4

Incluye
Includes
Inclus



Adaptador para tubo PE 1/4" - 7/16"-24 H.
Adapter for PE 1/4" - 7/16"-24 F pipe.
Adaptateur tubo PE 1/4" - 7/16"-24 H.



95248 95250 99656 97688 60153

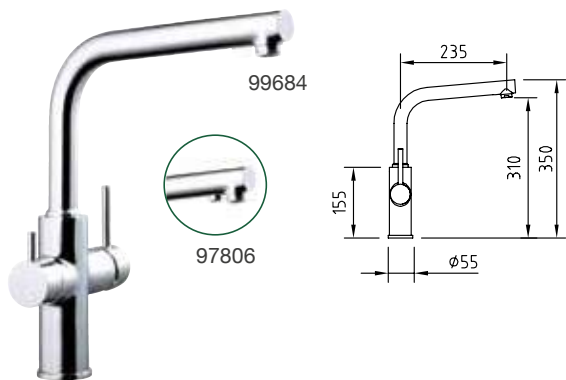

FREGADERO OSMOSIS
Osmosis sink mixer | Mitigeur évier avec sortie eau purifiée

Fregadero Osmosis con 2 salidas de agua combinadas, flexibles M-10 3/8" x 370 mm
 Sink mixer Osmosis with 2 outflows, flexible hoses M-10 3/8" x 370 mm.
 Mitigeur évier pour eau purifiée, aérateur/buse intégré, raccords flexibles M-10 3/8" x 370 mm

	Ref.	€	Q
	99684	183,00	4
	97806	183,00	4

		95145	98631	97371	97698	97688	99737	90025 ø24	96202 ø20

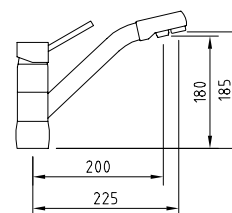

FREGADERO OSMOSIS
Osmosis sink mixer | Mitigeur évier avec sortie eau purifiée

Fregadero Osmosis con 2 salidas de agua, caño giratorio, flexibles M-10 3/8" x 370 mm
 Sink mixer Osmosis with 2 outflows, swivel spout, flexible hoses M-10 3/8" x 370 mm.
 Mitigeur évier pour eau purifiée, aérateur/buse, raccords flexibles M-10 3/8" x 370 mm

	Ref.	€	Q
	98760	200,00	8

Incluye Includes		97399	Adaptador para tubo PE 1/4" - 7/16"-24 H. Adapter for PE 1/4" - 7/16"-24 F pipe. Adaptateur tubo PE 1/4" - 7/16"-24 H.						
		98778	98632	97370	97697	90025	96202		

SISTEMA SALIDA OSMOSIS
Ref. 99684 - 60150 - 60151

Outlet osmosis system / Système de sortie d'eau purifiée

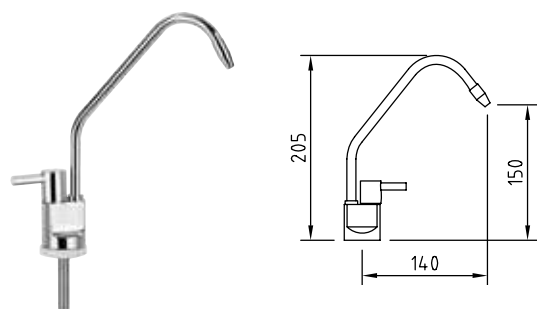

GRIFERÍA OSMOSIS
Osmosis sink | Robinet avec sortie eau purifiée

Grifería osmosis, caño giratorio.
 Osmosis sink, swivel spout.
 Robinet évier pour eau purifiée, avec buse

	Ref.	€	Q
	97104	45,00	20

Incluye
Includes

	97399	Adaptador para tubo PE 1/4" - 7/16"-24 H. Adapter for PE 1/4" - 7/16"-24 F pipe. Adaptateur tubo PE 1/4" - 7/16"-24 H.
--	-------	--



Salida de agua mezclada
Mixed water outlet
Sortie d'eau mitigée

Salida de agua tratada (osmosis)
Treated water outlet (osmosis)
Sortie d'eau purifiée

No existe comunicación entre el conducto de agua mezclada y el de agua tratada.
 It does not exist any contact between the mixed water channel and the treated one.
 Il n'y a aucun contact entre l'eau mitigée et l'eau purifiée

Platinum

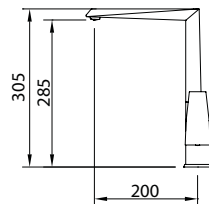

VENTU 285 mm

FREGADERO

Sink mixer | Mitigeur évier

Mezclador con aireador, caño fundido giratorio, flexibles M-10 3/8" x 370 mm.
Mixer with aerator, swivel cast spout, flexible hoses M-10 3/8" x 370 mm.
Mitigeur évier bec orientable, aérateur, raccords flexibles M-10 3/8" x 370 mm.

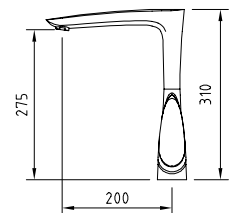

AUDE 275 mm

FREGADERO

Sink mixer | Mitigeur évier

Mezclador con aireador, caño fundido giratorio, flexibles M-10 3/8" x 370 mm.
Mixer with aerator, swivel cast spout, flexible hoses M-10 3/8" x 370 mm.
Mitigeur évier bec orientable, aérateur, raccords flexibles M-10 3/8" x 370 mm.

	Ref.	€	📦
	99438	335,00	8
	99708	339,00	8

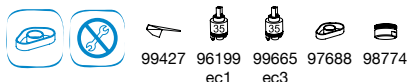

	Ref.	€	📦
	97815	285,00	8





SELENE 290 mm

FREGADERO
Sink mixer | Mitigeur évier

Mezclador con aireador, caño fundido giratorio, flexibles M-10 3/8" x 370 mm.
Mixer with aerator, swivel cast spout, flexible hoses M-10 3/8" x 370 mm.
Mitigeur évier bec orientable, aérateur, raccords flexibles M-10 3/8" x 370 mm

	Ref.	€	📦
	ec1 98014	261,00	8

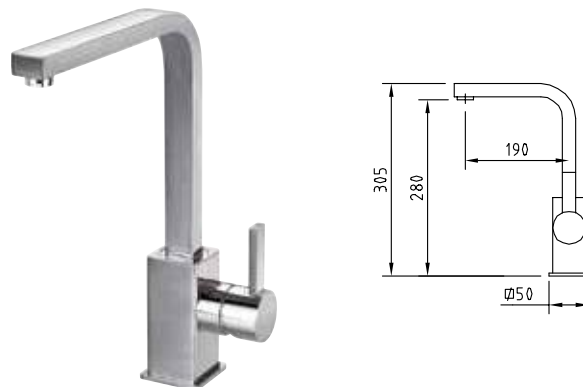
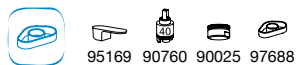

BIMINI 280 mm

FREGADERO
Sink mixer | Mitigeur évier

Mezclador con aireador, caño conformado giratorio, flexibles M-10 3/8" x 370 mm.
Mixer with aerator, swivel tube spout, flexible hoses M-10 3/8" x 370 mm.
Mitigeur évier bec orientable, aérateur, raccords flexibles M-10 3/8" x 370 mm

	Ref.	€	📦
	97046	225,00	8

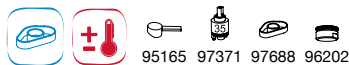

MARINA EVO 270mm

FREGADERO
Sink mixer | Mitigeur évier

Mezclador con aireador, caño conformado giratorio, flexibles M-10 3/8" x 420 mm.
Mixer with aerator, swivel tube spout, flexible hoses M-10 3/8" x 420 mm.
Mitigeur évier bec orientable, aérateur, raccords flexibles M-10 3/8" x 420 mm

	Ref.	€	📦
	ec1 99423	203,00	8
	ec3 99715	207,00	8

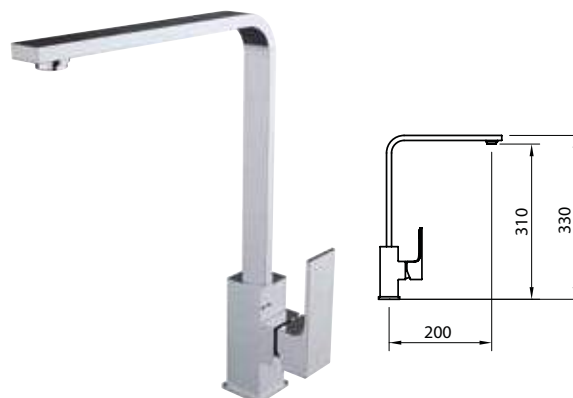

SAONA SLIM 310 mm

FREGADERO
Sink mixer | Mitigeur évier

Mezclador con aireador, caño tubo giratorio, flexibles M-10 3/8" x 370 mm.
Mixer with aerator, swivel spout, flexible hoses M-10 3/8" x 370 mm.
Mitigeur évier bec orientable, aérateur, raccords flexibles M-10 3/8" x 370 mm.

	Ref.	€	📦
	ec1 60128	171,00	8

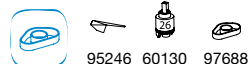

Platinum

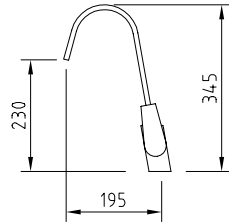

PAULA 230 mm

FREGADERO
Sink mixer | Mitigeur évier douchette

Mezclador con rompeaguas, caño conformado giratorio, flexibles M-10 3/8" x 370 mm.

Mixer with water breaker, swivel tube spout, flexible hoses M-10 3/8" x 370 mm.

Mitigeur évier bec orientable, brise-jet, raccords flexibles M-10 3/8" x 370 mm

	Ref.	€	
 ec1	98201	171,00	8



9 l/m, 3 bar

98216

96199

97688



98201

PAULA
Fregadero
Sink Mixer
Mitiger évier



AUDE
Fregadero
Sink Mixer
97815 Mitiger évier



60128 | SAONA SLIM
Fregadero
Sink Mixer
Mitiger évler

Styles



monomando vertical

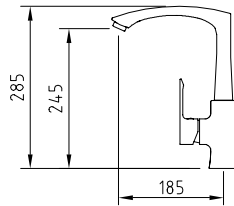

vertical single lever | mitigeur vertical



AGORA elegance 245 mm

FREGADERO
Sink mixer | Mitigeur évier

Mezclador con aireador, caño fundido giratorio, flexibles M-10 3/8" x 370 mm.
Mixer with aerator, swivel cast spout, flexible hoses M-10 3/8" x 370 mm.
Mitigeur évier bec orientable, aérateur, raccords flexibles M-10 3/8" x 370 mm

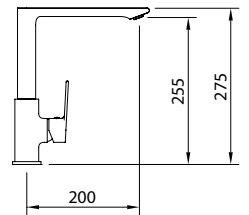

	Ref.	€	
 	98684	163,00	8



AGORA xtreme 255 mm

FREGADERO
Sink mixer | Mitigeur évier

Mezclador con aireador, caño fundido giratorio, flexibles M-10 3/8" x 420 mm.
Mixer with aerator, swivel cast spout, flexible hoses M-10 3/8" x 420 mm.
Mitigeur évier bec orientable, aérateur, raccords flexibles M-10 3/8" x 420 mm.

	Ref.	€	
  	60113	163,00	-



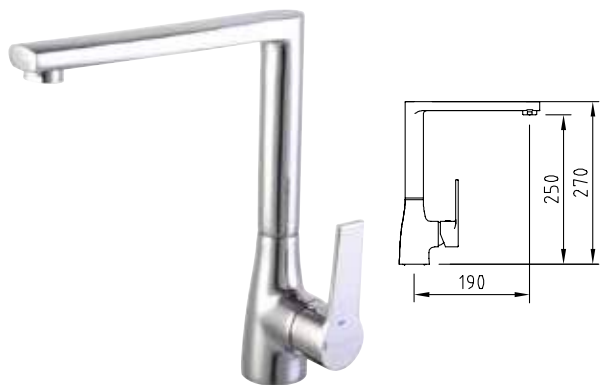

ARTIC Xtreme 250 mm

FREGADERO
Sink mixer | Mitigeur évier

Mezclador con aireador, caño fundido giratorio, flexibles M-10 3/8" x 370 mm.
Mixer with aerator, swivel cast spout, flexible hoses M-10 3/8" x 370 mm.
Mitigeur évier bec orientable, aérateur, raccords flexibles M-10 3/8" x 370 mm



ARTIC Xtreme 320 mm

FREGADERO
Sink mixer | Mitigeur évier

Mezclador con aireador, caño giratorio, flexibles M-10 3/8" x 370 mm.
Mixer with aerator, swivel spout, flexible hoses M-10 3/8" x 370 mm.
Mitigeur évier bec orientable, aérateur, raccords flexibles M-10 3/8" x 370 mm

	Ref.	€	📦
	98694	160,00	8
	95186 99656 90025 97688		

	Ref.	€	📦
	99108	150,00	4
	95186 99656 97688 96202		



ARTIC Urban 275 mm

FREGADERO
Sink mixer | Mitigeur évier

Mezclador con aireador, caño conformado giratorio, flexibles M-10 3/8" x 420 mm.
Mixer with aerator, swivel tube spout, flexible hoses M-10 3/8" x 420 mm.
Mitigeur évier bec orientable, aérateur, raccords flexibles M-10 3/8" x 420 mm



CAIMAN elegance 230 mm

FREGADERO
Sink mixer | Mitigeur évier

Mezclador con aireador, caño conformado giratorio, flexibles M-10 3/8" x 370 mm.
Mixer with aerator, swivel tube spout, flexible hoses M-10 3/8" x 370 mm.
Mitigeur évier bec orientable, aérateur, raccords flexibles M-10 3/8" x 370 mm

	Ref.	€	📦
	98107	160,00	5
	98241 98238 90026 97688		

	Ref.	€	📦
	97086	162,00	8
	96205 98601 97688		

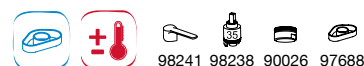

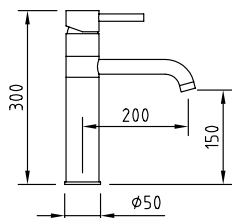

CAIMAN elegance 230 mm

FREGADERO
Sink mixer | Mitigeur évier

Mezclador con caño giratorio con aireador y flexibles M-10 3/8" x 600 mm.
Mixer, aerator swivel spout, flexible hoses M-10 3/8" x 600 mm.
Mitigeur évier bec orientable, aérateur, raccords flexibles M-10 3/8" x 600 mm

	Ref.	€	📦
	ec1 60161	150,00	20

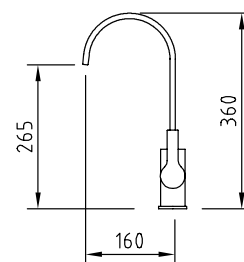
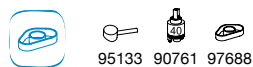

CAIMAN Xtreme 265 mm

FREGADERO
Sink mixer | Mitigeur évier

Mezclador con aireador, caño giratorio, flexibles M-10 3/8" x 370 mm.
Mixer with aerator, swivel spout, flexible hoses M-10 3/8" x 370 mm.
Mitigeur évier bec orientable, aérateur, raccords flexibles M-10 3/8" x 370 mm

	Ref.	€	📦
	ec1 98190	150,00	8

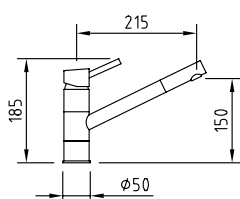

CAIMAN urban 150 mmmm

FREGADERO
Sink mixer | Mitigeur évier

Mezclador con caño giratorio con aireador y flexibles M-10 3/8" x 370 mm.
Mixer, aerator swivel spout, flexible hoses M-10 3/8" x 370 mm.
Mitigeur évier bec orientable, aérateur, raccords flexibles M-10 3/8" x 370 mm

	Ref.	€	📦
	ec2 92603	127,00	8

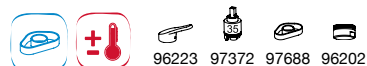

AGORA *elegance*
Fregadero
Sink Mixer
98684 | *Mitiger évier*



monomando extraíble

pull out single lever | mitigeur extractible



ARTIC xtreme 265 mm

FREGADERO EXTRAÍBLE

Pull-out sink mixer | Mitigeur évier douchette extractible

Mezclador con aireador, caño giratorio, ducha extraíble con pulsador para lavavajillas, enlaces de alimentación flexibles M-10 3/8" x 370 mm.
Mixer with aerator, swivel spout, pull-out handset and flexible hoses M-10 3/8" x 370 mm.

Mitigeur évier bec orientable, aérateur, douchette extractible avec poussoir pré-lavage, raccords flexibles M-10 3/8" x 370 mm

	Ref.	€	
	98689	190,00	4

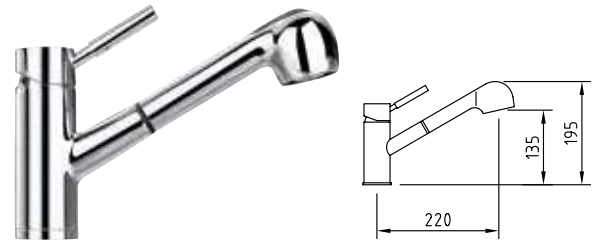

CAIMAN elegance 135 mm

FREGADERO EXTRAÍBLE

Pull-out sink mixer | Mitigeur évier douchette extractible

Mezclador con aireador, caño giratorio, flexibles M-10 3/8" x 370 mm.
Mixer with aerator, swivel spout, flexible hoses M-10 3/8" x 370 mm.

Mitigeur évier bec orientable, aérateur, raccords flexibles M-10 3/8" x 370 mm

	Ref.	€	
 Extrahable 90794	 1,50 m 96117		97069 192,00 8

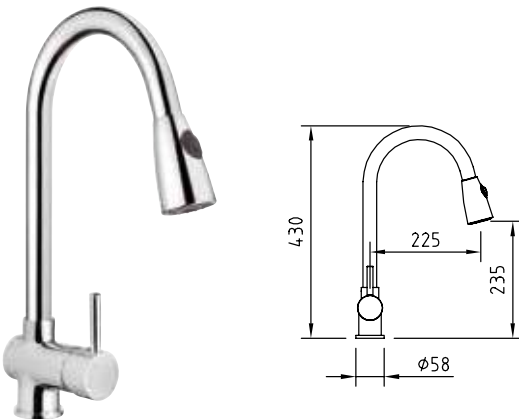
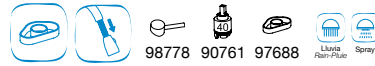

CAIMAN urban 235 mm

FREGADERO EXTRAÍBLE

Pull-out sink mixer | Mitigeur évier douchette extractible

Mezclador con aireador, caño giratorio, ducha extraíble con pulsador para lavavajillas, enlaces de alimentación flexibles M-10 3/8" x 370 mm.
Mixer with aerator, swivel spout, pull-out handshower and flexible hoses M-10 3/8" x 370 mm.

Mitigeur évier bec orientable, douchette extractible, aérateur, raccords flexibles M-10 3/8" x 370 mm

	Ref.	€	
 1,50 m 96117		97804 212,00	4

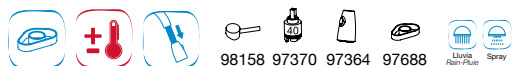

bimando vertical

vertical two handle | mélangeur vertical

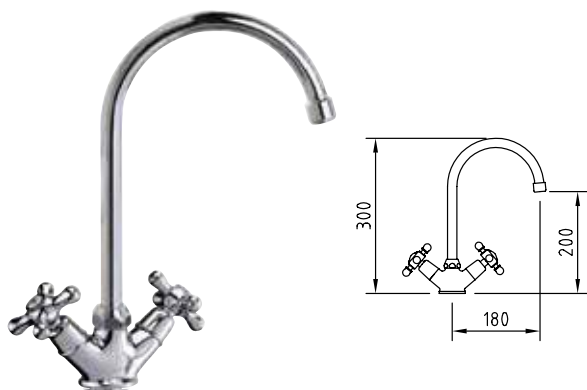

WITH2 antigua 200 mm

FREGADERO

Sink mixer | Mitigeur évier

Mezclador con aireador, caño conformado giratorio, flexibles M-10 3/8" x 370 mm.
Mixer with aerator, swivel tube spout, flexible hoses M-10 3/8" x 370 mm.
Mélangeur évier, bec orientabl, eaérateur, raccords flexibles M-10 3/8" x 370 mm

	Ref.	€	
	92049	63,00	8



94600 96208 90026

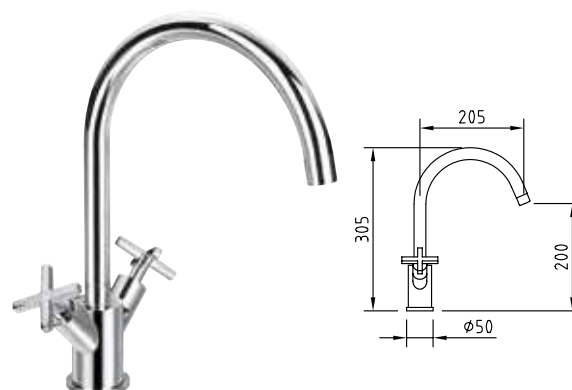

WITH2 morea 200 mm

FREGADERO

Sink mixer | Mitigeur évier

Mezclador con aireador, caño giratorio, flexibles M-10 3/8" x 370 mm.
Mezclador con aireador, caño conformado giratorio, flexibles M-10 3/8" x 370 mm.

Mixer with aerator, swivel tube spout, flexible hoses M-10 3/8" x 370 mm.
Mélangeur évier, bec orientabl, eaérateur, raccords flexibles M-10 3/8" x 370 mm

	Ref.	€	
	97005	147,00	8



95126 97688

Styles Pro



monomando vertical
vertical single lever | mitigeur vertical

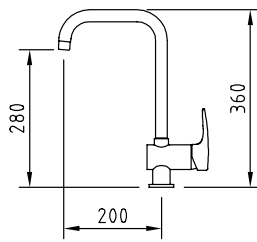

BAHAMA Xtreme 280 mm

FREGADERO
Sink mixer | Mitigeur évier

Mezclador con aireador, caño conformado giratorio y flexibles M-10 3/8" x 420 mm.
Mixer, aerator, swivel tube spout, flexible hoses M-10 3/8" x 420 mm.
Mitigeur évier bec orientable, aérateur, raccords flexibles M-10 3/8" x 420 mm

	Ref.	€	📦
	98913	148,00	8
	98179	153,00	8

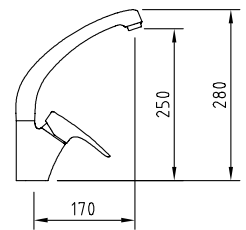
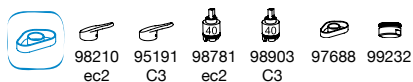

HABANA Xtreme 250 mm

FREGADERO
Sink mixer | Mitigeur évier

Mezclador con aireador, caño conformado giratorio y flexibles M-10 3/8" x 370 mm.
Mixer, aerator, swivel tube spout, flexible hoses M-10 3/8" x 370 mm.
Mitigeur évier bec orientable, aérateur, raccords flexibles M-10 3/8" x 370 mm

	Ref.	€	📦
	98917	119,00	8
	98169	121,00	8

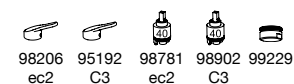



START elegance 260 mm

FREGADERO
Sink mixer | Mitigeur évier

Mezclador con aireador, caño conformado giratorio y flexibles M-10 3/8" x 370 mm
Mixer, aerator, swivel tube spout, flexible hoses M-10 3/8" x 370 mm.
Mitigeur évier bec orientable, aérateur, raccords flexibles M-10 3/8" x 370 mm

	Ref.	€	📦
ec1	60183	84,00	8

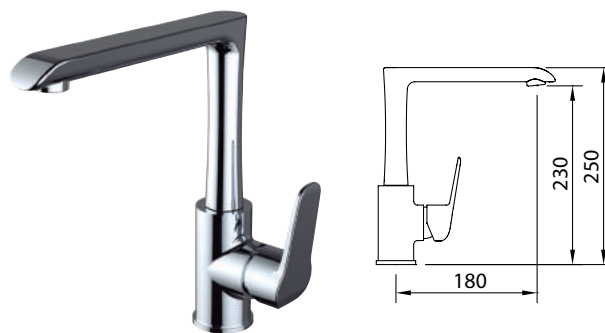

START elegance 230 mm

FREGADERO
Sink mixer | Mitigeur évier

Mezclador con aireador, caño fundido giratorio y flexibles M-10 3/8" x 370 mm
Mixer, aerator, swivel spout, flexible hoses M-10 3/8" x 370 mm.
Mitigeur évier bec orientable, aérateur, raccords flexibles M-10 3/8" x 370 mm

	Ref.	€	📦
ec1	60184	102,00	8

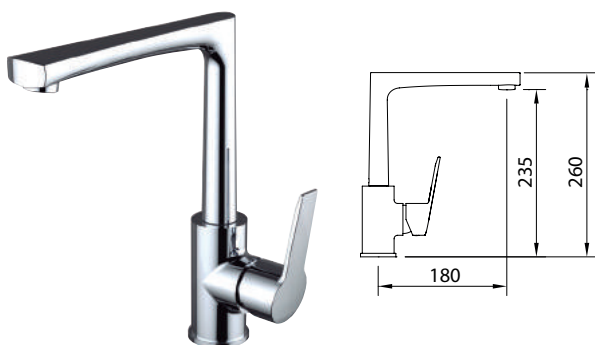

START Xtreme 235 mm

FREGADERO
Sink mixer | Mitigeur évier

Mezclador con aireador, caño fundido giratorio, flexibles M-10 3/8" x 370 mm.
Mixer with aerator, swivel cast spout, flexible hoses M-10 3/8" x 370 mm.
Mitigeur évier bec orientable, aérateur, raccords flexibles M-10 3/8" x 370 mm

	Ref.	€	📦
ec1	60198	97,00	8



START Urban 255 mm

FREGADERO
Sink mixer | Mitigeur évier

Mezclador con aireador, caño conformado giratorio, flexibles M-10 3/8" x 420 mm.
Mixer with aerator, swivel tube spout, flexible hoses M-10 3/8" x 420 mm.
Mitigeur évier bec orientable, aérateur, raccords flexibles M-10 3/8" x 420 mm

	Ref.	€	📦
ec2	98921	85,00	12
ec3	98615	89,00	12

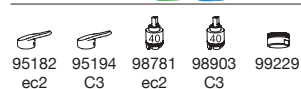



START urban 245 mm

FREGADERO
Sink mixer | Mitigeur évier

Mezclador con aireador, caño fundido giratorio, flexibles M-10 3/8" x 420 mm.

Mixer with aerator, swivel cast spout, flexible hoses M-10 3/8" x 420 mm.

Mitigeur évier bec orientable, aérateur, raccords flexibles M-10 3/8" x 420 mm

	Ref.	€	📦
	98922	97,00	12
	98614	99,00	12

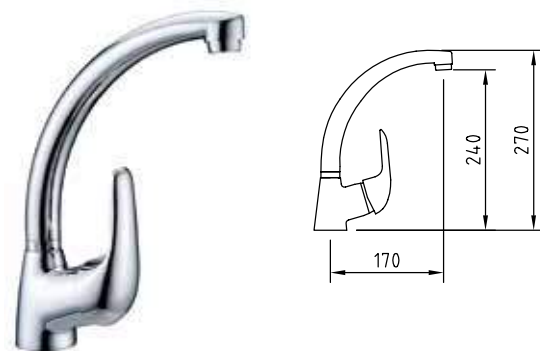
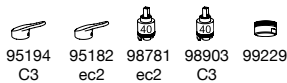

PANAM elegance 240 mm

FREGADERO
Sink mixer | Mitigeur évier

Mezclador con aireador, caño conformado giratorio, flexibles M-10 3/8" x 370 mm.

Mixer with aerator, swivel tube spout, flexible hoses M-10 3/8" x 370 mm.

Mitigeur évier bec orientable, aérateur, raccords flexibles M-10 3/8" x 370 mm

	Ref.	€	📦
	96344	72,00	12

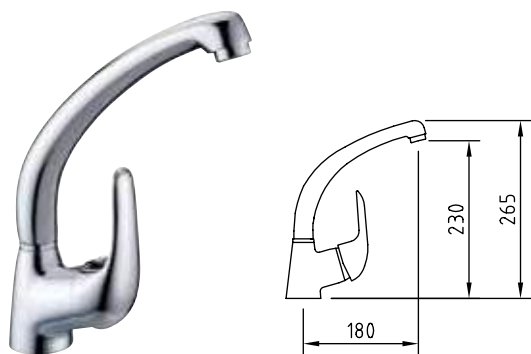

PANAM elegance 230 mm

FREGADERO
Sink mixer | Mitigeur évier

Mezclador con aireador, caño fundido giratorio, flexibles M-10 3/8" x 370 mm.

Mixer with aerator, swivel cast spout, flexible hoses M-10 3/8" x 370 mm.

Mitigeur évier bec orientable, aérateur, raccords flexibles M-10 3/8" x 370 mm

	Ref.	€	📦
	96345	78,00	12

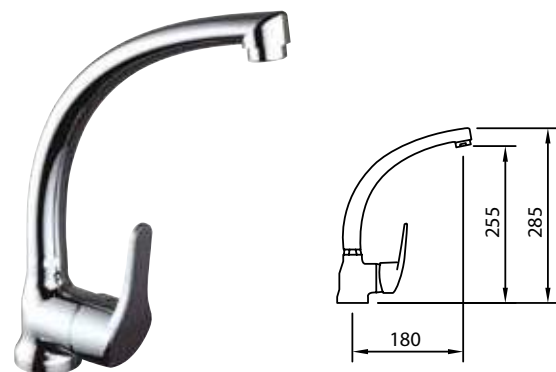

PANAM Xtreme 255 mm

FREGADERO
Sink mixer | Mitigeur évier

Mezclador con aireador, caño conformado giratorio, flexibles M-10 3/8" x 370 mm.

Mixer with aerator, swivel tube spout, flexible hoses M-10 3/8" x 370 mm.

Mitigeur évier bec orientable, aérateur, raccords flexibles M-10 3/8" x 370 mm

	Ref.	€	📦
	98767	72,00	12



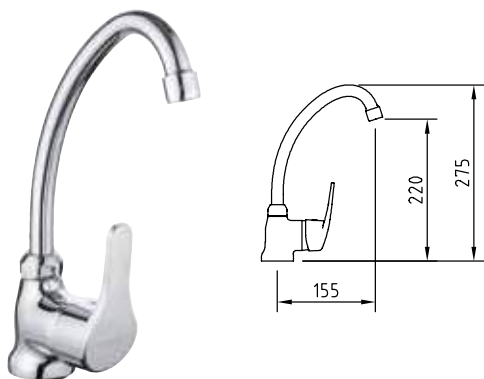

PANAM Xtreme 220 mm

FREGADERO
Sink mixer | Mitigeur évier

Mezclador con aireador, caño conformado giratorio, flexibles M-10 3/8" x 370 mm.
Mixer with aerator, swivel tube spout, flexible hoses M-10 3/8" x 370 mm.
Mitigeur évier bec orientable, aérateur, raccords flexibles M-10 3/8" x 370 mm

	Ref.	€	
ec1	98145	69,00	12

95173 98237 99232

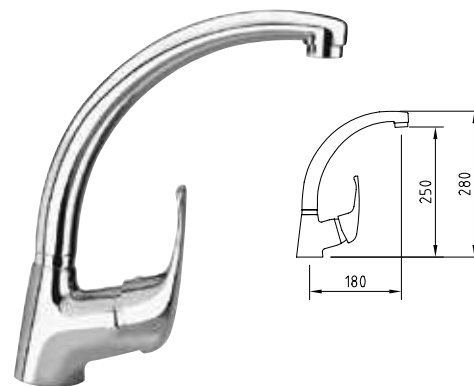

PANAM Urban 250 mm

FREGADERO
Sink mixer | Mitigeur évier

Mezclador con aireador, caño conformado giratorio y flexibles M-10 3/8" x 370 mm.
Mixer, aerator, swivel tube spout, flexible hoses M-10 3/8" x 370 mm.
Mitigeur évier bec orientable, aérateur, raccords flexibles M-10 3/8" x 370 mm

	Ref.	€	
ec1	92350	72,00	12

95110 90760 90025

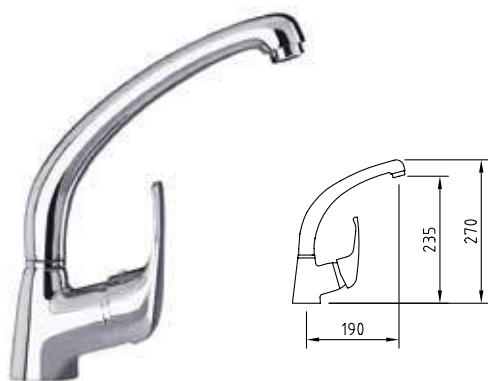

PANAM Urban 235 mm

FREGADERO
Sink mixer | Mitigeur évier

Mezclador con aireador, caño fundido giratorio, flexibles M-10 3/8" x 370 mm.
Mixer with aerator, swivel cast spout, flexible hoses M-10 3/8" x 370 mm.
Mitigeur évier bec orientable, aérateur, raccords flexibles M-10 3/8" x 370 mm

	Ref.	€	
ec1	92351	78,00	12

95110 90760 99229

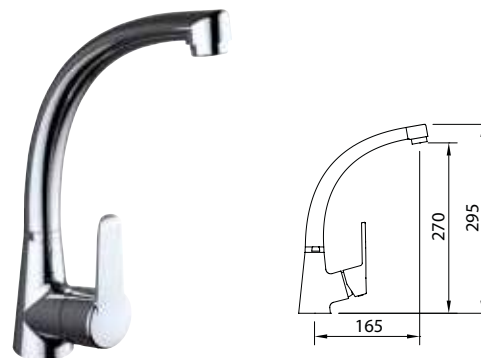

S12 elegance 270 mm

FREGADERO
Sink mixer | Mitigeur évier

Mezclador con aireador, caño conformado giratorio, flexibles M-10 3/8" x 370 mm.
Mixer with aerator, swivel tube spout, flexible hoses M-10 3/8" x 370 mm.
Mitigeur évier bec orientable, aérateur, raccords flexibles M-10 3/8" x 370 mm

	Ref.	€	
ec1	99848	72,00	12
ec3	99340	76,00	12

95231 ec1 95233 ec3 99817 ec1 99543 ec3 99229

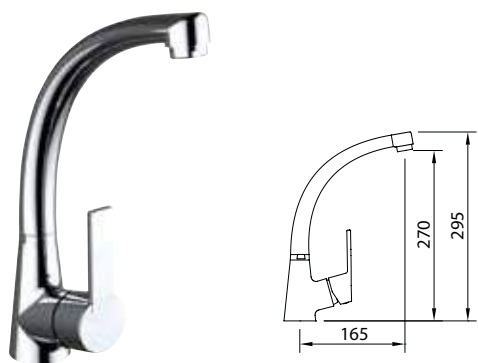

S12 Xtreme 270 mm

FREGADERO
Sink mixer | Mitigeur évier

Mezclador con aireador, caño conformado giratorio, flexibles M-10 3/8" x 370 mm.

Mixer with aerator, swivel tube spout, flexible hoses M-10 3/8" x 370 mm.

Mitigeur évier bec orientable, aérateur, raccords flexibles M-10 3/8" x 370 mm

	Ref.	€	📦
	99833	72,00	12
	99265	76,00	12

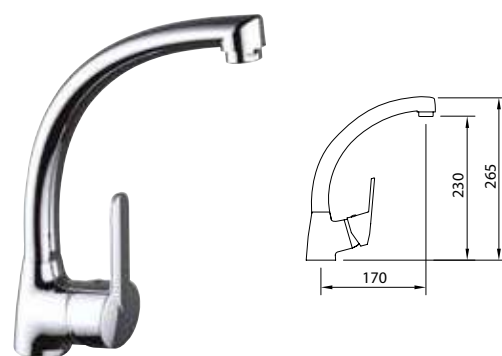
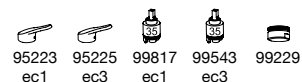

S12 Urban 230 mm

FREGADERO
Sink mixer | Mitigeur évier

Mezclador con aireador, caño conformado giratorio, flexibles M-10 3/8" x 370 mm.

Mixer with aerator, swivel tube spout, flexible hoses M-10 3/8" x 370 mm.

Mitigeur évier bec orientable, aérateur, raccords flexibles M-10 3/8" x 370 mm

	Ref.	€	📦
	98334	72,00	12
	98803	76,00	12

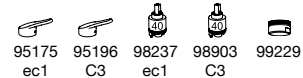

S12 Urban 230 mm

FREGADERO
Sink mixer | Mitigeur évier

Mezclador con aireador, caño fundido giratorio y enlaces de alimentación flexibles M-10 3/8" x 370 mm.

Mixer with aerator, swivel cast spout and connections M10-3/8" x 370 mm.

Mitigeur évier bec orientable, aérateur, raccords flexibles M-10 3/8" x 370 mm

	Ref.	€	📦
	98344	78,00	12
	98804	82,00	12

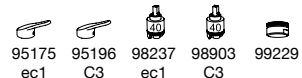



98921

START urban
Fregadero
Sink Mixer
Mitiger évier



monomando horizontal

horizontal single lever | mitigeur horizontal

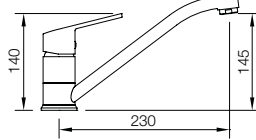

BAHAMA xtreme 145 mm

FREGADERO HORIZONTAL
Horizontal sink mixer | Mitigeur évier

Mezclador con aireador, caño giratorio y flexibles M-10 3/8" x 370 mm.
Mixer, aerator, swivel spout flexible hoses M-10 3/8" x 370 mm.
Mitigeur évier bec orientable, aérateur, raccords flexibles M-10 3/8" x 370 mm

	Ref.	€	📦
	99944	84,00	8
	99945	88,00	8
	98209 98870 C1	98902 60155 C3	97688

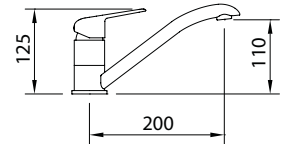

START elegance 110 mm

FREGADERO HORIZONTAL
Horizontal sink mixer | Mitigeur évier

Mezclador con aireador, caño giratorio y flexibles M-10 3/8" x 370 mm.
Sink mixer with aerator, swivel spout, flexible hoses M-10 3/8" x 370 mm.
Mitigeur évier bec orientable, aérateur, raccords flexibles M-10 3/8" x 370 mm

	Ref.	€	📦
	99386	84,00	12
	99388	88,00	12
	95234 ec1	95236 ec3	99540 99542 ec1 ec3
			99229

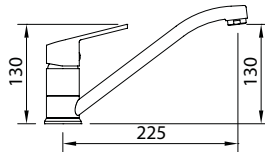

S12 urban 130 mm

FREGADERO HORIZONTAL
Horizontal sink mixer | Mitigeur évier

Mezclador con aireador, caño giratorio y flexibles M-10 3/8" x 370 mm.
Sink mixer, aerator, swivel spout, flexible hoses M-10 3/8" x 370 mm.
Mitigeur évier bec orientable, aérateur, raccords flexibles M-10 3/8" x 370 mm

	Ref.	€	📦
	99221	65,00	12
	99222	67,00	12
	99223	69,00	12
	99224 ec1-ec2	99225 ec3	99226 ec1
			99227 ec2
			99228 ec3
			90025

monomando extraíble

pull out single lever | mitigeur extractible

COCINA

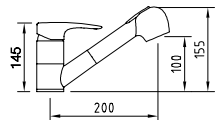

BAHAMA xtreme 100 mm

FREGADERO EXTRAÍBLE

Pull-out sink mixer | Mitigeur évier avec douchette extractible

Mezclador con aireador, caño giratorio, ducha extraíble con pulsador para lavavajillas, enlaces de alimentación flexibles M-10 3/8" x370 mm.
Mixer with aerator, swivel spout, pull-out handset and flexible hoses M-10 3/8" x 370 mm.
Mitigeur évier bec orientable, douchette extractible, aérateur, raccords flexibles M-10 3/8" x 370 mm

	Ref.	€	📦	Incluye Includes
	98180	158,00	8	2 Functions 90794 96117

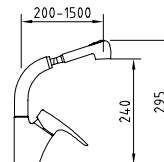

HABANA xtreme 240 mm

FREGADERO EXTRAÍBLE

Pull-out sink mixer | Mitigeur évier avec douchette extractible

Mezclador con aireador, caño giratorio, ducha extraíble con pulsador para lavavajillas, enlaces de alimentación flexibles M-10 3/8" x 370 mm.
Mixer with aerator, swivel spout, pull-out handset and flexible hoses M-10 3/8" x 370 mm.
Mitigeur évier bec orientable, douchette extractible, aérateur, raccords flexibles M-10 3/8" x 370 mm

	Ref.	€	📦	Incluye Includes
	98552	122,00	12	2 Functions 90794 96117

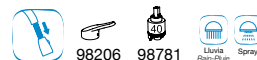

monomando mural

wall mounted single lever | mitigeur mural

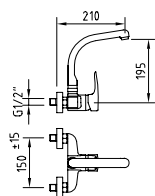

HABANA xtreme 195 mm

FREGADERO MURAL

Wall mounted single lever sink mixer | Mitigeur évier mural

Mezclador con aireador, caño superior conformado giratorio.
Mixer, aerator, upper swivel tube spout
Mitigeur évier mural, bec orientable façonné, aérateur

	Ref.	€	📦
	98549	91,00	12

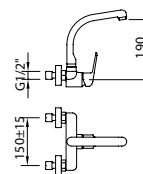

START elegance 190 mm

FREGADERO MURAL

Wall mounted single lever sink mixer | Mitigeur évier mural

Mezclador mural con aireador, caño conformado giratorio superior.
Wall mounted mixer with aerator, upper swivel tube spout.
Mitigeur évier mural, bec orientable façonné, aérateur

	Ref.	€	📦
	99389	93,00	12





PANAM elegance 185 mm

FREGADERO MURAL

Wall mounted single lever sink mixer | Mitigeur évier mural

Mezclador mural con aireador, caño conformado giratorio superior.
Wall mounted mixer with aerator, upper swivel tube spout.
Mitigeur évier mural, bec orientable façonné, aérateur

	Ref.	€	📦
 ec1	96346	88,00	12



PANAM xtreme 195 mm

FREGADERO MURAL

Wall mounted single lever sink mixer | Mitigeur évier mural

Mezclador con aireador, caño conformado giratorio.
Mixer with aerator, swivel tube spout.
Mitigeur évier mural, bec orientable façonné, aérateur

	Ref.	€	📦
 ec1	98766	88,00	12



PANAM xtreme 195 mm

FREGADERO MURAL

Wall mounted single lever sink mixer | Mitigeur évier mural

Mezclador con aireador, caño conformado giratorio.
Mixer with aerator, swivel tube spout.
Mitigeur évier mural, bec orientable façonné, aérateur

	Ref.	€	📦
 ec1	98146	84,00	12





PANAM urban 185 mm

FREGADERO MURAL

Wall mounted single lever sink mixer | Mitigeur évier mural

Mezclador con aireador, caño conformado giratorio.
Mixer with aerator, swivel tube spout.
Mitigeur évier mural, bec orientable façonné, aérateur

	Ref.	€	📦
  ec1	96067	88,00	12



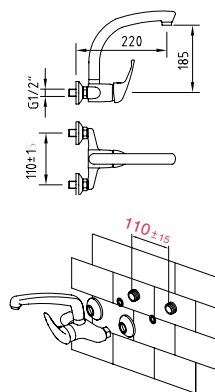

PANAM urban 185 mm

FREGADERO MURAL 110

Wall mounted single lever sink mixer | Mitigeur évier mural

Mezclador con aireador, caño conformado giratorio.
Mixer with aerator, swivel tube spout.
Mitigeur évier mural, bec orientable façonné, aérateur

	Ref.	€	📦
	ec1 98500	88,00	12

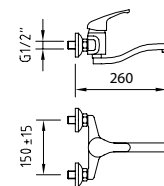

PANAM urban

FREGADERO MURAL

Wall mounted sink mixer | Mitigeur évier mural

Mezclador mural con aireador y caño giratorio inferior.
Wall mounted mixer operated with aerator, flower swivel spout
Mitigeur évier mural, bec orientable façonné, aérateur

	Ref.	€	📦
	ec1 97805	84,00	8

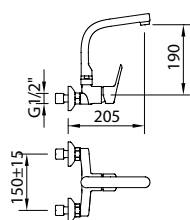

S12 elegance 190 mm

FREGADERO MURAL

Wall mounted single lever sink mixer | Mitigeur évier mural

Mezclador mural con aireador, caño conformado giratorio superior.
Wall mounted mixer with aerator, upper swivel tube spout.
Mitigeur évier mural, bec orientable façonné, aérateur

	Ref.	€	📦
	ec1 99849	88,00	12

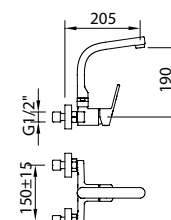

S12 xtreme 190 mm

FREGADERO MURAL

Wall mounted single lever sink mixer | Mitigeur évier mural

Mezclador mural con aireador, caño conformado giratorio superior.
Wall mounted sink mixer with aerator, upper swivel tube spout.
Mitigeur évier mural, bec orientable façonné, aérateur

	Ref.	€	📦
	ec1 99834	88,00	12







S12 urban 195 mm

FREGADERO MURAL

Wall mounted sink mixer | Mitigeur évier mural

Mezclador mural con aireador, caño conformado giratorio superior.
Wall mounted sink mixer with aerator, upper swivel tube spout.
Mitigeur évier mural, bec orientable façonné, aérateur

	Ref.	€	
 	98335	88,00	12



S12 urban 135 mm

FREGADERO MURAL CAÑO LARGO

**Long spout wall mounted sink mixer
Mitigeur évier mural**

Mezclador mural con aireador, caño conformado giratorio superior.
Wall mounted sink mixer with aerator, upper swivel tube spout.
Mitigeur évier mural, bec orientable façonné, aérateur

	Ref.	€	
 ec1	98329	91,00	12



monomando 1 agua

1 water single lever | robinet 1 eau

COCINA

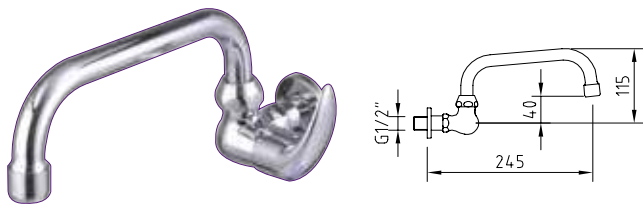

PANAM Xtreme

GRIFO SIMPLE MURAL

Wall mounted single tap | Robinet simple mural

Grifo de pared con aireador y caño conformado giratorio.
Deck mounted single faucet aerator and swivel tube spout.
Robinet évier bec orientable, aérateur.



S12 urban

GRIFO SIMPLE MURAL

Wall mounted single mixer | Robinet simple mural

Grifo simple mural con aireador y caño conformado giratorio.
Wall mounted single tap aerator and swivel tube spout.
Robinet évier bec orientable, aérateur

	Ref.	€	📦
	98459	31,00	12



90026 96208

	Ref.	€	📦
	98450	31,00	12



90026 96208

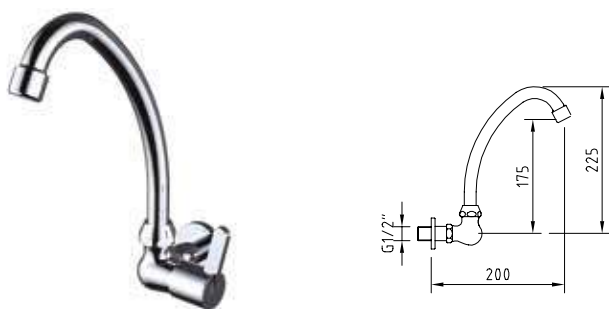

S12 urban

GRIFO SIMPLE MURAL

Wall mounted single mixer | Robinet simple mural

Grifo simple mural con aireador y caño conformado giratorio.
Wall mounted single mixer, aerator and swivel tube spout.
Robinet évier bec orientable, aérateur

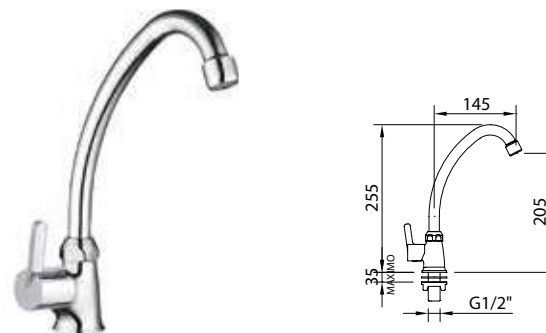

S12 urban

GRIFO SIMPLE REPISA

Single mixer | Robinet simple

Con caño conformado giratorio con aireador.
Swivel tube spout, aerator.
Robinet lavabo, aérateur, 1/2"

	Ref.	€	📦
	98501	31,00	12



90026 96208

	Ref.	€	📦
	98992	31,00	24



90026 96208

bimando vertical

two handle vertical | mélangeur vertical

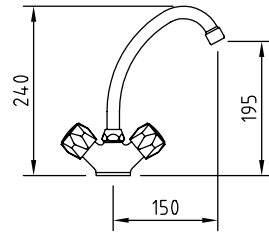

WITH2 guayama 195 mm

FREGADERO

Sink mixer | Mélangeur évier

Mezclador con aireador, caño conformado giratorio, flexibles M-10 3/8" x 370 mm.

Mixer with aerator, swivel tube spout, flexible hoses M-10 3/8" x 370 mm.

Mélangeur évier, bec orientabl, eaérateur, raccords flexibles M-10 3/8" x 370 mm

	Ref.	€	
	96088	48,00	12



96232

96233

96208

90026

bimando mural

wall mounted two handle | mélangeur mural

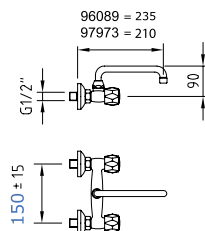

WITH2 guayama 90 mm

FREGADERO MURAL 150MM

Wall mounted single lever sink mixer 150 mm | Mélangeur évier mural 150 mm

Mezclador con aireador, caño conformado giratorio.

Mixer with aerator, swivel tube spout.

Mélangeur évier mural, bec orientable, aérateur

	Ref.	€	
235 mm caño, spout, bec	96089	57,00	8
210 mm caño, spout, bec	97973	57,00	8



96232

96233

96208

90026

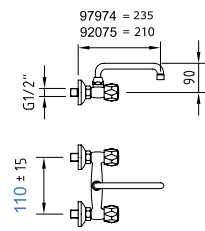

WITH2 guayama 90 mm

FREGADERO MURAL 110MM

Wall mounted single lever sink mixer 110 mm | Mélangeur évier mural 110 mm

Mezclador con aireador, caño conformado giratorio.

Mixer with aerator, swivel tube spout.

Mélangeur évier mural, bec orientable, aérateur

	Ref.	€	
235 mm caño, spout, bec	97974	43,00	12
210 mm caño, spout, bec	92075	43,00	12



96232

96233

94459

90026

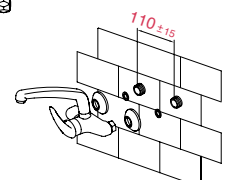

grifo 1 agua

1 water | robinet 1 eau

COCINA

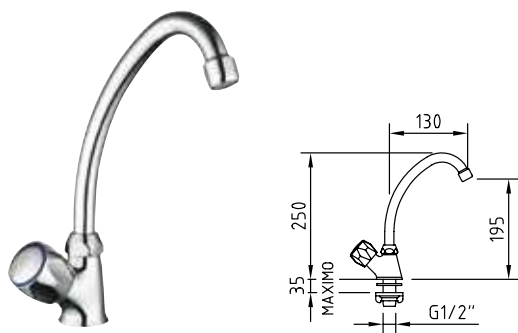

WITH2 guayama 195 mm

GRIFO SIMPLE REPISA

Single tap | Robinet simple

Grifo con aireador y caño conformado giratorio.
Deck mounted single faucet aerator and swivel tube spout.
Robinet évier bec orientable, aérateur

	Ref.	€	📦
	96462	30,00	8



WITH2 guayama 175 mm

GRIFO SIMPLE MURAL

Wall mounted single tap | Robinet simple mural

Grifo de pared con aireador y caño conformado giratorio.
Deck mounted single faucet aerator and swivel tube spout.
Robinet évier bec orientable, aérateur

	Ref.	€	📦
	96754	30,00	12

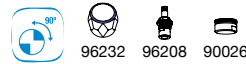

WITH2 guayama 40 mm

GRIFO SIMPLE MURAL

Wall mounted single tap | Robinet simple mural

Grifo de pared con aireador y caño conformado giratorio.
Deck mounted single faucet aerator and swivel tube spout.
Robinet évier bec orientable, aérateur

	Ref.	€	📦
	96767	30,00	12



Gerontológico Medical lever P.M.R.



gerontológico vertical

vertical medical lever | manette médicale vertical

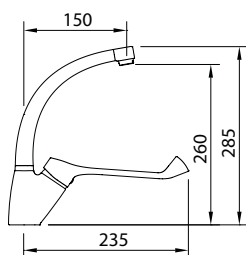

S12 urban

FREGADERO CON MANETA GERONTOLÓGICA

Sink mixer with medical lever | Mitigeur évier avec manette médicale

Fregadero con maneta gerontológica con aireador y caño conformado giratorio y flexibles M-10 3/8" x 370 mm con palanca gerontológica.

Sink mixer with medical lever with mixer, swivel tube spout, with medical lever operated with aerator, flexible hoses M-10 3/8" x 370 mm.

Mitigeur évier, manette médicale, bec orientable façonné, aérateur, raccords flexibles M-10 3/8" x 370 mm

Ref.	€	📦
 99215	82,00	8



99217 98237 90025

gerontológico mural

wall mounted medical lever | manette médicale mural

COCINA

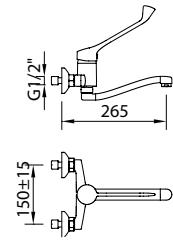
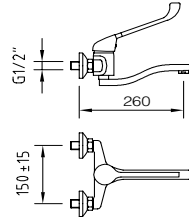

PANAM urban

FREGADERO CON MANETA GERONTOLÓGICA

Wall mounted sink mixer with medical lever | Mitigeur évier mural, manette médicale

Mezclador mural con aireador, con palanca gerontológica y caño giratorio inferior.

Wall mounted mixer with medical lever operated with aerator, flower swivel spout

Mitigeur évier mural, manette médicale, bec orientable façonné, aérateur

	Ref.	€	📦
	ec1 97975	92,00	12



S12 urban

FREGADERO MURAL CON MANETA GERONTOLÓGICA

Wall sink mixer with medical lever | Mitigeur évier mural avec manette médicale

Fregadero con maneta gerontológica mural con aireador, caño giratorio inferior.

Sink mixer with medical lever with mixer, with wall mounted mixer, medical lever operated with aerator, lower swivel spout.

Mitigeur évier mural, manette médicale, bec orientable façonné, aérateur

	Ref.	€	📦
	99216	96,00	12

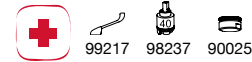

accesorios cocina

kitchen accessories | accessoires de cuisine

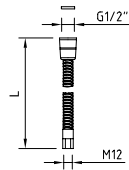

FLEXIBLE NYLON

Nylon flexible | Nylon flexible

Para 96755.
To 96755.
Pour 96755.

Ref.	€	📦
98006	10,50	1

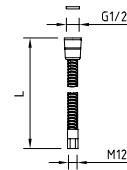

FLEXIBLE

Flexible | Flexible

Tubo flexible para ducha extraíble lavavajillas. Inox
Flexible for pull-out mixer. Stainless steel
Flexible pour évier avec douchette extractible

Ref.	€	📦
96117	13,50	1
99173	15,00	1
96464	9,75	1

Para/To/Pour Artic 98689

Para/To/Pour Artic 97101, 96771, 96365, 96175, 96176





Komeo, central de tratamiento de agua

Water Treatment Unit
Station de traitement de l'eau



Komeo
207



Recambios
Spare parts
Pièces de rechange
207

komeo

Unidad de tratamiento de agua

Water treatment unit | Unité de traitement de l'eau

Innovación en el tratamiento del agua

Water Treatment innovation

Innovation dans le traitement de l'eau

Las mejoras de la unidad de Komeo son el resultado directo de la experiencia en el desarrollo de sistemas de tratamiento de agua de COMAP.

Durante más de 30 años, las soluciones de COMAP han tenido la reputación de cumplir los requisitos más estrictos en términos de calidad del agua.

Toda la gama de productos de tratamiento de agua COMAP está **diseñada, fabricada e inspeccionada en nuestro sitio industrial con certificación ISO 9001 en Montélier, en el sur de Francia.**

The enhancements of the Komeo water treatment unit are the direct result of COMAP Water Treatment expertise in the development of water treatment systems.

For more than 30 years, COMAP Water Treatment solutions have been reputed as meeting the most stringent requirements in terms of water quality.

*The entire COMAP Water Treatment product range is **designed, manufactured and inspected on our ISO 9001-certified industrial site in Montélier in the south of France.***

Les avancées de la centrale de traitement de l'eau Komeo sont directement issues du savoir-faire de COMAP Water Treatment en développement de matériels de traitement d'eau.

Depuis plus de 30 ans, les solutions COMAP Water Treatment sont réputées pour répondre aux exigences les plus rigoureuses en matière de qualité de l'eau.

L'ensemble des produits de la gamme de COMAP Water Treatment est élaboré, fabriqué et contrôlé sur le site industriel certifié ISO 9001 de Montélier dans la Drôme.



Tratamiento profesional en toda la casa

Professional treatment throughout the home

Un traitement professionnel pour tout l'habitat



+ INHIBIDOR DE CAL ELECTRÓNICO

- Protege las tuberías y los electrodomésticos de la incrustación

ELECTRONIC DESCALING

- Protects pipes and household electrical appliances from scaling

ANTITARTRE ÉLECTRONIQUE

- Protège du tartre les canalisations et les appareils électroménagers

+ DOS FILTROS DE CARBONO

- Filtra plaguicidas y herbicidas
- Trata metales pesados y manganeso
- Reduce el contenido de nitrato
- Elimina el mal sabor del cloro

TWO ACTIVATED CARBON FILTERS

- Filter out pesticides and herbicides
- Treat heavy metals and manganese
- Reduce nitrate content
- Remove the bad taste of chlorine

DOUBLE FILTRATION "CHARBON ACTIF"

- Filtre les pesticides et herbicides
- Traite les métaux lourds et le manganèse
- Réduit la présence des nitrates
- Supprime le mauvais goût de chlore

+ SENSORES DE SEGURIDAD

- Detecta fugas y exceso de presión, y corta automáticamente la red si es necesario

SAFETY SENSORS

- Detect leaks and excess pressure, and automatically cut off the network if necessary

CAPTEURS DE SÉCURITÉ

- Détecent les fuites, les surpressions et coupent automatiquement le réseau au besoin

+ PREFILTRO DE AUTO LIMPIEZA

- Atrapa sedimentos y partículas suspendidas en el agua.
- Purga automática, sin quitar el cartucho. Se puede activar a distancia a través de la válvula de potencia.

SELF-CLEANING PREFILTER

- Traps sediment and particles suspended in the water.
- Automatic purge, without removing the cartridge. Can be remotely activated through the power-valve.

PRÉFILTRE AUTONETTOYANT

- Retient les sédiments et particules en suspension dans l'eau.
- Purge automatiquement sans démontage des cartouches, déclenchable à distance grâce à la vanne motorisée.

+ PANTALLA TÁCTIL INTERACTIVA

- Información en tiempo real: consumo de agua, estado de desgaste de los consumibles, mal funcionamiento, etc.
- Puede ser controlado desde una tableta o teléfono inteligente.

INTERACTIVE TOUCH SCREEN

- Real time information: water consumption, wear status of consumables, malfunctions, etc.
- Can be controlled from a tablet or smartphone

ÉCRAN TACTILE ET INTERACTIF

- Informe en temps réel: consommation d'eau, usure des consommables, dysfonctionnements ...
- Pilotable avec une tablette ou un smartphone.



+ LÁMPARA UVC

- Neutraliza bacterias, virus, moho y fermentación, y previene el desarrollo de legionella en redes de agua.

UVC LAMP

- Neutralises bacteria, viruses, mould and fermentation, and prevents the development of legionella in water networks.

LAMPE UVC

- Neutralise les bactéries, virus, moisissures, levures et prévient le développement de légionelles dans le réseau d'eau.

Ecología Medio ambiente

Ecology. Environment / Écologie. Environnement

Komeo es una solución ecológica, **sin tratamiento químico ni rechazo de sal.**

A diferencia de los suavizantes, Komeo no desperdicia agua a través de los ciclos de regeneración.

*Komeo is an environmentally-friendly solution, **with no chemical treatment or salt rejection.** Unlike softeners, Komeo does not waste any water through regeneration cycles.*

*Komeo respecte l'environnement en **s'affranchissant de tout traitement chimique et de tout rejet de sel.** Contrairement aux adoucisseurs, Komeo évite tout gaspillage d'eau lié aux cycles de régénération.*

LA ALTERNATIVA PARA COMPRAR AGUA EMBOTELLADA:

- **Ahorre casi 2000 botellas por año**, para una familia de 4 personas, cada una bebiendo un promedio de 2 litros de agua por día.
- **Sin transporte, sin embalaje.**

THE ALTERNATIVE TO PURCHASING BOTTLED WATER:

- **Save almost 2,000 bottles per year**, for a family of 4 people, each drinking an average of 2 litres of water per day.
- **No transport, no packaging.**

L'ALTERNATIVE À L'ACHAT D'EAU MINÉRALE:

- **Près de 2 000 bouteilles économisées par an**, pour une famille de 4 personnes buvant chacune en moyenne 2 litres d'eau / jour.
- **Pas de transport, pas d'emballage.**

KOMEO DETECTA FUGAS

- Las fugas representan del 15 al 20% del consumo anual de agua en el hogar.
- Un grifo que gotea representa de 4 a 5 litros por hora, es decir, 35 a 44 m³ / año.

KOMEO DETECTS LEAKS

- Leaks represent 15 to 20% of annual household water consumption
- A dripping tap represents 4 to 5 litres per hour, i.e. 35 to 44 m³ / year

KOMEO DÉTECTE LES FUITES

- Les fuites dans l'habitat représentent 15 à 20% de l'eau consommée en moyenne par an.
- Un robinet qui fuit goutte-à-goutte représente 4 à 5 litres/heure, soit 35 à 44 m³ / an.

DID YOU KNOW?

NEW

KOMEO



CENTRAL DE TRATAMIENTO DE AGUA
Water treatment unit | unité de traitement de l'eau

Ref.	€	📦
C75236	3.345,00	1



MALLA PREFILTRO
Prefilter mesh | Tamis pour préfiltre

Ref.	€	📦
C75237	11,80	1



CARTUCHO KDF
KDF Cartridge | Cartouche KDF

Ref.	€	📦
C75238	78,20	1



LÁMPARA 25 W UVc
Lamp 25 W UVc | Lampe 25 W UVc

Ref.	€	📦
C75239	79,00	1

Conectado

Connected/Connectée



- La aplicación Komeo para tabletas y teléfonos inteligentes **permite monitorear el consumo de agua en tiempo real.**
- Komeo se puede configurar de forma remota a través de su red Wi-Fi.
- **Se le informa automáticamente** de cualquier mal funcionamiento del sistema (estado de desgaste de los consumibles, fugas, exceso de presión, etc).



- *The Komeo application for tablet and smartphone allows **water consumption to be monitored in real time.***
- *Komeo can be configured remotely through your Wi-Fi network.*
- ***You are automatically informed of** any system malfunction (wear status of consumables, leaks, excess pressure, etc).*
- *L'application Komeo pour tablette et smartphone vous permet de **suivre votre consommation d'eau en temps réel.***
- *Le réglage de Komeo est possible à distance via votre réseau Wi-Fi.*
- ***Vous êtes informé automatiquement** d'éventuels dysfonctionnements sur votre réseau (état d'usure des consommables, fuites, surpressions ...).*





COLECTIVIDADES

Clever para espacios colectivos

Clever for collective spaces
Clever pour les collectivités



Temporizados
Delay action
Temporisés
210



Ducha higiénica
Shattaf
Douche hygiénique
211



Grifos individuales
Cold water taps
Robinets individuels
213



Maneta gerontológica
Medical lever
P.M.R.
215

Temporizados

Delay action
Temporisés

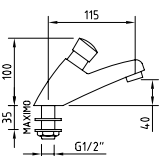

GRIFERIA TEMPORIZADA Delay action basin tap | Robinet temporisé

Grifo de repisa para lavabo, con aireador, 14 segundos, cartucho M26
Deck mounted basin tap, with aerator, 14 seconds, cartridge M26
Robinet simple, avec aérateur, 14 secondes cartouche M26

Ref.	€	📦
96127	53,00	24

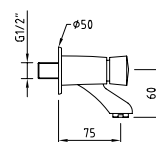

GRIFERIA TEMPORIZADA MURAL Wall mounted delay action basin tap | Robinet temporisé mural

Grifo mural para lavabo, con aireador, 14 segundos, cartucho M26
Wall mounted basin tap, with aerator, 14 seconds, cartridge M26
Robinet simple, avec aérateur, 14 secondes cartouche M26

Ref.	€	📦
96128	41,00	24

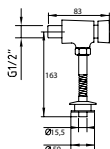

GRIFERIA TEMPORIZADA URINARIO MURAL Wall mounted urinal flush valve Robinet temporisé urinoir mural

Grifo mural de 1/2" para urinario, 7 segundos, cartucho M26.
Urinal 1/2", 7 seconds, cartridge M26.
Robinet temporisé urinoir 1/2", 7 secondes, cartouche M26.

Ref.	€	📦
92801	43,00	24

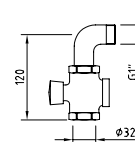

GRIFERIA TEMPORIZADA SANITARIO MURAL Wall mounted sanitary flush valve Robinet temporisé sanitaire mural

Fluxor exterior para urinario.
Urinal external fluxor.
Robinet temporisé urinoir mural.

Ref.	€	📦
96152	64,00	24



Ducha higiénica Shattaf Douche hygiénique

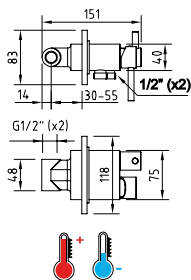
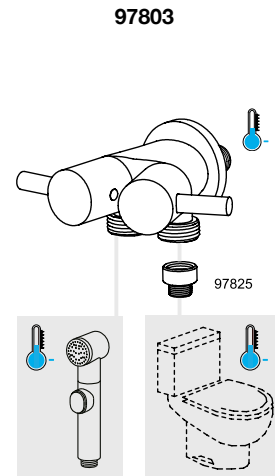
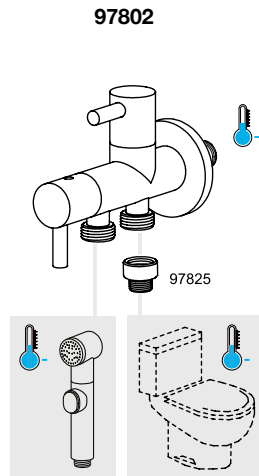
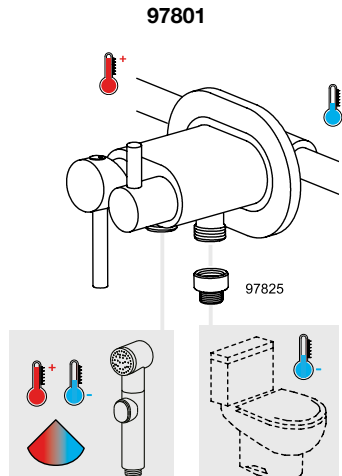
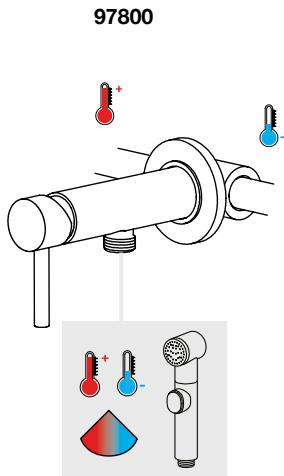

SHATTAF TOUAREG

Mezclador empotrado para ducha higiénica con salida cisterna.
Wall mounted single mixer shattaf with water tank outlet.
Mitigeur mural pour douchette hygiénique et sortie réservoir de chasse d'eau

Ref.	€	Q
97801	110,00	6

Incluye Includes Inklus

- 96136 1,20m Inox
- 97822 97823 97824
- 1/2" F-3/8" M 97825 98988

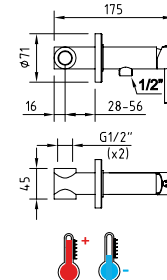

SHATTAF ATLAS

Mezclador empotrado para ducha higiénica.
Wall mounted single mixer shattaf.
Mitigeur mural pour douchette hygiénique

Ref.	€	Q
97800	83,00	6

Incluye Includes Inklus

- 96136 1,20m Inox
- 97822 97824
- 98988

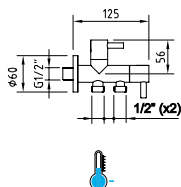

SHATTAF CAMEL

Válvula para ducha higiénica con salida cisterna.
Shattaf bidet spray with water tank outlet.
Robinet pour douchette hygiénique et sortie réservoir de chasse d'eau

Ref.	€	Q
97802	62,00	6

Incluye Includes Inklus

- 96136 1,20m Inox
- 97823
- 1/2" F-3/8" M 97825 98988

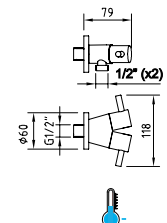

SHATTAF OASIS

Válvula para ducha higiénica con salida cisterna.
Shattaf bidet spray with water tank outlet.
Robinet pour douchette hygiénique et sortie réservoir de chasse d'eau

Ref.	€	Q
97803	57,00	6

Incluye Includes Inklus

- 96136 1,20m Inox
- 97823
- 1/2" F-3/8" M 97825 98988



SHATTAF SAHARA

Válvula para ducha higiénica con soporte integrado.
Shattaf with support included.
Robinet pour douchette hygiénique avec support intégré

Ref.	€	📦
98442	50,00	10

Incluye Includes Inklus

 96136 1,20m Inox



SHATTAF KIRA

Ducha higiénica latón.
Brass hygienic handshower
Douchette hygiénique laiton

Ref.	€	📦
98799	35,00	50

Incluye Includes Inklus

 98988 1,20m Inox 97816

Disponible a partir de Marzo 2018
 Available from March 2018 | Disponible à partir de Mars 2018



SHATTAF NINA

Ducha higiénica latón.
Brass hygienic handshower
Douchette hygiénique laiton

Ref.	€	📦
98798	33,00	50

Incluye Includes Inklus

 98988 1,20m Inox 97816



HIGIÉNICA

Hygienic handshower / Douchette hygiénique

Ducha higiénica, ABS.
Hygienic handshower , ABS.
Douchette hygiénique ,ABS.

Ref.	€	📦
96136	24,00	20

Incluye Includes Inklus

 98988 1,20m Inox 97816



SAHEL HIGIÉNICA

Hygienic handshower / Douchette hygiénique

Ducha higiénica, ABS.
Hygienic handshower , ABS.
Douchette hygiénique ,ABS.

Ref.	€	📦
97809	15,50	20

Incluye Includes Inklus

 98988 1,20m Inox 97816



HIGIÉNICA

Hygienic handshower / Douchette hygiénique

Ducha higiénica, ABS.
Hygienic handshower , ABS.
Douchette hygiénique ,ABS.

Ref.	€	📦
97740	27,00	50

Incluye Includes Inklus

 98988 1,50m plastificado

Grifos individuales

Cold water taps
Lave-main

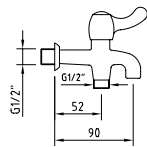

GRIFERÍA DE FREGADERO Y LAVADERO DE PARED Wall mounted sink and washing-machine tap Lave-main

Grifo de pared salida fregadero / lavadero / lavadora.
Wall mounted single tap.
Robinet, aérateur

Ref.	€	📦
96132	32,00	24



96234

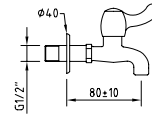

GRIFERÍA DE FREGADERO Y LAVADERO Sink and washing-machine tap | Lave-main

Grifo de pared
Wall mounted single tap.
Robinet, aérateur

Ref.	€	📦
96131	18,00	48

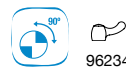

96234

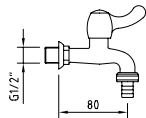

GRIFERÍA DE FREGADERO Y LAVADERO Sink and washing-machine tap Lave-main

Grifo de pared
Wall mounted single tap.
Robinet, aérateur

Ref.	€	📦
96133	16,00	96



96234

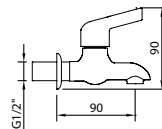

START elegance

GRIFO SIMPLE DE PARED Single washbain wall tap Lave-main

Grifo mural con aireador.
Wall single basin tap, with aerator.
Robinet, aérateur

Ref.	€	📦
ACS 99393	26,00	12



96202 96208

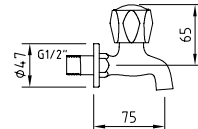

WITH2 guayama

GRIFERÍA SIMPLE MURAL Wall mounted single tap Robinet simple mural

Grifo mural con aireador, índice de agua fría.
Wall mounted single basin faucet, with aerator, cold water index.
Robinet, aérateur

Ref.	€	📦
ACS 98451	27,00	72



96232 96208

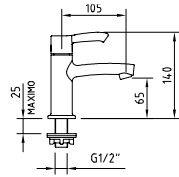

GRIFO SIMPLE PARA LAVABO
Single washbain tap | Lave-main

Grifo de repisa con aireador.
Deck mounted single basin tap, with aerator.
Robinet, aérateur

Ref.	€	📦
98448	58,00	10

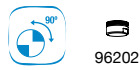

96202

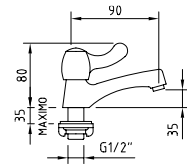

GRIFO SIMPLE PARA LAVABO
Single washbain tap | Lave-main

Grifo de repisa con aireador.
Deck mounted single basin tap, with aerator.
Robinet, aérateur

Ref.	€	📦
96134	31,00	24



96234 90025

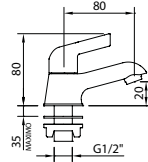

START elegance

GRIFO SIMPLE PARA LAVABO
Single washbain tap | Lave-main

Grifo de repisa con aireador.
Deck mounted single basin tap, with aerator.
Robinet, aérateur

Ref.	€	📦
ACS 99392	33,00	12



96202 96208

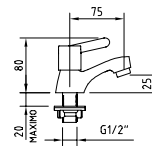

S12 urban

GRIFO SIMPLE PARA LAVABO
Single washbain tap | Lave-main

Grifo de repisa con aireador.
Deck mounted single basin tap, with aerator.
Robinet, aérateur

Ref.	€	📦
98449	26,00	24



96202 96208

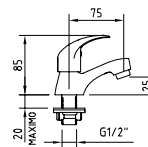

PANAM xtreme

GRIFO SIMPLE PARA LAVABO
Single washbain tap | Lave-main

Grifo de repisa con aireador.
Deck mounted single basin tap, with aerator.
Robinet, aérateur

Ref.	€	📦
98458	26,00	48

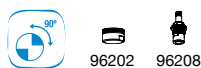

96202 96208

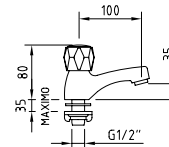

WITH2 guayama

GRIFERÍA SIMPLE REPISA 35
Single tap 35 | Robinet simple 35

Grifo de repisa, con aireador, indice de agua fria.
Deck mounted single basin faucet, with aerator, cold water indice.
Robinet, aérateur

Ref.	€	📦
ACS 96097	26,00	24



96232 96208 90025

Maneta gerontológica Medical lever operated P.M.R.

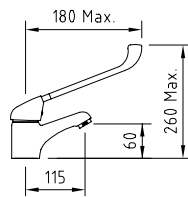

PANAM **urban**

LAVABO CON MANETA GERONTOLÓGICA
Basin mixer with medical lever
Mitigeur lavabo avec manette médicale

Mezclador con aireador, con palanca gerontológica y flexibles M-10 3/8" x 370 mm.
Mixer with medical lever operated with aerator, flexible hoses M-10 3/8" x 370 mm.
Mitigeur lavabo, manette médicale, aérateur, raccords flexibles M-10 3/8" x 370 mm

	Ref.	€	📦
	94694	59,00	12

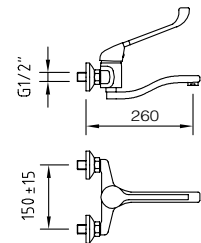
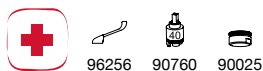

PANAM **urban**

FREGADERO MURAL CON MANETA GERONTOLÓGICA
Wall mounted sink mixer with medical lever
Mitigeur évier mural, avec manette médicale

Mezclador mural con aireador, con palanca gerontológica y caño giratorio inferior.
Wall mounted mixer with medical lever operated with aerator, flower swivel spout
Mitigeur évier mural, manette médicale, bec orientable façonné, aérateur

	Ref.	€	📦
	97975	92,00	8

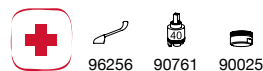

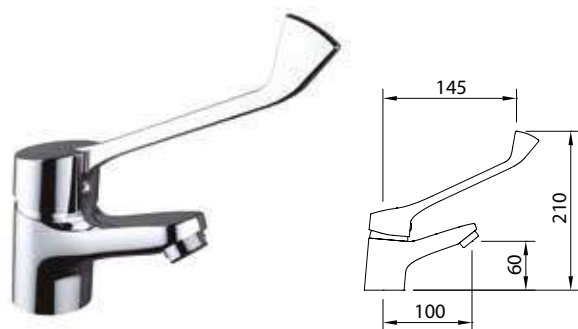

S12 urban

LAVABO CON MANETA GERONTOLÓGICA
Basin mixer with medical lever
Mitigeur lavabo avec manette médicale

Mezclador con aireador, con palanca gerontológica y flexibles M-10 3/8" x 370 mm.
 Mixer with medical lever operated with aerator, flexible hoses M-10 3/8" x 370 mm.
 Mitigeur lavabo, manette médicale, aérateur, raccords flexibles M-10 3/8" x 370 mm

	Ref.	€	📦
	99214	59,00	8

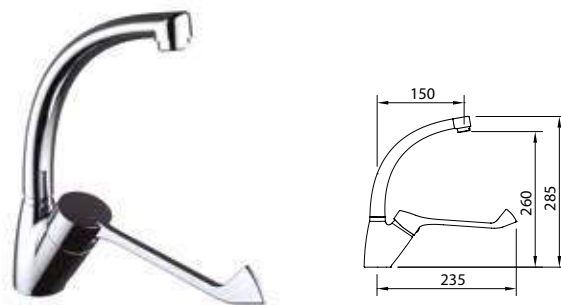
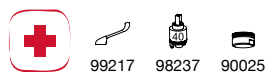

S12 urban

FREGADERO CON MANETA GERONTOLÓGICA
Wall mounted sink mixer with medical lever
Mitigeur évier mural, avec manette médicale

Fregadero con maneta gerontológica con mezclador con aireador y flexibles M-10 3/8" x 370 mm con palanca gerontológica.
 Sink mixer with medical lever with mixer, with medical lever operated with aerator, flexible hoses M-10 3/8" x 370 mm.
 Mitigeur évier, manette médicale, bec orientable façonné, aérateur, raccords flexibles M-10 3/8" x 370 mm

	Ref.	€	📦
	99215	82,00	8

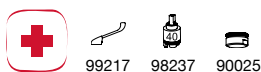

S12 urban

FREGADERO MURAL CON MANETA GERONTOLÓGICA
Wall mounted sink mixer with medical lever
Mitigeur évier mural avec manette médicale

Mezclador mural con aireador, con palanca gerontológica y caño giratorio inferior.
 Wall mounted mixer with medical lever operated with aerator, flower swivel spout
 Mitigeur évier mural, manette médicale, bec orientable façonné, aérateur

	Ref.	€	📦
	99216	96,00	12

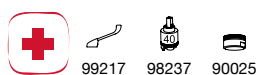

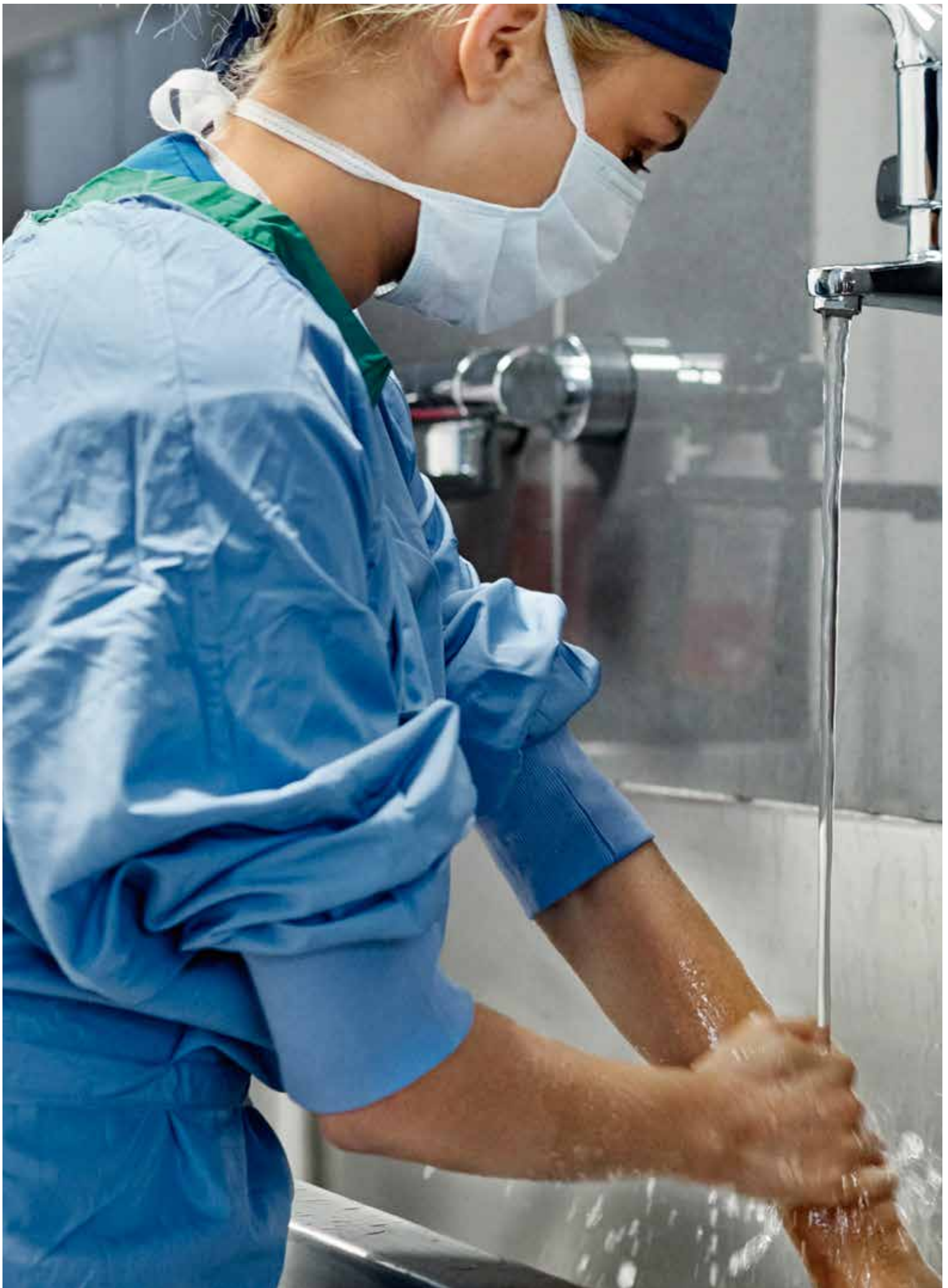



TERMOSTÁTICOS

Clever en tu sala de baño

**Clever in your bathroom
Clever dans votre salle de bain**



Termostáticos
Thermostatics
Termostatiques
220

Termostáticos

Thermostatics
Thermostatiques

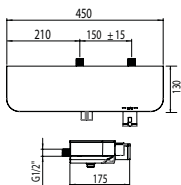

NINE elegance

DUCHA TERMOSTÁTICA
Thermostatic shower mixer
Mitigeur douche thermostatique

Incluye teléfono ducha, flexo y soporte
Includes handset, hose and holder
Inclus douchette, flexible et support
(99611, 98880, 60311)

Ref.	€	📦
60154	370,00	4

Más información More information Plus d'informations Pág. 43

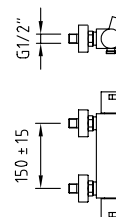

BIMINI

DUCHA TERMOSTÁTICA
Thermostatic Shower mixer | Douche thermostatique

Incluye teléfono ducha, flexo y soporte
Includes handset, hose and holder
Inclus douchette, flexible et support
(96412, 97114, 97112)

Ref.	€	📦
96490	333,00	6

Sin kit ducha
Without shower kit
Sans kit de douche

	98153	303,00	6
--	-------	--------	---

Más información More information Plus d'informations Pág. 31

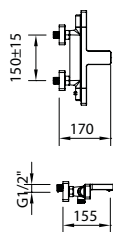

NINE Xtreme

BAÑO-DUCHA TERMOSTÁTICO
Thermostatic bath-shower mixer | Mitigeur bain-douche
thermostatique

Incluye teléfono ducha, flexo y soporte
Includes handset, hose and holder
Inclus douchette, flexible et support
(98880-99609-60311)

Ref.	€	📦
60131	330,00	6

Sin kit ducha
Without shower kit
Sans kit de douche

60132	300,00	6
-------	--------	---

Inversor incorporado en la maneta de caudal
Integral diverter in the flow handle
Inverseur intégré dans la poignée

Más información More information Plus d'informations Pág. 45

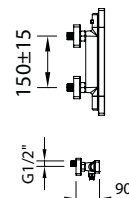

NINE Xtreme

DUCHA TERMOSTÁTICA
Thermostatic shower mixer | Mitigeur douche
thermostatique

Incluye teléfono ducha, flexo y soporte
Includes handset, hose and holder
Inclus douchette, flexible et support
(98880-99609-60311)

Ref.	€	📦
60133	280,00	6

Sin kit ducha
Without shower kit
Sans kit de douche

60134	250,00	6
-------	--------	---

Más información More information Plus d'informations Pág. 45

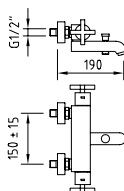

WITH2 morea

BAÑO-DUCHA TERMOSTÁTICO
Thermostatic bath-shower mixer | Mitigeur bain-douche
thermostatique

Incluye teléfono ducha, flexo y soporte
Includes handset, hose and holder
Inclus douchette, flexible et support
(90796, 97114, 97113)

Ref.	€	📦
97012	407,00	8

Sin kit ducha
Without shower kit
Sans kit de douche

	98158	387,00	8
--	-------	--------	---

Más información More information Plus d'informations Pág. 70



WITH2 morea

DUCHA TERMOSTÁTICA
Thermostatic shower mixer | Mitigeur douche
thermostatique

Incluye teléfono ducha, flexo y soporte
Includes handset, hose and holder
Inclus douchette, flexible et support
(90796, 97114, 97113)

Ref.	€	📦
97013	348,00	8

Sin kit ducha
Without shower kit
Sans kit de douche

	98159	328,00	8
--	-------	--------	---

Más información More information Plus d'informations Pág. 70

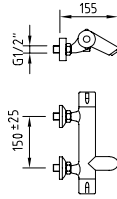

NINE urban

BAÑO-DUCHA TERMOSTÁTICO

Thermostatic bath-shower mixer | Mitigeur bain-douche thermostatique

Incluye teléfono ducha, flexo y soporte
Includes handset, hose and holder
Inclus douchette, flexible et support
(96108, 97670, 98208)

Sin kit ducha
Without shower kit
Sans kit de douche

Ref.	€	
98823	211,00	6
98929	196,00	6

Inversor incorporado en la maneta de caudal
Integral diverter in the flow handle
Inverseur intégré dans la poignée

Más información More information Plus d'informations Pág. 106

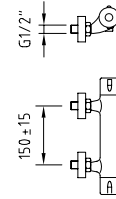
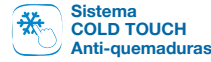

NINE urban

DUCHA TERMOSTÁTICA

Thermostatic shower mixer | Mitigeur douche thermostatique

Incluye teléfono ducha, flexo y soporte
Includes handset, hose and holder
Inclus douchette, flexible et support
(96108, 97670, 98208)

Sin kit ducha
Without shower kit
Sans kit de douche

Ref.	€	
98478	178,00	6
98149	163,00	6

Más información More information Plus d'informations Pág. 106

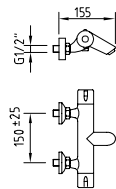

NINE urban

BAÑO-DUCHA TERMOSTÁTICO

Thermostatic bath-shower mixer
Mitigeur bain-douche thermostatique

Incluye teléfono ducha, flexo y soporte
Includes handset, hose and holder
Inclus douchette, flexible et support
(96108, 97670, 90011)

Sin kit ducha
Without shower set
Sans kit de douche

Ref.	€	
98822	196,00	6
98928	181,00	6

Inversor incorporado en la maneta de caudal
Integral diverter in the flow handle
Inverseur intégré dans la poignée

Más información More information Plus d'informations Pág. 105

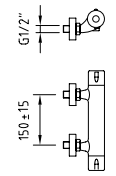

NINE urban

DUCHA TERMOSTÁTICA

Thermostatic shower mixer | Mitigeur douche thermostatique

Incluye teléfono ducha, flexo y soporte
Includes handset, hose and holder
Inclus douchette, flexible et support
(96108, 97670, 90011)

Sin kit ducha
Without shower set
Sans kit de douche

Ref.	€	
97676	163,00	-
60325	163,00	-
97692	148,00	-
60326	148,00	-

Más información More information Plus d'informations Pág. 105

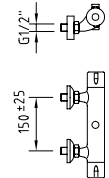

NINE urban

GRIFERÍA PARA DUCHA TUBO EXTENSIBLE

Shower mixer for adjustable shower bar
Mitigeur douche thermostatique double sortie

Sin kit ducha
Without shower set
Sans kit de douche

Ref.	€	
98763	168,00	6

Inversor incorporado en la maneta de caudal
Integral diverter in the flow handle
Inverseur intégré dans la poignée

Más información More information Plus d'informations Pág. 107

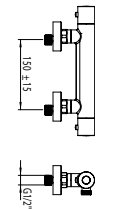

NINE URBAN SLIM

DUCHA TERMOSTÁTICA

Thermostatic shower mixer
Mitigeur douche thermostatique

Incluye teléfono ducha, flexo y soporte
Includes handset, hose and holder
Inclus douchette, flexible et support
(98342, 98342, 97670)

Sin kit ducha
Without shower set
Sans kit de douche

Ref.	€	
60414	153,00	6
60415	138,00	6

Más información More information Plus d'informations Pág. 104



Termostáticos extensibles
Adjustable thermostatics
Thermostatiques extensibles
226

Sistemas de ducha y baño- ducha

Shower and bath-shower systems
Colonnes douche et bain-douche



Termostáticos no extensibles
Non-adjustable thermostatics
Thermostatiques non extensibles
228



Monomandos extensibles
Adjustable single lever
Mitigeurs extensibles
230



Bimandos extensibles
Adjustable two handles
Mélangeurs extensibles
231

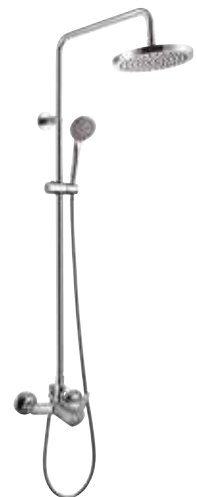

Monomandos no extensibles
Non-adjustable single lever
Mitigeurs non extensibles
231

Sistemas de ducha y baño ducha

Shower and bath-shower systems

Colonne douche et bain-douche



NINE elegance

Termostáticos extensibles
Adjustable thermostatics
Thermostatiques extensibles



NINE Xtreme



NINE urban 

Sistemas de ducha y baño-ducha

Shower and bath-shower systems
Colonne douche et bain-douche

TERMOSTÁTICOS EXTENSIBLES

ADJUSTABLE THERMOSTATICS / THERMOSTATIQUES EXTENSIBLES

BIMINI

CONJUNTO DE BAÑO-DUCHA TERMOSTÁTICO EXTENSIBLE

Extensible Thermostatic bath-shower system
Colonne thermostatique bain-douche extensible

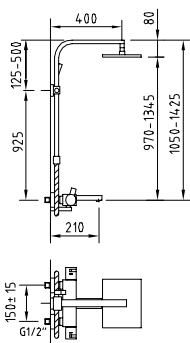

Incluye
Includes
Inclus



Ref.	€	
97057	1.200,00	3

Inversor incorporado en la maneta de caudal
Diverter built in the flow handle
Inverseur intégré dans la poignée

Más información Pág. 33
More information / Plus d'informations

BIMINI

CONJUNTO DE DUCHA TERMOSTÁTICO EXTENSIBLE

Extensible Thermostatic shower system
Colonne thermostatique douche extensible

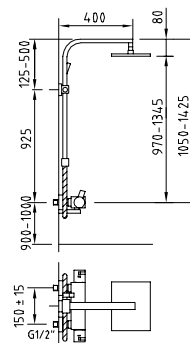

Incluye
Includes
Inclus

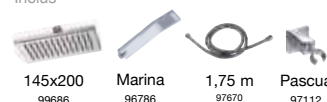

Ref.	€	
97058	1.032,00	3

Más información Pág. 33
More information / Plus d'informations

NINE elegance

CONJUNTO DE DUCHA EXTENSIBLE TERMOSTÁTICO

Thermostatic Extensible shower system
Colonne mélangeur douche extensible thermostatique

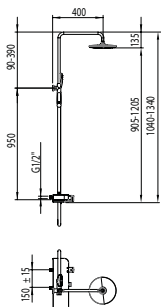

Incluye
Includes
Inclus



Ref.	€	
99731	575,00	4

Inversor incorporado en la maneta de caudal
Diverter built in the flow handle
Inverseur intégré dans la poignée

Más información Pág. 42
More information / Plus d'informations

NINE xtreme

CONJUNTO DE DUCHA EXTENSIBLE TERMOSTÁTICO

Thermostatic Extensible shower system
Colonne mélangeur douche extensible thermostatique

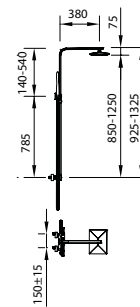

Incluye
Includes
Inclus



Ref.	€	
60135	495,00	4

Inversor incorporado en la maneta de caudal
Diverter built in the flow handle
Inverseur intégré dans la poignée

Más información Pág. 44
More information / Plus d'informations

TERMOSTÁTICOS EXTENSIBLES
ADJUSTABLE THERMOSTATICS / THERMOSTATIQUES EXTENSIBLES

NINE urban

CONJUNTO DE BAÑO-DUCHA TERMOSTÁTICO
Thermostatic bath-shower system
Colonne thermostatique bain-douche extensible

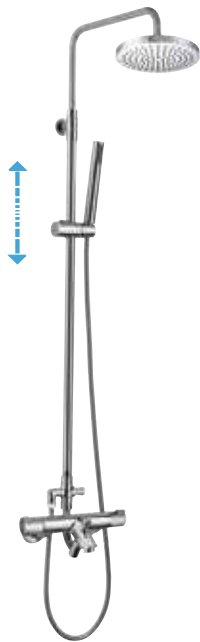

Incluye
Includes
Inclus



Ref.	€	U
98640	450,00	4

Más información Pág. 109
More information / Plus d'informations

NINE urban

CONJUNTO DE DUCHA TERMOSTÁTICO
Thermostatic shower system
Colonne thermostatique douche extensible



Incluye
Includes
Inclus



Ref.	€	U
98761	416,00	4
60327	416,00	-

Más información Pág. 107
More information / Plus d'informations

Código Aenor. Disponible a partir de Mayo 2018
Aenor code. Available from May 2018
Code Aenor. Disponible à partir de Mai 2018

WITH2 antigona

CONJUNTO DE DUCHA TERMOSTÁTICO EXTENSIBLE
Extensible Thermostatic shower system
Colonne thermostatique douche extensible



Incluye
Includes
Inclus



Ref.	€	U
96746	557,00	3

Más información Pág. 66
More information / Plus d'informations

CIRCULAR THERM BOX

CONJUNTO DE DUCHA TERMOSTÁTICO EXTENSIBLE
Adjustable thermostatic shower system
Colonne thermostatique douche extensible



Incluye
Includes
Inclus



*(Pack indivisible de 4 unidades)
(Indivisible packaging of 4 units)
(Pack indivisible de 4 unités)

Ref.	€	U
98762	406,00	4*
60412	406,00	1

Más información Pág. 153
More information / Plus d'informations

Código Aenor. Disponible a partir de Mayo 2018
Aenor code. Available from May 2018
Code Aenor. Disponible à partir de Mai 2018

Sistemas de ducha y baño-ducha

Shower and bath-shower systems
Colonne douche et bain-douche

TERMOSTÁTICOS NO EXTENSIBLES

NON-ADJUSTABLE THERMOSTATICS / THERMOSTATIQUES NON EXTENSIBLES

CAIMAN elegance

CONJUNTO DE DUCHA TERMOSTÁTICO 4 JETS

Thermostatic shower system 4 jets

Colonne thermostatique douche hydromassage

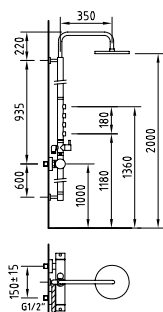

Incluye
Includes
Inclus



Ø200
99637



Caiman
90796



1,80 m
97114

Ref.	€	📦
96436	1075,00	4

Más información Pág. 58
More information / Plus d'informations

WITH2 morea

CONJUNTO DE DUCHA TERMOSTÁTICO 4 JETS

Thermostatic shower system 4 jets

Colonne thermostatique douche hydromassage

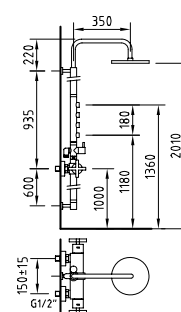

Incluye
Includes
Inclus



Ø200
97109



Caiman
90796



1,80 m
97114

Ref.	€	📦
97018	1.075,00	4

Más información Pág. 71
More information / Plus d'informations

KUADRAT THERM BOX

CONJUNTO DE DUCHA TERMOSTÁTICO

Thermostatic shower system

Colonne thermostatique douche

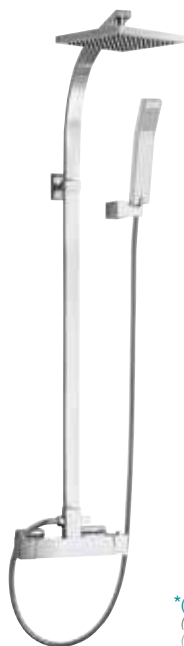

Incluye
Includes
Inclus



Kube
98672



Marina
96786



1,75 m
97670



Saona
96413

Ref.	€	📦
98671	575,00	4*

*Pack indivisible de 4 unidades)
(Indivisible packaging of 4 units)
(Pack indivisible de 4 unités)

Más información Pág. 152
More information / Plus d'informations

CIRCULAR THERM BOX

CONJUNTO DE DUCHA TERMOSTÁTICO

Thermostatic shower system

Colonne thermostatique douche



Incluye
Includes
Inclus



Circular
98518



Syvari 3F
98884



1,75 m
97670



ø20
98997



Support
98998

Inversor incorporado en la maneta de caudal
Diverter built in the flow handle
Inverseur intégré dans la poignée

Ref.	€	📦
98995	376,00	4*
60413	376,00	1

*Pack indivisible de 4 unidades)
(Indivisible packaging of 4 units)(Pack indivisible de 4 unités)

Más información Pág. 153
More information / Plus d'informations

NEW Disponible a partir de
Mayo 2018
Available from May 2018
Disponible à partir de Mai 2018

NINE urban

CONJUNTO DE DUCHA TERMOSTÁTICO
Thermostatic shower system
Colonne thermostatique douche

NEW

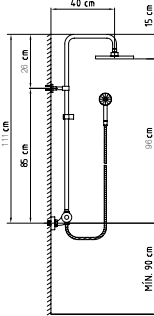

Incluye
Includes
Inclus



Circular
98518



ø20
98997



Syvari 3F
98884



Support
98998



1,75 m
97670

Inversor incorporado en la maneta de caudal
Diverter built in the flow handle
Inverseur intégré dans la poignée

Ref.	€	
60328	386,00	1

Disponibile a partir de Mayo 2018
Available from May 2018
Disponible à partir de Mai 2018

Más información Pág. 108
More information / Plus d'informations

MONOMANDOS EXTENSIBLES

ADJUSTABLE SINGLE LEVERS / MITIGEURS EXTENSIBLES

BIMINI

CONJUNTO BAÑO-DUCHA EXTENSIBLE
Extensible bath-shower system
Colonne mitigeur bain-douche extensible

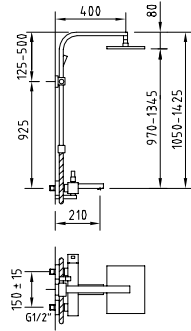

Incluye
Includes
Inclus



145x200
99686



Marina
96786



1,75 m
97670



Pascua
97112

Ref.	€	
ec2	97055	1.000,00 3

Más información Pág. 32
More information / Plus d'informations

BIMINI

CONJUNTO DE DUCHA EXTENSIBLE |
Extensible shower system |
Colonne mitigeur douche extensible

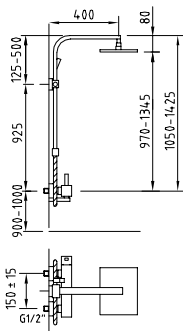

Incluye
Includes
Inclus



145x200
99686



Marina
96786



1,75 m
97670



Pascua
97112

Ref.	€	
ec2	97056	950,00 3

Más información Pág. 32
More information / Plus d'informations

PAULA

CONJUNTO DE DUCHA EXTENSIBLE
Shower system
Colonne mitigeur douche extensible

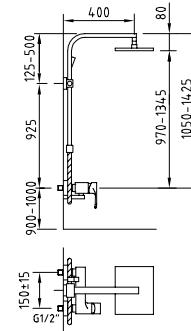

Incluye
Includes
Inclus



Marina
96786



145x200
99686



1,75 m
97670



Pascua
97112

Ref.	€	
ec1	98415	700,00 4

Más información Pág. 40
More information / Plus d'informations

Sistemas de ducha y baño-ducha

Shower and bath-shower systems
Colonne douche et bain-douche

MONOMANDOS EXTENSIBLES ADJUSTABLE SINGLE LEVERS / MITIGEURS EXTENSIBLES

CIRCULAR MANUAL BOX

CONJUNTO DE DUCHA EXTENSIBLE
Adjustable shower system
Colonne mitigeur douche extensible



Incluye
Includes
Inclus

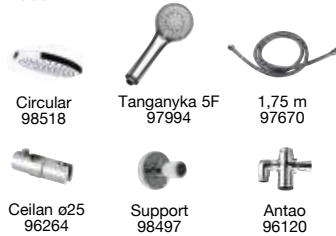

Circular
98518

Tanganyka 5F
97994

1,75 m
97670



Ceilan ø25
96264



Support
98497



Antao
96120

Ref.	€	
ec1 98527	309,00	4*

* (Pack indivisible de 4 unidades)
(Indivisible packaging of 4 units)
(Pack indivisible de 4 unités)

Más información Pág. 155
More information / Plus d'informations

Inversor incorporado en la maneta de caudal
Diverter built in the flow handle
Inverseur intégré dans la poignée

START elegance

CONJUNTO DUCHA EXTENSIBLE
Extensible shower system
Colonne mitigeur bain-douche extensible

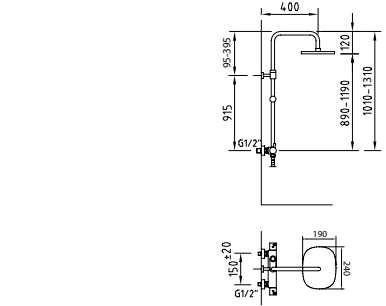

Incluye
Includes
Inclus



Style AIR
99606

Style AIR
99611

1,75 m
97670



Ceilan
96264



98497

Ref.	€	
99646	360,00	-

Más información Pág. 80
More information / Plus d'informations

Inversor incorporado en la maneta de caudal
Diverter built in the flow handle
Inverseur intégré dans la poignée

START Xtreme

CONJUNTO DUCHA EXTENSIBLE
Extensible shower system
Colonne mitigeur bain-douche extensible

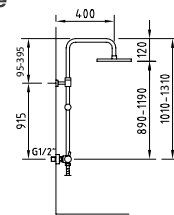

Incluye
Includes
Inclus



Trend
99608

Trend
99609

1,75 m
97670



Ceilan
96264



98497

Ref.	€	
ec3 99727	360,00	-

Más información Pág. 84
More information / Plus d'informations

Inversor incorporado en la maneta de caudal
Diverter built in the flow handle
Inverseur intégré dans la poignée

NINE elegance

CONJUNTO DE DUCHA EXTENSIBLE
Extensible shower system
Colonne mélangeur douche extensible

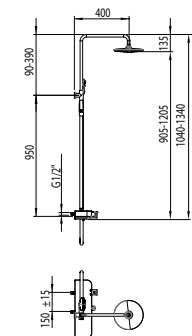

Incluye
Includes
Inclus



Style Air
240x190
99606

Style Air
100x120
99611

Silver Hose
1,75 m
98880

Ceilan
96264

Ref.	€	
99732	500,00	4

Más información Pág. 43
More information / Plus d'informations

Inversor incorporado en la maneta de caudal
Diverter built in the flow handle
Inverseur intégré dans la poignée

BIMANDOS EXTENSIBLES
ADJUSTABLE TWO HANDLES / MELANGEURS EXTENSIBLES

WITH2 antigua
CONJUNTO DE DUCHA EXTENSIBLE
Extensible shower system
Colonne mélangeur douche extensible

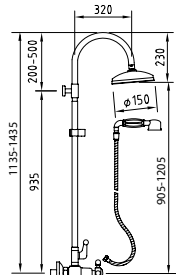
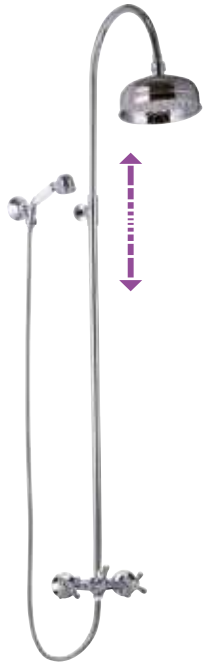

Incluye
Includes
Inclus



Ref.	€	📦
96154	440,00	3

Más información Pág. 67
More information / Plus d'informations

WITH2 antigua
CONJUNTO DE BAÑO-DUCHA EXTENSIBLE
Extensible bath-shower system
Colonne mélangeur bain-douche extensible

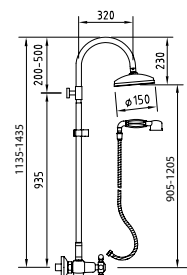
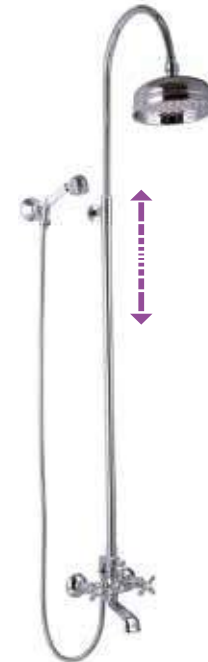

Incluye
Includes
Inclus



Ref.	€	📦
96747	483,00	3

Inversor incorporado en la maneta de caudal
Diverter built in the flow handle
Inverseur intégré dans la poignée

Más información Pág. 67
More information / Plus d'informations

MONOMANDOS NO EXTENSIBLES
NON-ADJUSTABLE SINGLE LEVERS / MITIGEURS NON EXTENSIBLES

KUADRAT MANUAL BOX
CONJUNTO DE DUCHA
Shower system
Colonne mitigeur douche

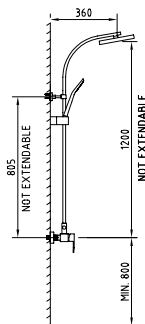
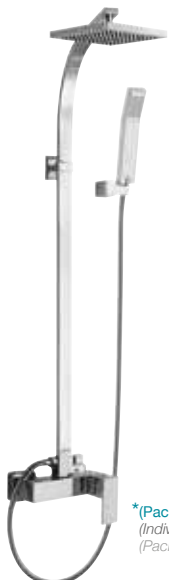

Incluye
Includes
Inclus



Ref.	€	📦
ec1 98850	482,00	4*

*(Pack indivisible de 4 unidades)
(Indivisible packaging of 4 units)
(Pack indivisible de 4 unités)

Más información Pág. 154
More information / Plus d'informations

CIRCULAR MANUAL BOX
CONJUNTO DE DUCHA
Shower system
Colonne mitigeur douche

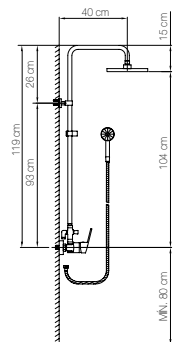

Incluye
Includes
Inclus



Ref.	€	📦
ec1 99142	279,00	4*

*(Pack indivisible de 4 unidades)
(Indivisible packaging of 4 units)
(Pack indivisible de 4 unités)

Más información Pág. 155
More information / Plus d'informations



Cisternas empotradas
 Concealed cisterns
 Réservoirs encastrés
 234



Mecanismos descarga
 Flush valves
 Mécanismes chasse d'eau
 235



Sifones
 Bottle trap
 Siphons
 236



Válvulas escuadra
 Angle valves
 Robinets d'équerre
 236



Desagües
 Pop-up wastes
 Vidages
 237

Complementos y recambios

Accesories and spare parts
Accessoires et pièces de rechange



Manetas
Handles
Manettes
238



Inversores
Diverter
Inverseurs
240



Cartuchos
Cartridges
Cartouches
240



Aireadores
Aerators
Aérateurs
242



Accesorios de cocina
Kitchen accessories
Accessoires de cuisine
244



Recambios
Spare parts
Pièces de rechange
245

Cisternas empotradas Concealed cisterns Réservoirs encastrés

ANADYR

Cisterna empotrada para WC al suelo.
Placa doble pulsador incluida
Concealed cistern for wall-hung WC installation.
Dual push plate included.
Réservoir encastré pour wc suspendu ou au sol.
Plaque double poussoir.

Ref.	€	
98324	155,00	1

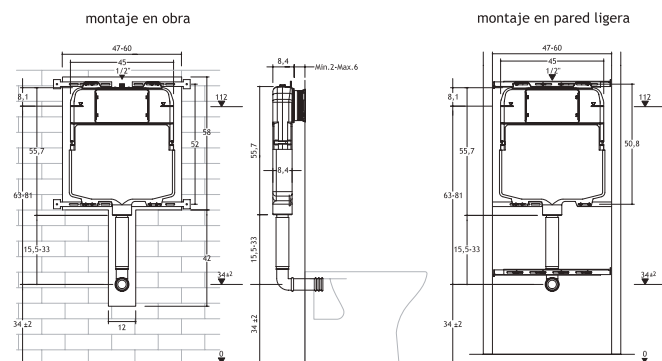
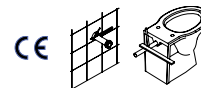

KOLYMA

Cisterna empotrada con bastidor para WC suspendido al suelo.
Placa doble pulsador incluida
Concealed cistern with frame for floor-standing WC. Dual push plate included.
Réservoir encastré avec bâti pour wc au sol.
Plaque double poussoir.

Ref.	€	
98325	330,00	1

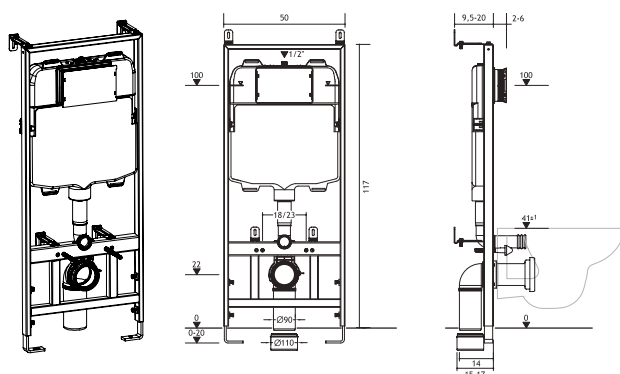
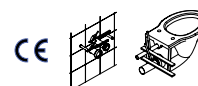

BERING

Placa doble pulsador cromo.
Chromed plated dual push.
Plaque commande double chromée.

Ref.	€	
98326	39,00	32

Mecanismos descargas

Flush valves
Mécanismes chasse d'eau

OBI

Válvula alimentación inferior. Silencioso, rápido y compacto.
Bottom fill valve. Silent, quick and compact.
Arrivée d'eau inférieure. Silencieux, rapide et compact.

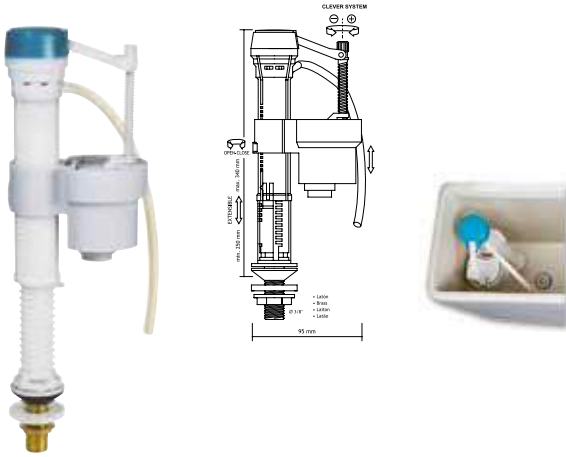

Ref.	€	📦
98320	19,00	4



LENA

Válvula alimentación lateral. Silencioso, rápido y compacto.
Side fill valve. Silent, quick and compact.
Arrivée d'eau latérale. Silencieux, rapide et compact.

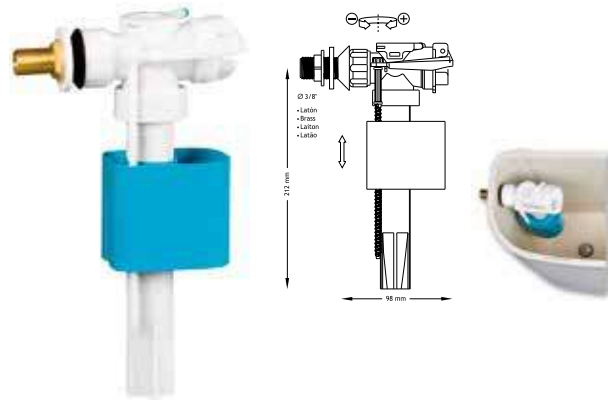

Ref.	€	📦
98321	19,00	4



VOLGA

Descarga eco-control interrumpible. Fácil montaje.
Volumen total interrumpible (opcional).
Water saver press & stop flushing valve. Easy assembly.
Interruptable flush (optional).
Possibilité d'interruption du vidage du réservoir

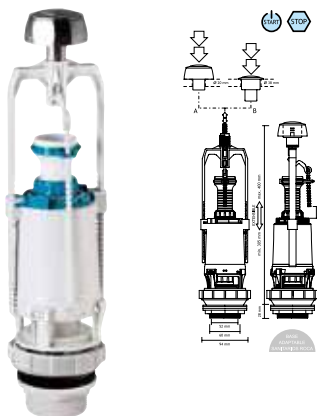

Volumen total interrumpible (opcional).
Interruptable flush (optional).
Possibilité interruption volume total (en option).

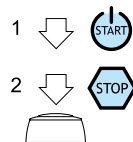

Ref.	€	📦
98322	32,00	4



AMUR

Descarga eco-control con cable.
Water saver cable flushing valve.
Décharge éco-contrôle à câble.

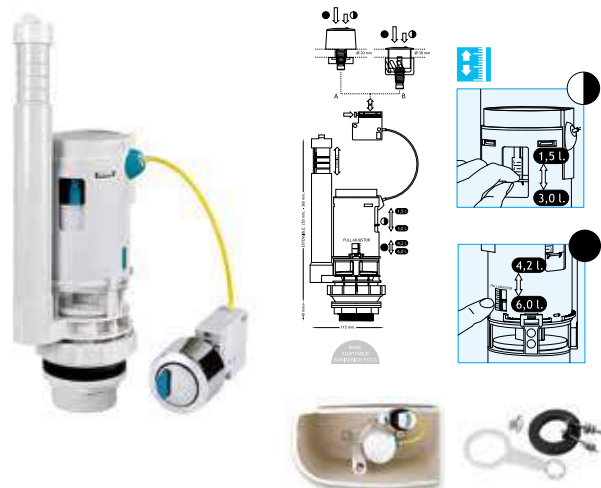

Ref.	€	📦
98323	40,00	4



Sifones

Siphons / Siphons

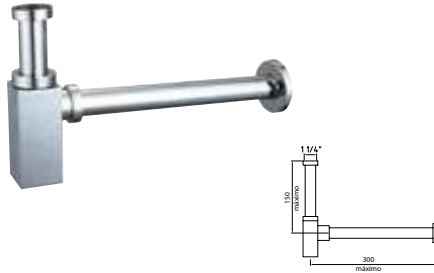

xtreme

SIFÓN BOTELLA LATÓN
Brass bottle trap | Siphon laiton

Sifón botella de 1 1/4" de lujo para lavabos de encimera, longitud de tubo lateral hasta 300 mm, longitud del tubo vertical 150 mm, tubo de 32 mm Ø. Luxury square bottle trap 1 1/4" for basin, lateral tube 300 mm long, vertical tube length, 150 mm. Tube 32 mm Ø.

Siphon 1 1/4" de luxe pour vasques à encastrer, longueur de tube latéral 300 mm, longueur de tube vertical 150 mm, tube de 32 mm Ø.

Ref.	€	📦
96173	50,00	10

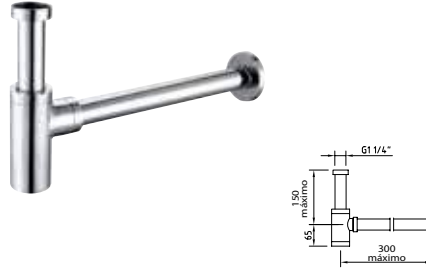

elegance

SIFÓN BOTELLA LATÓN
Brass bottle trap | Siphon laiton

Sifón botella de 1 1/4" de lujo para lavabos de encimera, longitud de tubo lateral hasta 300 mm, longitud del tubo vertical 150 mm, tubo de 32 mm Ø. Luxury square bottle trap 1 1/4" for basin, lateral tube 300 mm long, vertical tube length, 150 mm. Tube 32 mm Ø.

Siphon 1 1/4" de luxe pour vasques à encastrer, longueur de tube latéral 300 mm, longueur de tube vertical 150 mm, tube de 32 mm Ø.

Ref.	€	📦
96174	42,00	10

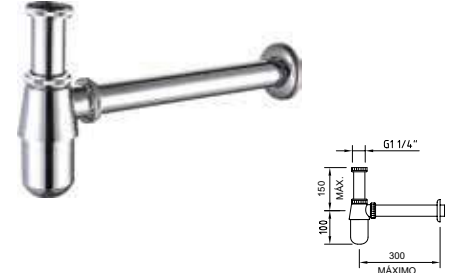

urban

SIFÓN BOTELLA LATÓN
Brass bottle trap | Siphon laiton

Sifón horizontal de botella de 1 1/4" para lavabos de encimera, longitud de tubo horizontal 300 mm, longitud de tubo vertical 150 mm, tubo de 32 mm Ø. Bottle bottle trap 1 1/4" for basin, lateral tube 300 mm long, vertical tube length, 150 mm. Tube 32 mm Ø. Siphon bouteille de 1 1/4" pour vasques à encastrer, longueur de tube horizontal 300 mm, longueur de tube vertical 150 mm. Tube 32 mm Ø.

Ref.	€	📦
90755	22,00	10

Válvulas escuadra

Angle valves / Robinets d'equerre

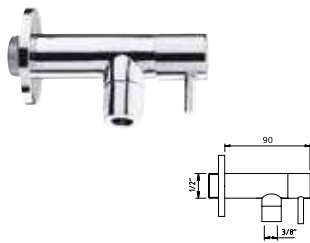

NEVIS

VÁLVULA ESCUADRA
Angle valve | Robinet d'equerre

1/2" x 3/8"

Latón cromado. Cierre discos cerámicos. Brass chrome. Ceramic disc. Laiton chromé. Tête céramique 1/4 de tour

Ref.	€	📦
ACS 96137	15,00	48



DESIGN

VÁLVULA ESCUADRA
Angle valve | Robinet d'equerre

1/2" x 3/8"

Latón cromado. Cierre discos cerámicos. Brass chrome. Ceramic disc. Laiton chromé. Tête céramique 1/4 de tour

Ref.	€	📦
40010	12,00	48
40011	12,00	48

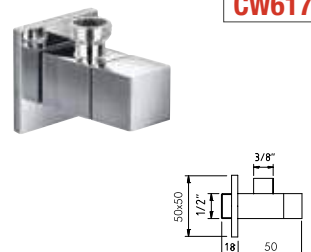

BIMINI

VÁLVULA ESCUADRA
Angle valve | Robinet d'equerre

1/2" x 3/8"

Latón cromado. Cierre discos cerámicos. Brass chrome. Ceramic disc. Laiton chromé. Tête céramique 1/4 de tour

Ref.	€	📦
97106	16,00	60



MINAMI

VÁLVULA ESCUADRA CON FILTRO
Angle valve with filter
Robinets d'equerre avec filtre

1/2" x 3/8"

Latón cromado. Cierre discos cerámicos. Brass chrome. Ceramic disc. Laiton chromé. Tête céramique 1/4 de tour

Ref.	€	📦
97107	15,50	90



Desagües Pop-up / Vidages

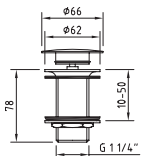

VELA

VÁLVULA DESAGÜE SISTEMA QUICK-CLAC Basin click waste | Vidage quick-clac

Sin rebosadero. Metálico.
Without overflow. Metallic
Pour vasque à poser sans trop plein. Métallique

Con rebosadero. Metálico.
With overflow. Metallic
Pour lavabo et bidet avec trop-plein. Métallique

Ref.	€	
97395	17,00	50
96255	17,00	50

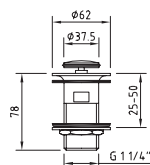

ORION

VÁLVULA DESAGÜE SISTEMA QUICK-CLAC Basin click waste | Vidage quick-clac

Con rebosadero. Metálico.
With overflow. Metallic
Pour vasque à poser avec trop plein. Métallique

Ref.	€	
96254	17,00	50

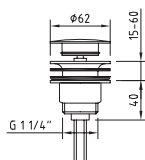

Sintético
Synthetic · Synthétique

LEO

VÁLVULA DESAGÜE SISTEMA QUICK-CLAC Basin click waste | Vidage quick-clac

Válvula desagüe Universal. Sintético. 1 1/4"
Universal drain quick-clac. Synthetic 1 1/4"
Vidage Universel. Synthétique. 1 1/4"

Ref.	€	
60558	11,00	50

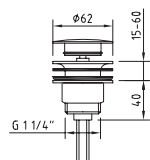

Metálico
Metallic · Métallique

LEO

VÁLVULA DESAGÜE SISTEMA QUICK-CLAC Basin click waste | Vidage quick-clac

Válvula desagüe Universal. Metálico.
Universal drain quick-clac. Metallic
Vidage Universel. Métallique

Ref.	€	
98674	14,00	1
Box (Pack 24)	60418	13,00 24

NEW

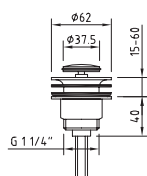

LYNX

VÁLVULA DESAGÜE SISTEMA QUICK-CLAC Basin click waste | Vidage quick-clac

Válvula desagüe Universal. Metálico.
Universal drain quick-clac. Metallic
Vidage Universel. Métallique

Ref.	€	
98673	13,00	50

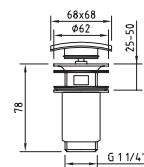

HYDRA

VÁLVULA DESAGÜE SISTEMA QUICK-CLAC Basin click waste | Vidage quick-clac laiton

Válvula desagüe Universal. Metálico.
Universal drain quick-clac. Metallic
Vidage Universel. Métallique

Ref.	€	
98675	17,00	50

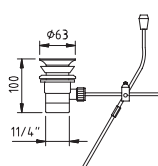

METÁLICO - Desagüe automático Metallic - Pop-up waste Métallique - Vidage laiton

Desagüe automático de 1 1/4" con tirador para lavabo y bidé.
Pop-up 1 1/4" for basin and bidet.
Vidage automatique 1 1/4" pour lavabo/bidet.

Ref.	€	
99127	14,00	50

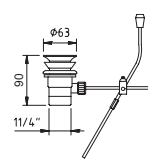

SINTÉTICO - Desagüe automático Synthetic - Pop-up waste Synthétique - Vidage laiton

Desagüe automático de 1 1/4" con tirador para lavabo y bidé.
Pop-up 1 1/4" for basin and bidet.
Vidage automatique 1 1/4" pour lavabo/bidet.

Ref.	€	
92901	5,00	50
99130	8,00	50

Manetas

Handles/ Manettes

Clever Platinum



Ref.	Serie	€	Standard	Invertida Inverted
99426	VENTU	20,00	○	
99427	VENTU	20,00		○
95163	AUDE	20,00	○	
95164	AUDE	20,00		○
95168	SELENE	20,00	○	
95169	SELENE	20,00		○
95165	BIMINI Ø35	20,00		○
95167	BIMINI bimando	20,00	○	
95178	BIMINI Ø40	20,00	○	
99424	MARINA EVO	20,00	○	
99425	MARINA EVO	20,00		○
95244	SAONA SLIM Ø26	20,00	○	
95245	SAONA SLIM Ø35	20,00	○	
95246	SAONA SLIM Ø26	20,00		○
98215	PAULA	20,00	○	
98216	PAULA	20,00		○

Chef/Inox/Osmosis



Ref.	Serie	€	Standard	Invertida Inverted	C3 Invertida Inverted
95158	CHEF	20,00		○	
98758	CHEF CARBON	20,00		○	
99446	CHEF 35	20,00		○	
99447	CHEF 35	20,00			○
99659	CHEF 35 MATE	20,00			○
95247	CHEF 25	20,00			○
99852	INOX FINISH	20,00		○	
95248	OSMOSIS ROUND 35	20,00			○
95250	OSMOSIS ROUND	12,00	○		
95249	OSMOSIS SQUARE 35	20,00			○
95251	OSMOSIS SQUARE	12,00	○		
98631	OSMOSIS (Para 97806-99684)	12,00	○		
98632	OSMOSIS (Para 96419-98760)	12,00	○		
60315	CHEF 6 BLANCA	20,00			○
60316	CHEF 25 SLIM MATE	20,00			○
60317	CHEF 25 SLIM BLANCA	20,00			○
60318	CHEF 25 SLIM NEGRA	20,00			○

Clever Styles



Ref.	Serie	€	Standard	Invertida Inverted	C3	C3 Invertida Inverted
95183	AGORA ELEGANCE	12,00	○			
95184	AGORA ELEGANCE	12,00		○		
95242	AGORA XTREME	12,00	○			
95243	AGORA XTREME	12,00				○
95185	ARTIC XTREME	12,00	○			
95186	ARTIC XTREME	12,00				○
95187	ARTIC XTREME	12,00			○	
98240	ARTIC URBAN	12,00	○			
98241	ARTIC URBAN	12,00		○		
95133	CAIMAN ELEGANCE Ø40	20,00	○			
95135	CAIMAN ELEGANCE bimando	20,00	○			
95132	CAIMAN ELEGANCE Ø35	20,00	○			
98212	CAIMAN XTREME	12,00	○			
98213	CAIMAN XTREME	12,00		○		
98242	CAIMAN XTREME baño-ducha	12,00	○			
96223	CAIMAN URBAN	12,00	○			
94600	WITH2 ANTIGONA	11,50				
95126	WITH2 MOREA	20,00				

Clever Styles Pro



Ref.	Serie	€	Standard	Invertida Inverted	C3	C3 Invertida Inverted
98209	BAHAMA XTREME	12,00	○			
98210	BAHAMA XTREME	12,00		○		
95190	BAHAMA XTREME	12,00			○	
95191	BAHAMA XTREME	12,00				○
98206	HABANA XTREME	12,00	○			
95192	HABANA XTREME	12,00			○	
95234	START ELEGANCE	12,00	○			
95235	START ELEGANCE	12,00		○		
95236	START ELEGANCE	12,00			○	
95237	START ELEGANCE	12,00				○
95226	START XTREME	12,00	○			
95227	START XTREME	12,00		○		
95228	START XTREME	12,00			○	
95229	START XTREME	12,00				○
95181	START URBAN	12,00	○			
95182	START URBAN	12,00		○		
95193	START URBAN	12,00			○	
95194	START URBAN	12,00				○
96268	PANAM ELEGANCE	9,00	○			
96422	PANAM ELEGANCE	9,00		○		
95172	PANAM XTREME	9,00	○			
95173	PANAM XTREME	9,00		○		
95012	PANAM URBAN	9,00	○			
95110	PANAM URBAN	9,00		○		
95230	S12 ELEGANCE	9,00	○			
95231	S12 ELEGANCE	9,00		○		
95232	S12 ELEGANCE	9,00			○	
95233	S12 ELEGANCE	9,00				○
95222	S12 XTREME	9,00	○			
95223	S12 XTREME	9,00		○		
95224	S12 XTREME	9,00			○	
95225	S12 XTREME	9,00				○
95174	S12 URBAN 40	9,00	○			
95175	S12 URBAN 40	9,00		○		
95195	S12 URBAN 40	9,00			○	
95196	S12 URBAN 40	9,00				○
99224	S12 URBAN 35	9,00	○			
99225	S12 URBAN 35	9,00			○	

Ref.	Serie	€
96232	WITH2 GUAYAMA Fría/Cold/Froid	7,00
96233	WITH2 GUAYAMA Caliente/Hot/Chaud	7,00

97822	SHATAFF Monomando/ Single lever	9,00
97823	SHATAFF Bimando/ Two handle	9,00
96234	INDIVIDUAL - Single	3,50
96256	MEDICA - Medical	14,00
99217	S12 URBAN Medica	14,00

Standard

Invertida

Inverted



C3
Standard

C3
Invertida

Inverted



Cartuchos Cartridges/ Cartouches



INVERSOR | *Diverter* | *Poignée*

Inversor automático baño-ducha.
Bath-shower automatic diverter.
Inverseur automatique bain-douche.

	Ref.	€
 Hide diverter	97817	18,00
Selene	98008	18,00
Ventu	99664	18,00
Bimini	97474	18,00
Saona Infinity	96253	18,00
Marina	97475	18,00
Mikura	97379	18,00
Saona Slim	60129	18,00
Agora Xtreme	60114	18,00
Nine	98239	18,00

	Ref.	€
Saona	96216	14,50
Antao	96217	14,50
Caiman Urban	96213	14,50
Bahama urban	90770	10,00
Panam Urb.-S12 urban-Panam X. 	98490	9,75
Bimini empotrado	98491	14,50
Guayama - Madeira	95052	9,00
Para barra Bimini	60310	18,00

CARTUCHOS | *Cartridges* | *Cartouche*

				 	 	  <small>invertido</small>	 
Standard salida libre 	ø35	96199		97371	99667	99665	98868
	ø40	90760		97369	99668	99669	98866
Standard salida conducida 	ø25	97824					
	ø35	96205		97372			98869
		90763*					
	ø35 NF	99226	99227		99228	99656	
ø40	90761		97370	99670	99671	98867	
Tórica superior salida libre 	ø35	98238	98267		98872	99672	99673
Tórica superior Xtreme 	ø26	60130					
	ø35 NF	99540	99541		99542	99543	99674
		99817					
	ø40 NF	98870	98781		98902	98903	98871
ø40	98237	98630					

* Joystick

	Ref.	€	Ref.	€	
ec1	90760	9,50	ec3	98872	16,50
ec1	90761	9,50	C3	98902	16,00
	90763	20,00	C3	98903	16,00
ec1	96199	9,50	C1	99226	11,75
ec1	96205	9,50	C2	99227	14,80
ec2	97369	12,95	C3	99228	16,00
ec2	97370	12,95	C1	99540	12,00
ec2	97371	12,95	C2	99541	14,80
ec2	97372	12,95	C3	99542	16,00
ec1	97824	16,00	C3	99543	16,00
ec1	98237	9,50	C3	99656	16,00
ec1	98238	9,50	ec3	99665	16,25
ec2	98267	12,95	ec3	99667	16,25
ec2	98630	12,95	ec3	99668	16,25
C2	98781	15,00	ec3	99669	16,25
ec3	98866	13,30	ec3	99670	16,25
ec3	98867	13,30	ec3	99671	16,25
ec3	98868	13,30	ec3	99672	16,25
ec3	98869	13,30	ec3	99673	16,25
C1	98870	12,00	C3	99674	16,00
C3	98871	16,00	ec1	60130	16,00
			ec1	99817	12,00

Instrucciones de montaje de un cartucho, ver página 281

Cartridge assembly instructions. See page 281

Instructions de montage d'une cartouche, voir page 281



CARTUCHO INVERSOR ø30
Diverter cartridge | Cartouche inverseur

OFF. Para, for, pour: Nine Xtreme 60135
NO OFF. Para, for, pour: Start 99646-99747

Ref.	€
60139	16,00
60313	16,00



CARTUCHO INVERSOR ø27
Diverter cartridge | Cartouche inverseur

OFF. Para, for, pour: Nine Urban
NO OFF. Para, for, pour: 99732-60154

Ref.	€
98776	18,00
60312	16,00



MONTURA CERÁMICA
Ceramic Headwork
Tête céramique

	Ref.	€
Old Antigona	94458	8,00
Guayama - Antigona	96208	8,00
Guayama 92075 y 97974	94459	8,00
Caiman 98760	97697	8,00
Caiman 97806-99684	97698	8,00
Bimini 97054	97699	8,00



CARTUCHO
Cartridge | Cartouche

Cartucho termostático.
Thermostatic cartridge.
Cartouche pour thermostatique.

Para 60131,60133

Ref.	€
98027	50,00
99652	55,00
99736	55,00



cosedal

Para 98750



NINE
CARTUCHO CON VOLANTE
Cartridge with handle | Cartouche

Cartucho termostático con volante ABS cilíndrico.
Thermostatic cartridge with ABS cylindrical handle.
Cartouche céramique pour thermostatique, poignée ABS cylindrique.

Ref.	€
97829	72,00



cosedal



97827



97828

NINE
VOLANTE
Handle | Poignée

ABS

Volante ON/OFF.
ON/OFF handle./Poignée ON/OFF.

Volante termostático.
Thermostatic handle./ Poignée thermostatique.

Ref.	€
97827	5,00
97828	5,00



CARTUCHO
Cartridge | Cartouche

Cartucho temporizado M26.
Delay action cartridge M26.
Cartouche temporisée M26.

Ref.	€
96161	19,00

7 segundos - seconds

Ref.	€
96164	19,00

14 segundos - seconds



cosedal



60416



60417

NINE SLIM urban
VOLANTE
Handle | Poignée

ABS

Volante ON/OFF.
ON/OFF handle./Poignée ON/OFF.

Volante termostático.
Thermostatic handle./ Poignée thermostatique.

Ref.	€
60416	5,00
60417	6,00



Aireadores Aerators/ Aérateurs

AIREADOR con mezcla aire/agua variable



Permite que el usuario escoja el grado de mezcla aire/agua que necesita sin limitador de caudal.

AERATOR, MIXING AIR AND WATER. Allows the user to choose the necessary mixing level air/water without using a flow limiter.

AÉRATEUR, AVEC MÉLANGE AIR/EAU VARIABLE. Permet à l'utilisateur de choisir la proportion de mélange air/eau dont il a besoin sans limiteur de débit.

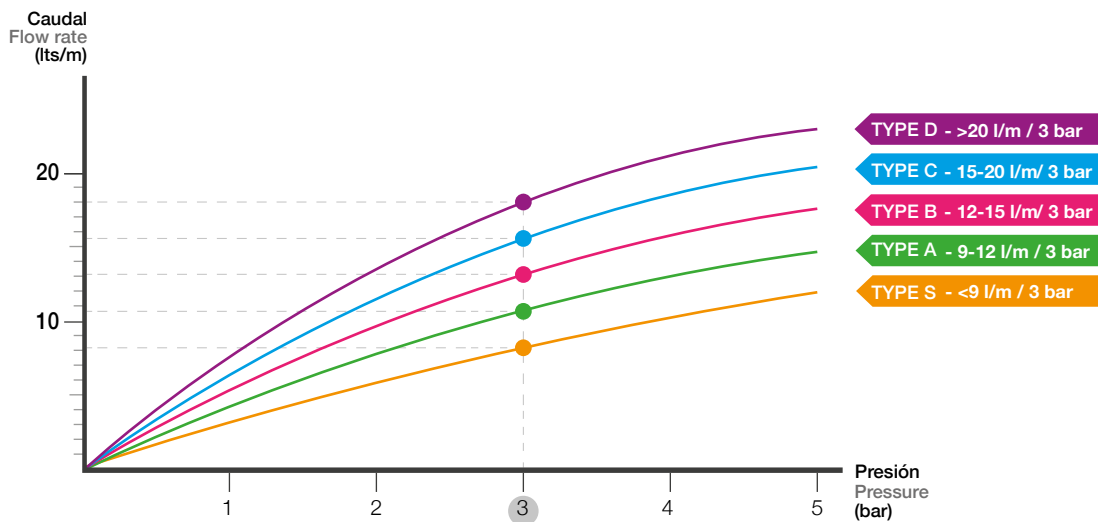

		TYPE S <9 l/m - 3 bar	TYPE A 9-12 l/m - 3 bar	TYPE B 12-15 l/m - 3 bar	TYPE C 15-20 l/m - 3 bar	TYPE D >20 l/m - 3 bar
Male 	M20	96202	97689			
	M24	99230	99229	90025	99231	96200
	M24 filtro silicona			98926		
	M28				99233	90027
Female 	M20			98601		
	M22	99853 Inox	99232	90026		
	M22 filtro silicona			98927		
Rectangular 	28x7		99661			
	32x8		98492			
	40x10		99660		98493	
Slim-orientable 	M24			98774		98775
Empotrado 	M18	60149				
CoinSlot 	M24		60155			
Osmosis 	M22			60153		
	M24			99737		

Ref.	€	Ref.	€	Ref.	€	Ref.	€	Ref.	€	Ref.	€	Ref.	€
96202	4,75	99229	5,75	98492	27,00	98926	6,75	98927	6,75	99233	5,75	90027	5,75
99230	5,75	99232	5,75	99660	27,00	98601	4,75	98774	5,75	98493	31,00	98775	9,00
97689	4,75	99661	22,00	90025	5,75	90026	5,75	99231	5,75	96200	5,75	99853	6,75
												60153	14,50
												99737	15,00

AIREADOR con límite de caudal máximo

Permite limitar el caudal máximo, independientemente de la posición de la maneta, consiguiendo así un mayor ahorro de agua. (No recomendable para grifería de bañera).





AERATOR, WITH MAXIMUM FLOW LIMIT.

To limit the maximum flow rate regardless the handle position, saving more water. (it is not recommended for bath mixers)

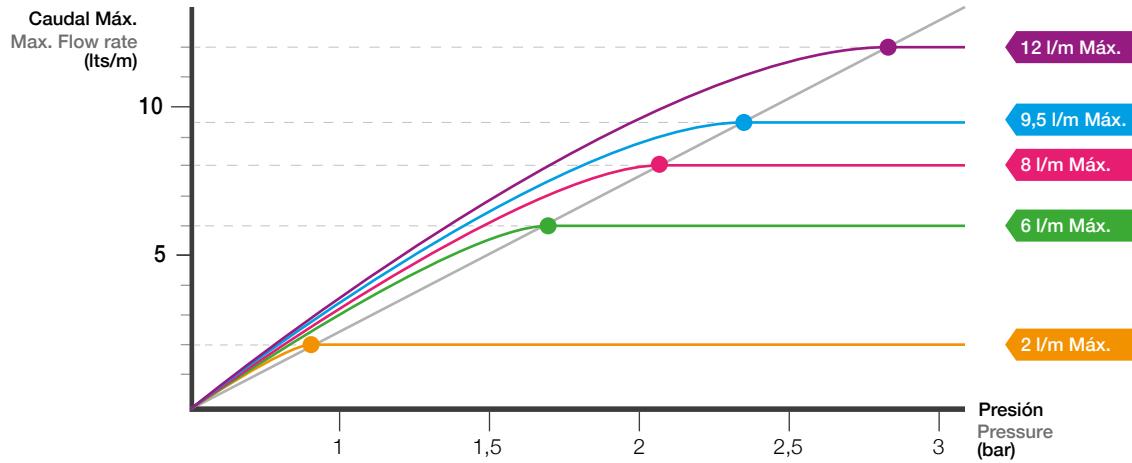
AÉRATEUR, AVEC LIMITE DE DÉBIT MAXIMUM

Permet de limiter le débit maximum indépendamment de la position de la manette, obtenant ainsi une économie d'eau supplémentaire (non recommandé pour la robinetterie de baignoire).



		2 l/m Máx.	6 l/m Máx.	8 l/m Máx.	9,5 l/m Máx.	12 l/m Máx.
Male 	M24	98788	98787	98793		
Female 	M22	98794	98789	98795		
Slim-orientable 	M24		98791	98792		
Ducha Baño 	1/2"		98796		98786	98797

Ref.	€	Ref.	€
98788	5,90	98793	4,50
98794	4,50	98795	4,50
98787	4,75	98792	6,10
98789	5,90	98786	2,35
98791	6,10	98797	2,35
98796	2,35		



RÓTULA BIDÉ
Ball-joint aerator | Rotule bidet

Rótula bidé. M24 - M22
Knee- cap. M24 - M22.
Rotule bidet. M24 -M22.

Ref.	€
96201	6,50

Accesorios cocina

Kitchen accessoires
Accessoires de cuisine

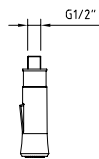

DUCHA DE PISTOLA Dishwashing pull-out | Douchette

98759: para, for, pour: 98757 - 98764 - 99440
99441 - 99443 - 99444 - 60142

99658: para, for, pour: 99445 (Mate)

ABS



Ref.	€	📦
98759	30,00	50
99658	30,00	50

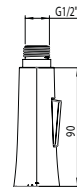

DUCHA DE PISTOLA Dishwashing pull-out | Douchette

60314: Para, for, pour: 99733-99735

99657: Para, for, pour: 99442

ABS



Ref.	€	📦
60314	30,00	-
99657	30,00	50

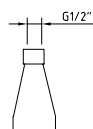

DUCHA DE PISTOLA Dishwashing pull-out | Douchette

Para, for, pour: 96755 - 97804

ABS



Ref.	€	📦
97364	30,00	50

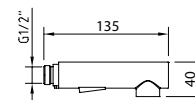

DUCHA DE PISTOLA Dishwashing pull-out | Douchette

Para, for, pour: 98689

ABS



Ref.	€	📦
99174	30,00	-

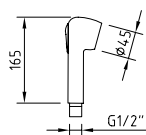

DUCHA Pull-out handshower for sink mixer | Douchette

Para fregadero 97069 - 98552 - 98180

Pull-out handshower for sink mixer

97069 - 98552 - 98180

Pour évier 97069 - 98552 - 98180

ABS



Ref.	€	📦
90794	17,00	50

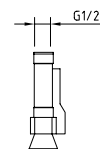

DUCHA DE PISTOLA Dishwashing pull-out | Douchette

Para, for, pour: 96175 - 96176

Metálico / Metallic / Métallique



Ref.	€	📦
96273	90,00	50



Recambios Spare parts Pièces de rechange

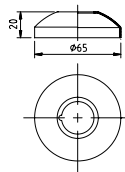

FLORONES Flange | Rosace

Metálico cromado (2 piezas)
Chromed metal (2 pieces)
Métal chromé (2 pièces)

Ref.	€	📦
95043	3,75	10

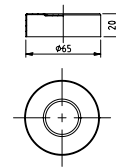

FLORONES Flange | Rosace

Florón lomo plano (2 piezas). Cromado
Flange (2 pieces). Chromed
Rosace (2 pièces). Chromé

Ref.	€	📦
96238	5,40	10

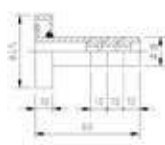

SOPORTE PARED Wall support | Support mural

Soporte pared para conjuntos de ducha.
Wall support for shower set.
Support mural.

Ref.	€	📦
ø 25 98497	14,50	10
ø20 98998	12,00	10

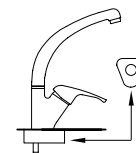

REFUERZO FREGADEROS Reinforcement sink | Renfort robinet évier

Universal
ø35

ABS



Ref.	€	📦
97688	2,00	90

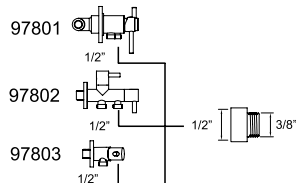
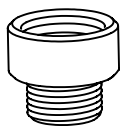

SHATTAF REDUCTOR Reducer connection | Réducteur de connexion

Latón cromado
Brass chromed
Laiton chromé

1/2"H x 3/8"M

1/2"F x 3/8"M

Ref.	€	📦
97825	3,40	20

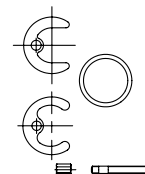

CONJUNTO DE FIJACIÓN Fixing set | Set de fixation

Conjunto de fijación para lavabo, bidé y fregadero.
Fixing set rim mounted faucets (basin, bidet, sink).
Set de fixation (lavabo, bidet, évier).

96267: Largo - Long / 110mm
95040: Universal

Ref.	€	📦
96267	6,00	20
95040	2,50	20

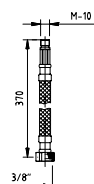

FLEXIBLE DE ALIMENTACIÓN Flexible connections | Raccords flexibles

99862/98666: M-10 x 370 mm x 3/8"
DN6
EPDM.



98667: M-10 x 370 mm x 3/8"
DN6
PEX

98986: M-10 x 420 mm x 3/8"
DN6
EPDM

96243: M-10 x 370 mm x 3/8"
DN8
EPDM

Ref.	€	📦
98666	2,50	250
99862	2,50	250
98667	2,60	250
98986	2,60	250
96243	2,60	250



Recambios Spare parts Pièces de rechange

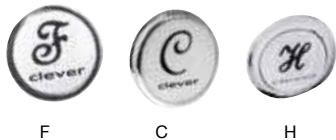

INDICES Indice | Index

ABS

	Ref.	€	📦
Antigona F	95044	2,10	10
Antigona C	95045	2,10	10
Antigona H	95046	2,10	10
	Ref.	€	📦
Universal	97363	1,15	10



ADAPTADOR Adapter | Adaptateur

Adaptador para tubo PE 1/4" - 7/16"-24 H (para 97104, 97806, 98760, 60150, 60151, 99684).
Adapter for PE 1/4" - 7/16"-24 F pipe (for 97104, 97806, 98760, 60150, 60151, 99684).
Adaptateur tubo PE 1/4" - 7/16"-24 H (pour 97104, 97806, 98760, 60150, 60151, 99684).



	Ref.	€	📦
	97399	6,40	10

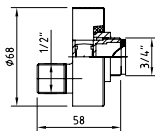

3/4"x1/2" (2 unidades, 2 units, 2 unités)
Conjunto Excéntrica con válvula
On/Off + filtro + florón
Eccentric nut On/Off valve +
filter + flange
Vanne excentrique On/Off +
filtre + rosace

	Ref.	€	📦
	98647	38,00	2

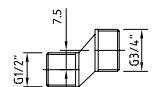

3/4"x1/2" (2 unidades, 2 units, 2 unités)
Excéntricas
Eccentric nut- Excentré

95042: Universal
96299: Con disminución ruido
With noise reduction / Avec silencieux



	Ref.	€	📦
	95042	7,00	25
	96299	9,00	10

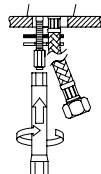

HERRAMIENTA DESMONTAJE
CONJUNTO FIJACIÓN
Dismantling tool for fixation set
Outil de démontage ensemble de fixation

Hexagonal 11

	Ref.	€	📦
	98751	3,50	1



HERRAMIENTA DESMONTAJE AIREADOR
Dismantling tool for aerator
Outil de démontage aérateur

Universal M-28-M24-M22

	Ref.	€	📦
	98752	3,50	1



ANTIGONA

INVERSOR
Diverter | Inverseur

Inversor manual baño-ducha.
Diverter for bath-shower.
Inverseur manual.

	Ref.	€	📦
	95051	11,75	20

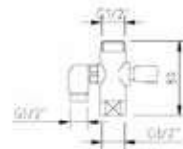

ANTAO

INVERSOR
Diverter | Inverseur

Distribuidor Antao para tubo de conjunto de ducha.
Diverter for shower set with tube.
Inverseur Antao.

	Ref.	€	📦
	96120	39,00	20

NEW

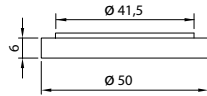

BASE PLÁSTICA S12 / START
Plastic base | Base en plastique

ABS
Ø50

Ref.	€	
60559	3,80	-

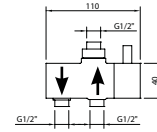

KIT BOX

INVERSOR
Diverter | Inverseur

Distribuidor para 99136/99623
Diverter for 99136/99623
Inverseur pour 99136/99623



Ref.	€	
99172	39,00	-

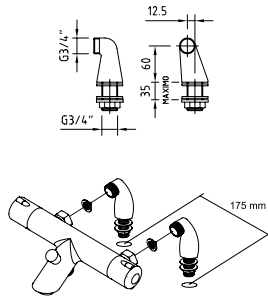

EXTENSIONES
Extensions | Extensions

Extensiones 3/4" x 3/4" (2 unidades). No Mikura, no Marina.
Extensions 3/4" x 3/4" (2 units). Not Mikura, not Marina.
Colonnets excentrées 3/4" x 3/4" (2 unités)

Ref.	€	
96292	42,00	10

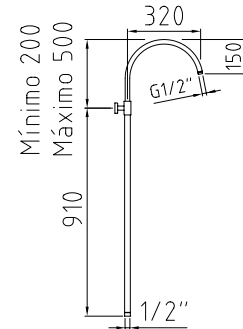

CROSS Ø25

EXTENSIBLES
Adjustable | Extensible

Tubo extensible recto para conjuntos ducha.
Latón cromado
Adjustable tube for shower set. Brass chromed
Barre extensible. Laiton chromé

Ref.	€	
96118	185,00	4

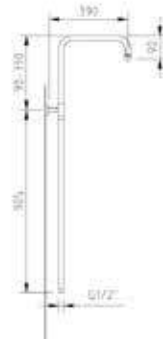

CIRCULAR Ø25

EXTENSIBLES
Adjustable | Extensible

Tubo extensible recto para conjuntos ducha.
Latón cromado
Adjustable tube for shower set. Brass chromed
Barre extensible. Laiton chromé

Ref.	€	
98517	185,00	4

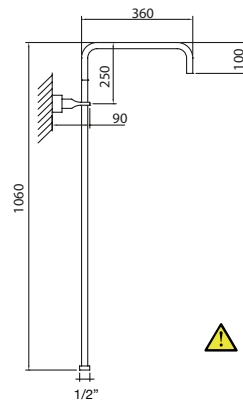

BASIC BOX

Tubo recto para conjuntos ducha.
Acero inox cromado
Tube for shower set. Stainless steel chromed
Barre. Inox chromé

⚠ NO EXTENSIBLE
NOT EXTENDABLE
NON EXTENSIBLE

Ref.	€	
98996	120,00	20



Expositores Clever, perfectos para tu tienda

Floorstand, perfect for your shop
Présentoir Clever, parfait pour votre comptoir



Expositores sobremesa
Display stand over-table
Présentoirs
250



Clever Maxi
252

Expositores sobremesa Display stand over-table Présentoirs

NEW



CLEVER KITCHEN

EXPOSITOR SOBREMESA DE COCINA Kitchen faucet display stand over-table Présentoir cuisine

Grifería no incluida
Faucets not included
Robinetterie non comprise

Ref.	€	
95821	180,00	1

Posibles configuraciones
Possible configurations / Configurations possibles



Ref.	€	
Expositor Display / Présentoir 95821	180,00	1
Vinilo Vinyl / Vynyle 95666	52,00	1

Expositor 1



Ref.	€	
Expositor Display / Présentoir 95821	180,00	1
Vinilo Vinyl / Vynyle 95829	52,00	1

Expositor 2

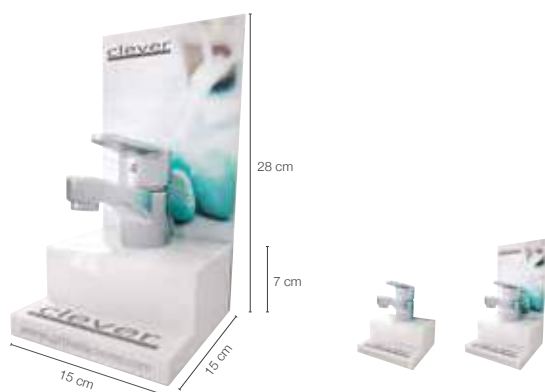

CLEVER ONE

EXPOSITOR SOBREMESA CON CARTELA IMANTADA Faucet display stand over-table with billboard magnetised Présentoir robinetterie avec panneau aimanté

Grifería no incluida
Faucets not included
Robinetterie non comprise

Posible configuración, con o sin cartela
Possible configurations, with or without billboard
Configurations possibles avec/sans panneau

Ref.	€	
95717	32,00	1



CLEVER MINI

EXPOSITOR SOBREMESA Faucet display stand over-table Présentoir robinetterie

Grifería no incluida
Faucets not included
Robinetterie non comprise

Incluye vinilo imantado APP Clever.
Magnetized vinyl APP Clever included.
Vynyle aimante APP Clever compris.



(9x9cm)

Ref.	€	
95540	94,00	1

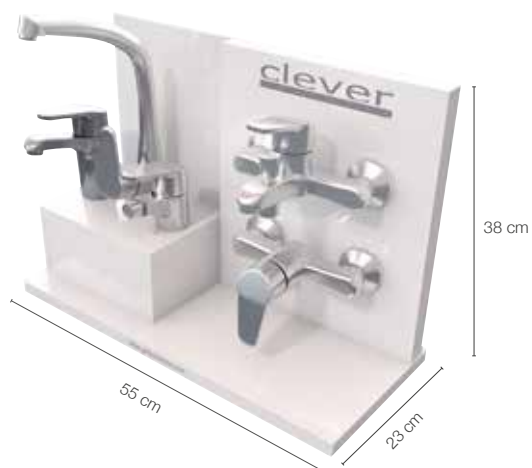

CLEVER FIVE
EXPOSITOR SOBREMESA
Faucet display stand over-table
Présentoir robinetterie

Grifería no incluida
 Faucets not included
 Robinetterie non comprise

Ref.	€	
95753	175,00	1



iCLEVER
EXPOSITOR iCLEVER SOBREMESA
iclever display stand over-table
Présentoir iclever

Grifería no incluida
 Faucets not included
 Robinetterie non comprise

Ref.	€	
95754	65,00	1



CLEVER SHATTAF
EXPOSITOR DUCHA HIGIÉNICA SOBREMESA
Shattaf display stand over-table
Présentoir douche hygiénique

Grifería no incluida
 Faucets not included
 Robinetterie non comprise

Ref.	€	
95755	75,00	1

Expositor Clever Maxi

Clever maxi display
Présentoir Clever maxi

CLEVER MAXI. Personalízalo a tu manera.

Clever maxi. Customize it as you want / Clever maxi. Personnalisez-les à votre goût



95667
Expositor modular metálico
Metal faucet display stand
Présentoir métallique



95749
Soporte repisa
para fregadero extraíble
Pull-out sink mixersupport
Support pour évier avec
douchette extractible



95668
Soporte repisa
para lavabo, bidé o fregadero
Support for basin, bidet or sink
Support pour lavabo, bidet ou évier



95756
Soporte doble repisa
para lavabo, bidé o fregadero
Double support for basin, bidet or sink
Double support pour lavabo, bidet ou évier



95669
Soporte baño-ducha o ducha
Support for bath-shower or shower
Support pour bain-douche ou douche



95663
Pieza blanca
White piece
Pièce blanche



95670
Soporte de madera
para duchas teléfono
Wood Holder for handshower
Support en bois pour douchettes



95824
Soporte repisa
para duchas teléfono
Support for handshower
Support pour douchettes

NEW



95832
SopORTE doble
para Nine Elegance
y Nine Xtreme
 Double support for Nine Elegance and
 Nine Xtreme
 Double support pour Nine Elegance
 et Nine Xtreme

NEW



95828
SopORTE doble de madera
 Double wood Holder
 Double support en bois

NEW

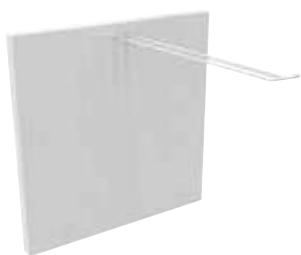

95839
SopORTE con un gancho
 Support with one hook
 Support avec un crochet

NEW



95840
SopORTE con dos ganchos
 Support with two hooks
 Support avec deux crochets

NEW





95837
Bandeja simple
 Simple tray
 Plateau simple
 30 x 30 x 27 cm

NEW



95838
Bandeja doble
 Double tray
 Double plateau
 30 x 60 x 27 cm

Ref.	€	
95667	520,00	1
95749	37,00	1
95668	32,00	1
95756	40,00	1
95669	32,00	1
95663	21,00	1
95670	42,00	1

Ref.	€	
95824	52,00	1
95832	90,00	1
95828	90,00	1
95839	40,00	1
95840	42,00	1
95837	50,00	1
95838	90,00	1

Expositor Clever Maxi

Clever maxi display
Présentoir Clever maxi

Decora tu Clever Maxi con la cartela trasera o vinilos imantados
Decorate your Clever maxi / Décorer votre Clever maxi



95671
Imagen trasera
(uso recomendado cuando el expositor NO va contra la pared)
Rear image
(recommended use when the display is not placed against the wall)
Image de fond
(utilisation recommandée lorsque le présentoir n'est pas contre le mur)



95664
Vinilo imantado
Imagen ducha
Magnetized vinyl. Shower Image
Vinyle aimanté. Image de douche



95665
Vinilo imantado. Imagen baño
Magnetized vinyl. Mixer Image
Vinyle aimanté. Image de bain



95666
Vinilo imantado. Imagen cocina
Magnetized vinyl. Sink Image
Vinyle aimanté. Image de Cuisine

NEW



95829
Vinilo imantado. Imagen azulejos cocina
Magnetized vinyl. Tiles image
Vinyle aimanté. Image de tuiles

NEW

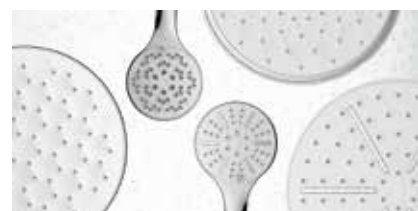

95806
Vinilo imantado Hidroclever
Magnetized vinyl. Hydroclever image
Vinyle aimanté. Image de hidroclever

Ref.	€	📦
95671	70,00	1
95664	55,00	1
95665	52,00	1
95666	52,00	1
95829	52,00	1
95806	52,00	1

Fáciles de montar

Easy to assemble | Facile à assembler



Expositor Clever Maxi

Clever maxi display
Présentoir Clever maxi



CLEVER MAXI. Posibles configuraciones.

Clever maxi. Possible configurations / Clever maxi. Configurations possibles

Expositor 1



Expositor 2



Expositor 3



Expositor 4



Expositor 5



Expositor 6



Expositor 7



Expositor 8



Expositor 9



Expositor 10



	Incluye																			
	95667	95668	95669	95670	95663	95749	95756	95832	95828	95824	95839	95840	95837	95838	95664	95665	95666	95829	95806	
Expositor 1	1	8																		
Expositor 2	1	4	4																	
Expositor 3	1		2	2	4															
Expositor 4	1	1	3	1	2		1													
Expositor 5	1	2	2		4											1		1		
Expositor 6	1	1	1		4	2											1	1		
Expositor 7	1				4			1	1											
Expositor 8	1				4			1	1											1
Expositor 9	1		1				2			1	1	2	1							
Expositor 10	1	1	1							1	1	1		1						



Mikura
260



Marina
263



Bahama **Urban**
264

Off Clever

Hasta finalizar existencias

While stocks last / Jusqu'à épuisement du stock



Saona
265



Chef
265



Temporizados
Delay action
Temporisés
266



Desagües
Pop-up wastes
Vidages
266

Off Clever

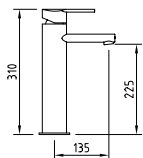

Mikura



LAVABO 225

Tall basin mixer 225 | Mitigeur lavabo 225

Mezclador alto, aireador, flexibles M-10 3/8" x 600 mm.
Tall mixer, aerator, flexible hoses M-10 3/8" x 600 mm.
Mitigeur Lavabo bec haut, aérateur, raccords flexibles M-10 3/8" x 600 mm

	Ref.	€	
 	97401	243,00	6



95154 97371 90025

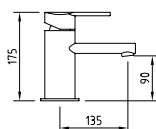

LAVABO 90

Basin mixer 90 | Mitigeur lavabo 90

Mezclador con aireador y flexibles M-10 3/8" x 370 mm.
Mixer, aerator, flexible hoses M-10 3/8" x 370 mm.
Mitigeur Lavabo, aérateur, raccords flexibles M-10 3/8" x 370 mm

	Ref.	€	
 	97400	160,00	6



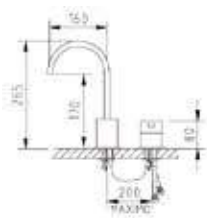

95154 97371 90025



LAVABO REPISA 170

Two hole deck Basin 170 | Mitigeur lavabo 2 trous 170

Mezclador con rompeaguas, caño giratorio.
Two hole deck basin with water breaker, swivel spout.
Mitigeur lavabo, brise-jet, bec orientable

	Ref.	€	
 	97411	194,00	4



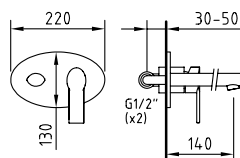

95154 97372 97381



LAVABO MURAL EMPOTRAR

Concealed wall mounted basin | Lavabo à encastrer

Mezclador empotrable mural, caño con aireador, longitud 140 mm.
Concealed wall mounted basin, spout 140 mm long, with aerator.
Mitigeur lavabo encastré, aérateur, bec 140 mm.

	Ref.	€	
 	97410	190,00	8



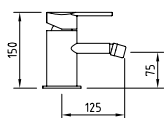

95154 97371 90025



BIDÉ

Bidet mixer | Mitigeur bidet

Mezclador con aireador a rótula y flexibles M-10 3/8" x 370 mm.
Mixer, swivel aerator, flexible hoses M-10 3/8" x 370 mm.
Mitigeur bidet, aérateur rotule, raccords flexibles M-10 3/8" x 370 mm

	Ref.	€	
 	97402	160,00	6



95154 97371 90026

BAÑO-DUCHA
Bath-shower mixer | Mitigeur bain-douche

Mezclador baño-ducha, con aireador, inversor automático.
Bath-shower mixer, with aerator, automatic diverter.
Mitigeur bain-douche, aérateur, inverseur automatique

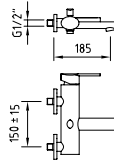

Incluye teléfono ducha, flexo y soporte
Includes handset, hose and holder
Inclus douchette, flexible et support
(97143, 97670, 96458)

Sin kit ducha
Without shower kit
Sans kit de douche

	Ref.	€	
	97403	245,00	4
	97862	215,00	4



DUCHA
Shower mixer | Mitigeur douche

Mezclador para ducha.
Shower mixer.
Mitigeur douche

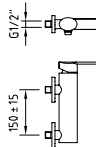

Incluye teléfono ducha, flexo y soporte
Includes handset, hose and holder
Inclus douchette, flexible et support
(97143, 97670, 96458)

Sin kit ducha
Without shower kit
Sans kit de douche

	Ref.	€	
	97404	202,00	6
	97863	172,00	4



BAÑO-DUCHA FIJACIÓN SUELO | Floor standing bath-shower mixer | Mitigeur bain-douche sur colonne avec prise d'eau au sol

Baño-ducha fijación suelo con rompeaguas, inversor automático.
Floor standing bath-shower mixer, water breaker with spout, automatic diverter.
Mitigeur bain-douche sur colonne avec prise d'eau au sol, brise-jet, inverseur automatique

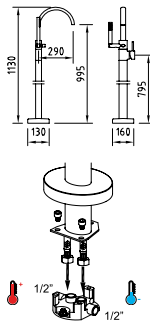

Incluye
Includes
Inclus



	Ref.	€	
	97956	690,00	4

FREGADERO
Sink mixer | Mitigeur évier

Mezclador con aireador, caño conformado giratorio, flexibles M-10 3/8" x 370 mm.
Mixer with aerator, swivel tube spout, flexible hoses M-10 3/8" x 370 mm.
Mitigeur évier bec orientable, brise-jet, raccords flexibles M-10 3/8" x 370 mm

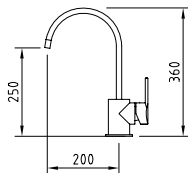

	Ref.	€	
	97405	167,00	3

BAÑO-DUCHA EMPOTRADO Y DUCHA /3 vías | Concealed bath-shower kit / 3 outlet diverter | Ensemble bain-douche à encastrer + barre / 3 voies

Mezclador empotrable para ducha, con barra de ducha metálica.
Concealed shower with metallic sliding rail kit.
Mitigeur bain-douche encastré, inverseur automatique. Avec pomme de douche, douchette et support mural

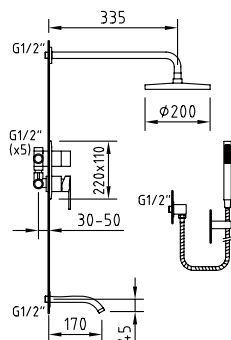

Incluye
Includes
Inclus



	Ref.	€	
	97407	619,00	4

BAÑO-DUCHA REPISA

Four hole bath-Shower | Mitigeur bain-douche 4 trous

Baño-ducha repisa con rompeaguas, caño giratorio, inversor cerámico.
Four hole bath-shower with water breaker, swivel spout, ceramic diverter.
Mitigeur bain-douche 4 trous, brise-jet, bec orientable, inverseur céramique

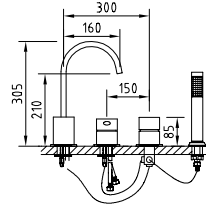

Incluye
Includes
Inclus



	Ref.	€	
ec2	97955	377,00	4

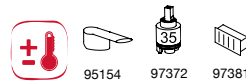

CONJUNTO DE DUCHA EXTENSIBLE 4 JETS

Extensible shower system 4 jets | Colonne mitigeur douche extensible hydromassage

Mezclador de ducha con tubo extensible, 4 jets hidromasaje y soporte integrado Mikura.

Adjustable shower system with integral diverter and body jets.
4 jets, support douchette fixe, inverseur automatique, pomme de douche, douchette et flexible

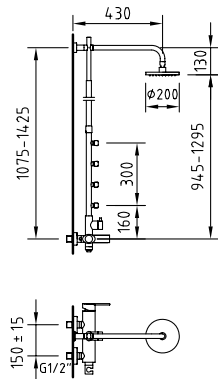

Incluye
Includes
Inclus



	Ref.	€	
ec2	97417	1.030,00	2



CONJUNTO DE DUCHA TERMOSTÁTICO EXTENSIBLE 4 JETS

Extensible thermostatic shower system 4 jets | Colonne thermostatique douche extensible hydromassage

Mezclador de ducha **termostático** con tubo extensible, 4 jets de hidromasaje y soporte articulado.

Adjustable thermostatic shower system with integral diverter and body jets.
4 jets, support douchette orientable, inverseurs céramiques, pomme de douche, douchette et flexible.

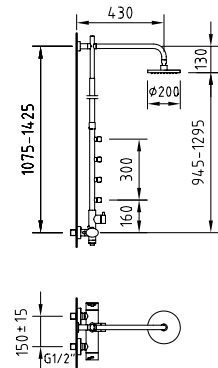

Incluye
Includes
Inclus



	Ref.	€	
	97419	1.100,00	2



Marina

LAVABO 235 | Tall basin mixer 235 | Mitigeur lavabo 235

Mezclador alto, aireador, flexibles M-10 3/8" x 370 mm.
Tall mixer, aerator, flexible hoses M-10 3/8" x 370 mm.
Mitigeur Lavabo bec haut, aérateur, raccords flexibles M-10 3/8" x 370 mm

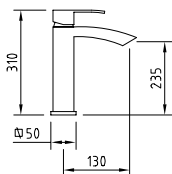

	Ref.	€	📦
	96776	243,00	6



BIDÉ | Bidet mixer | Mitigeur bidet

Mezclador con aireador a rótula y flexibles M-10 3/8" x 370 mm.
Mixer, swivel aerator, flexible hoses M-10 3/8" x 370 mm.
Mitigeur bidet, aérateur rotule, raccords flexibles M-10 3/8" x 370 mm

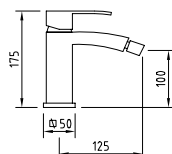

	Ref.	€	📦
	96777	182,00	8



BAÑO-DUCHA | Bath-shower mixer | Mitigeur bain-douche

Mezclador baño-ducha, con aireador, inversor automático.
Bath-shower mixer, with aerator, automatic diverter.
Mitigeur bain-douche, aérateur, inverseur automatique

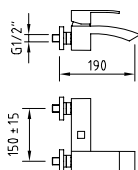

Incluye teléfono ducha, flexo y soporte
Includes handset, hose and holder
Inclus douchette, flexible et support
(96786, 97670, 96413)

	Ref.	€	📦
	96778	283,00	6



DUCHA | Shower mixer | Mitigeur douche

Mezclador para ducha.
Shower mixer.
Mitigeur douche

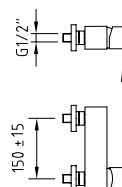

Incluye teléfono ducha, flexo y soporte
Includes handset, hose and holder
Inclus douchette, flexible et support
(96786, 97670, 96413)

	Ref.	€	📦
	96779	209,00	8



GRIFERÍA PARA DUCHA - 1 Vía Wall mounted shower mixer - 1 outlet diverter Douche à encastrer - 1 voie

Mezclador empotrable de 1/2" para ducha.
Concealed shower kit 1/2".
Douche à encastrer 1/2".

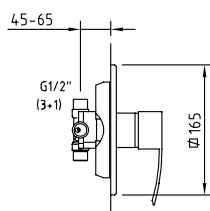

	Ref.	€	📦
	98444	185,00	8



Bahama urban

LAVABO 55 | Basin mixer 55 | Mitigeur lavabo 55

Mezclador con aireador y flexibles M-10 3/8" x 370 mm.
Mixer, aerator, flexible hoses M-10 3/8" x 370 mm.
Mitigeur Lavabo, aérateur, raccords flexibles M-10 3/8" x 370 mm

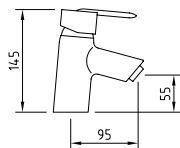

	Ref.	€	
	ec1 93528	73,00	12



BIDÉ | Bidet mixer | Mitigeur bidet

Mezclador con aireador a rótula y flexibles M-10 3/8" x 370 mm.
Mixer, swivel aerator, flexible hoses M-10 3/8" x 370 mm.
Mitigeur bidet, aérateur rotule, raccords flexibles M-10 3/8" x 370 mm

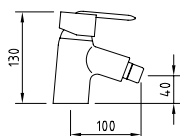

	Ref.	€	
	ec1 93529	73,00	12



BAÑO-DUCHA | Bath-shower mixer | Mitigeur bain-douche

Mezclador baño-ducha, aireador, inversor automático
Bath-shower mixer, aerator, automatic diverter.
Mitigeur bain-douche, aérateur, inverseur automatique

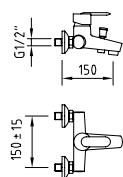

Incluye teléfono ducha, flexo y soporte
Includes handset, hose and holder
Inclus douchette, flexible et support
(96108,97670, 90011)

	Ref.	€	
	ec1 93530	135,00	8

Sin kit ducha
Without shower kit
Sans kit de douche

	Ref.	€	
	ec1 97917	115,00	8

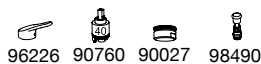

DUCHA | Shower mixer | Mitigeur Douche

Mezclador para ducha.
Shower mixer.
Mitigeur douche

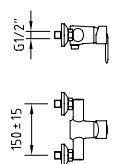

Incluye teléfono ducha, flexo y soporte
Includes handset, hose and holder
Inclus douchette, flexible et support
(96108,97670, 90011)

	Ref.	€	
	ec1 93531	102,00	8

Sin kit ducha
Without shower kit
Sans kit de douche

	Ref.	€	
	ec1 97918	82,00	8



FREGADERO | Sink mixer | Mitigeur Évier

Mezclador con aireador, caño conformado giratorio y flexibles M-10 3/8" x 420 mm.
Mixer, aerator, swivel tube spout flexible hoses M-10 3/8" x 420 mm.
Mitigeur évier bec orientable, aérateur, raccords flexibles M-10 3/8" x 420 mm

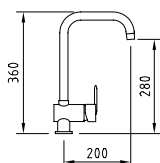

	Ref.	€	
	ec1 96090	143,00	8

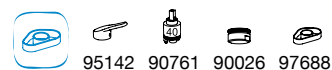

Saona

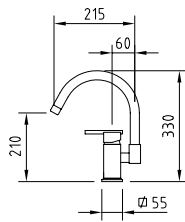

FREGADERO | Sink mixer | Mitigeur évier

Mezclador con aireador, caño giratorio, flexibles M-10 3/8" x 370 mm.
Mixer with aerator, swivel spout, flexible hoses M-10 3/8" x 370 mm.
Mitigeur évier bec orientable, raccords flexibles M-10 3/8" x 370 mm.

Ref.	€	📦
ACS 96028	154,00	6



96218 96205 90026 97688

Chef

FREGADERO COLUMNA LAVAVAJILLAS | Sink mixer with swivel spout and dishwashing shower | Mitigeur évier industriel

Fregadero columna lavavajillas, caño lateral recto con palanca, muelle resistente, ducha de pistola y flexo 47cm. Flexibles M-10 3/8" x 370 mm.
Sink column, straight lateral spout, diverter, strong spring, dishwashing shower, hose 47cm. Flexible hoses M-10 3/8" x 370 mm.
Évier à bec orientable, ressort de guidage renforcé, douchette avec gachette pré-lavage. Livré avec raccords flexibles M-10 3/8" x 370 mm

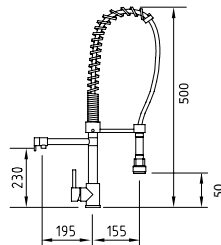

	Ref.	€	📦
500 mm	ec1 96771	410,00	4



95158 90761 96273 97688 90026

FREGADERO COLUMNA LAVAVAJILLAS | Sink mixer with swivel spout and dishwashing shower | Mitigeur évier industriel

Fregadero columna lavavajillas, muelle resistente y ducha de pistola. Flexibles M-10 3/8" x 370 mm.
Sink column, strong spring, dishwashing shower. Flexible hoses M-10 3/8" x 370 mm.
Évier à bec orientable, ressort de guidage renforcé, douchette avec gachette pré-lavage. Livré avec raccords flexibles M-10 3/8" x 370 mm

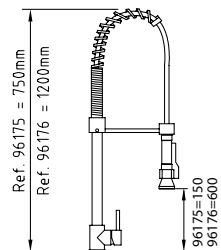

	Ref.	€	📦
750 mm	ec1 96175	441,00	4
1200 mm	ec1 96176	467,00	4



95158 90761 96273 97688

FREGADERO COLUMNA LAVAVAJILLAS 500 | Sink mixer with swivel spout and dishwashing shower | Mitigeur évier douchette

Fregadero columna lavavajillas, muelle resistente y ducha extraíble de pistola con 2 posiciones. Flexibles M-10 3/8" x 370 mm.
Wash-dishes sink column, strong spring and pull-out dishwashing shower. Flexible hoses M-10 3/8" x 370 mm.
Évier à bec orientable, ressort de guidage renforcé, douchette avec poussoir pré-lavage. Livré avec raccords flexibles M-10 3/8" x 370 mm

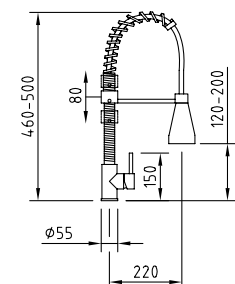

	Ref.	€	📦
500 mm	ec1 96755	255,00	4



95145 96205 97364 97688

Temporizados | Delay action taps | Temporisés

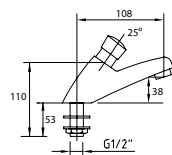

GRIFERIA TEMPORIZADA | Delay action basin tap | Robinet temporisé

Grifo de repisa para lavabo, con aireador, 14 segundos, cartucho M28
Deck mounted basin tap, with aerator, 14 seconds, cartridge M28
Robinet simple, avec aérateur, 14 secondes cartouche M28

Ref.	€	
98923	35,00	40

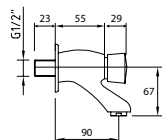

GRIFERIA TEMPORIZADA MURAL | Wall mounted delay action basin tap | Robinet temporisé mural

Grifo mural para lavabo, con aireador, 14 segundos, cartucho M28
Wall mounted basin tap, with aerator, 14 seconds, cartridge M28
Robinet simple, avec aérateur, 14 secondes cartouche M28

Ref.	€	
98924	30,00	40

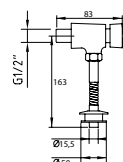

GRIFERIA TEMPORIZADA URINARIO MURAL | Wall mounted urinal flush valve | Robinet temporisé urinoir mural

Fluxor de 1/2" para urinario, 7 segundos, cartucho M28.
Urinal 1/2" fluxor, 7 seconds, cartridge M28.
Robinet temporisé urinoir mural 1/2", 7 secondes, cartouche M28.

Ref.	€	
98925	24,70	40



Desagües | Pop-up | Vidages



LEO

VÁLVULA DESAGÜE SISTEMA QUICK-CLAC | Basin click waste | Vidage quick-clac

Válvula desagüe Universal. Sintético
Universal drain quick-clac. Synthetic
Vidage Universel. Synthétique

Ref.	€	
NF 99398	12,00	1



93528
Lavabo 55
Basin mixer 55
Mitigeur lavabo 55



93528
Lavabo 55
Basin mixer 55
Mitigeur lavabo 55

OFF

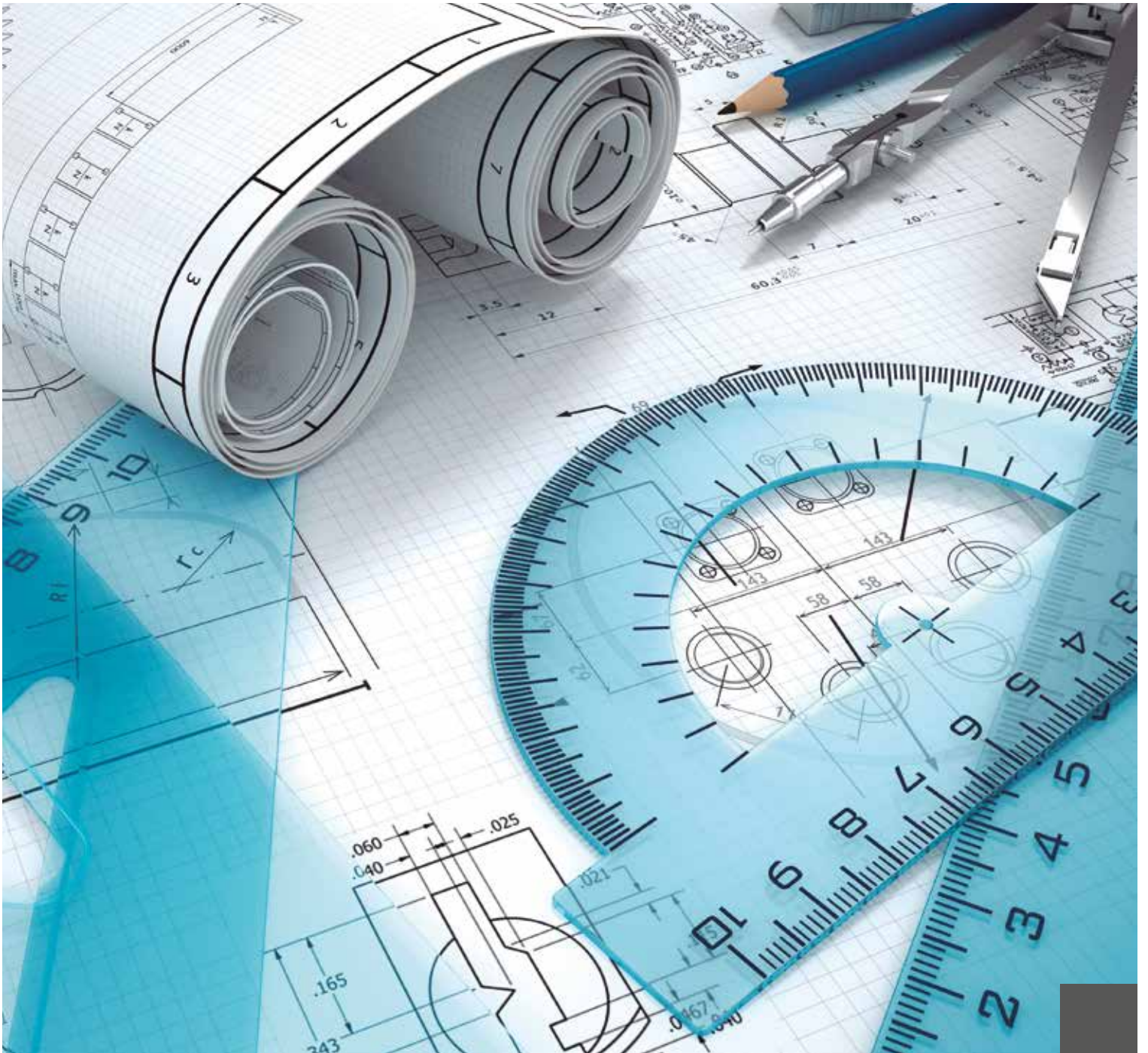

Información técnica y certificados

Technical information and certificates
Information technique et certificats

Información técnica

Technical information
Information technique

270

Certificados

Certificates
Certificats

282

LATÓN · BRASS · LAITON

FUNDIDO · CAST · FONTE



La grifería Clever utiliza aleaciones puras, con una mínima cantidad de impurezas.
El porcentaje de plomo es muy bajo ($Pb < 1,6\%$) en consonancia con las directrices de consumo de agua potable.
La aleación exenta de poros logra un pulido de alta calidad.
Ausencia total roturas.

Clever taps use pure alloys, with a minimum impurity quantity.
The percentage of lead is really low ($Pb < 1,6\%$) according to the strictest market requirements. The alloy exempts of pores allows to obtain a high quality polish.
Total breaks Absence.

La robinetterie Clever est fabriquée à partir d'alliages purs, à très faibles niveaux d'impuretés.
Très faibles pourcentage de plomb ($Pb < 1,6\%$) selon les exigences les plus strictes concernant la consommation d'eau potable.
Les alliages sans pores permettent un polissage de haute qualité.
Sans aucune fissure.

ESTAMPACIÓN · STAMPING · ESTAMPÉE



Latón europeo estampado de extrusión de primera calidad. Norma UE EN 12.164/5. El latón de estampación contiene un porcentaje muy alto de cobre ($Cu \sim 60\%$).
El porcentaje de estaño es muy bajo ($Sn < 0,3\%$), evitando la rigidez y posibles daños.

High quality European stamping Brass. According rule UE EN 12.164/5. The stamping brass has a high percentage of Cooper ($Cu \sim 60\%$).
Very low percentage of Tin ($Sn < 0,3\%$), avoids rigidity and possible damages.

Laiton européen estampé par extrusion, de première qualité. Norme UE-EN 12.164/5.
Le laiton estampé contient un fort pourcentage de cuivre ($Cu \sim 60\%$).
Très faible pourcentage d'étain ($Sn < 0,3\%$), évitant la rigidité et les possible endommagements.

COMPONENTES · COMPONENTS · COMPOSANTS

LATIGUILLOS · HOSE BIBS · FLEXIBLES



Longitud de 370 mm, según Norma EN 817. Macho roscado fabricado con CW617 ($Sn < 0,3\%$).
Trenzado acero Inoxidable AISI 304. Tubo de goma EPDM o PEX, libre de migración de partículas nocivas.
Amplia cobertura de certificaciones internacionales. Resisten presiones estáticas de más de 130 bar (13 MPa).

Length 370 mm according to the rule EN 817. Male nut produced with CW617 ($Sn < 0,3\%$).
Braided stainless steel AISI 304. Rubber tube EPDM or PEX, avoiding any particles migration.
All worldwide certifications. They resist static pressures higher than 130 bars (13MPa).

Longeur 370 mm. suivant la norme EN 817. Fabriqué avec CW617 ($Sn < 0,3\%$).
Tressé en acier inoxydable AISI 304. Tuyau en caoutchouc EPDM o PEX, sans migration de particules nocives.
Tous types de certifications mondiales. Supportent des pressions statiques de plus de 130 bar (13 MPa).

AIREADORES · AERATORS · AÉRATEURS



NEOPERL®

Protección máxima contra los residuos de cal. Período de vida de larga duración.
Reducción de salpicaduras. Control de rectitud de la corriente y el diámetro del chorro de agua.
Producen un flujo recto, redondo, independiente de la presión.
Nivel de ruido mínimo. Permiten un ahorro de agua y reducen el coste energético.

Maxim protection against lime residues. Long life.
Splashes reduction. Flow straight control and water stream diameter.
It produces a straight flow, round, independent to the pressure.
Minimum noise level. It allows water save and electricity cost reduction.

Haute protection contre le tartre. Retarde l'apparition d'incrustations calcaires.
Longue période de vie. Réduction des éclaboussures.
Rectitude du courant et du diamètre indépendamment de la pression.
Niveau minimal de bruit. Permettent l'économie d'eau et la réduction du coût énergétique.

CROMADO · CHROMED · CHROMÉ



Extra Cromado, proceso de cromado compuesto por 44 pasos que garantizan la resistencia a la corrosión.
La superficie debe resistir una prueba de laboratorio que consiste en soportar más de 200 horas de niebla salina sin que se aprecien defectos.

Extra Chromed, our Chrome process is composed by 44 steps to warranty the corrosion resistance.
The surface has to resist the laboratory test which consists of withstanding > 200 hours salt spray test without appearing any defect.

Extra Chrome, procédé de chromage en 44 étapes qui garantissent la résistance à la corrosion.
La surface doit être capable de supporter des essais en laboratoire equivalents à 200 heures de brouillard salin, sans endommagements appréciables.



EXCÉNTRICA · ECCENTRIC NUT · RACCORD EXCENTRÉ

El diseño interior evita ruidos procedentes de la circulación del agua. Fabricado con CW617 (Sn<0.3%)
Un dispositivo instalado en el interior de la excéntrica absorbe el ruido del agua al pasar por ella.
Reduce el ruido alrededor de 20 decibelios.

The inner design avoids noises from the water circulation. Produced with CW617 (Sn<0.3%)
One set installed inside the eccentric nut absorbs the noise when the water flows.
Noise reduction around 20 decibels.

Sa conception intérieure évite les bruits de la circulation d'eau. Fabriqué avec CW617 (Sn <0,3%). Un dispositif absorbe le bruit de l'eau à son passage par l'excentré.
Réduit le bruit de 20 db. approx.



GARANTÍA CLEVER · WARRANTY · GARANTIE

Los grifos Clever han pasado estrictos controles de calidad, están fabricados con los mejores materiales y componentes con el fin de ofrecer confort y durabilidad. Es por ello que ofrecemos 5 años de garantía en TODA nuestra gama. Temporizados, 2 años.
La grifería Clever cumple con las indicaciones de las normas: UNE 19-703 / UNE 19-707 (EN 200) / UNE-EN 817 / UNE-EN 816 / UNE-EN 111, y su calidad está garantizada según la norma ISO 9001.

Clever taps have passed the strictest quality controls as all are produced with the best materials and components in order to offer the comfort and durability. Due to reason we offer 5 years guarantee in all our ranges. Delay action taps 2 years.
Clever taps carry out the following rules: UNE 19-703 / UNE 19-707 (EN 200) / UNE-EN 817 / UNE-EN 816 / UNE-EN 111, and its quality is guaranteed according to ISO 9001.

La robinetterie Clever a été soumise aux plus stricts contrôles de qualité et fabriquée à partir des meilleurs matériaux et composants.
Ceci nous permettant d'offrir 5 ans de garantie pour TOUTE la gamme. Temporisés 2 ans.
La robinetterie Clever est soumise aux normes: UNE 19-703/ UNE 19-707 (EN 200)/ UNE EN 817/ UNE EN 816/ UNE EN 111 et sa qualité est garantie selon la norme ISO 9001.



Standard

cosedal

gitec

QUORE



Se incorporan cerámicas técnicas sintetizadas de alta precisión con **gran resistencia al desgaste**. Todos los materiales en contacto con el agua cumplen las normas internacionales sanitarias como ACS, KTW & W270, Watermark, etc. La gran sensibilidad, nos confiere en la maneta un largo desplazamiento lateral entre 34° y 42°. Lo que nos permite obtener la temperatura deseada con exactitud.

The cartridge uses high advanced sintered ceramic disc with high resistance to wear. All material in contact with water is certified by international norms such as ACS, KTW & W270, Watermark, etc. The sensibility of the handle allows us to get the temperature with exactitude.

Nous avons incorporé des céramiques techniques synthétisées de haute précision, avec une grande résistance à l'usure. Tous les matériaux en contact avec l'eau sont conformes aux normes sanitaires comme l'ACS, la KTW et la W270, Watermark, etc. L'ampleur de déplacement latéral de la manette entre 34° et 42° nous permet d'obtenir la température souhaitée avec la plus grande exactitude.

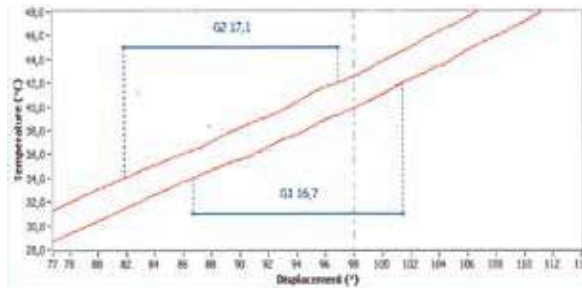

ec1

El sistema **EcoNature** consiste en un cartucho con 2 posiciones, calibrado desde fábrica, el cual ofrece un alto nivel de confort y facilidad de uso. El sistema se basa en un mecanismo situado en el interior del cartucho.

Con un suave gesto suministra el **caudal necesario** para el uso cotidiano del grifo (ahorrando aproximadamente un 50% en el consumo de agua), si se desea el máximo caudal hay que ejercer una ligera presión en la palanca hacia arriba hasta alcanzar el máximo recorrido de la maneta.

*The **EcoNature** system consists of an Economizer Cartridge with two positions, assembled and calibrated in the factory, which offers a high level of comfort and it is very easy to use.*

*The system is based on an end located in the interior of the cartridge, with a smooth gesture provides the **volume necessary** to guarantee a sufficient water flow for the daily use (saving approximately a 50% in the water consumption), if the maximum volume is desired it is only necessary to rise the handle till the maximum position.*



Sistema EcoNature, EcoNature system

*L'**EcoNature** système consiste à utiliser une cartouche céramique de dernière génération équipée d'un système à 2 positions d'ouverture, assemblé et calibré en usine. Ce système permet de réelles économies d'eau et offre un grand confort d'utilisation.*

Son principe de fonctionnement repose sur un dispositif d'arrêt de course du levier, localisé à l'intérieur de la cartouche et qui permet d'obtenir un débit d'eau suffisant pour une utilisation quotidienne (50% d'économie dans la consommation d'eau).

Si le débit maximum est nécessaire, il suffit de lever le levier jusqu'à sa position maximum.

EcoNature

cosedal

gitec



ec2

EcoNature + ColdOpen

gitec



El cartucho ec3 además de incorporar el sistema EcoNature también incorpora ColdOpen, apertura en frío. Con este tipo de apertura obtendremos un ahorro no sólo en caudal, gracias al EcoNature, sino que también en agua caliente gracias a que la maneta, en su posición central, genera agua fría evitando la mezcla de caliente y fría y por lo tanto, consiguiendo un ahorro.

The ec3 cartridge apart from having Econature system also incorporates ColdOpen function, this means opening in cold. With this type of opening we get a saving not only in flow, thanks to Econature, also in hot water due to the handle in its central position that generates cold water, avoiding to mix hot and cold water from the beginning.

En plus du système EcoNature, la cartouche ec3 intègre le système ColdOpen, ouverture eau froide. Avec ce type d'ouverture, nous obtenons une économie non seulement de débit, grâce à l'EcoNature, mais aussi d'eau chaude puisque la manette, lorsqu'elle est actionnée en position centrale, ne libère que de l'eau froide sans la mélanger avec l'eau chaude, permettant ainsi une économie importante.

ec3



Sistema EcoNature, EcoNature system

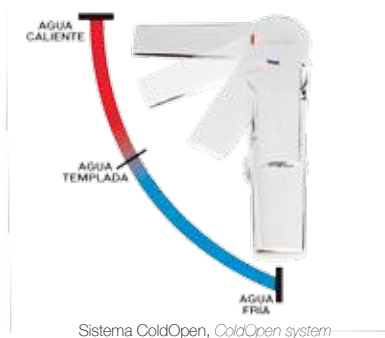

Sistema ColdOpen, ColdOpen system

Termostático

Estabilidad: la temperatura permanece constante. **Confort:** compensa automáticamente los cambios de temperatura. **Seguridad:** si el suministro de agua fría se interrumpe, el cartucho no deja pasar agua caliente de inmediato y evita quemaduras. **Precisión:** grifos calibrados a 38°C. **Temperatura exacta.** **Exactitud:** cartucho sintético especial, insensible a la cal (Ca). **Trazabilidad:** marcado STH y fecha para un mayor control y seguimiento.

Stability: the temperature remains constant. Comfort: automatically compensates temperature changes. Safety: If the cold water supplied is interrupted, the cartridge will not let hot water to enter and avoid scalding. Accuracy: taps calibrated at 38 ° C. Exact Temperature. Exactitude: special synthetic cartridge, insensitive to the lime (Ca). Traceability: STH brand and date marked for a higher control and monitoring.

Stabilité: la température reste constante. Confort: les changements de température sont compensés automatiquement. Sécurité: en cas d'interruption du débit d'eau froide, la cartouche ne laisse pas passer l'eau chaude immédiatement, évitant ainsi les brûlures. Précision: les robinets sont calibrés à 38°. Température exacte. Résistance: cartouche synthétique spéciale, résistante au calcaire (Ca). Traçabilité: marquage STH et datage pour un meilleur contrôle et suivi.



cosedal





SEGURIDAD · SECURITY · SÉCURITÉ



TERMOLIMIT

Limitación temperatura
Temperature limit
Limitation de la température



Anillo situado en el cartucho que permite al usuario limitar la temperatura del agua caliente, consiguiendo ahorro energético y evitando quemaduras. Ideal para la seguridad infantil.

O-ring placed in the cartridge, which allows the end user limit the hot water temperature, saving electricity and avoiding scalds.

It is worth for the child security.



Un anneau situé sur la cartouche permet à l'utilisateur de limiter la température de l'eau chaude, obtenant ainsi une économie d'énergie et évitant les brûlures. Idéal pour la sécurité des enfants.



MEDICAL

Máxima higiene
Maximum hygiene
Hygiène maximale

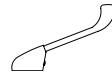

La maneta gerontológica Clever es ideal para ubicaciones dónde los requerimientos higiénicos sean elevados. Además el usuario puede montarla en otros grifos Clever. Consultar compatibilidad con nuestro servicio técnico al cliente.

The Clever hygienic handle is suitable for those places where the hygienic requirements are high. Moreover the end user can assembly this handle in other Clever taps. Please check with our Technical Department if it suits.

La manette hygiénique Clever, comme son nom l'indique, est particulièrement adaptée aux endroits où les normes d'hygiène sont élevées.

De plus l'utilisateur peut monter cette manette sur les autres mitigeurs Clever. Merci de vous rapprocher de notre Département Technique pour vérifier les compatibilités.



SAFETY BLOCK

Doble tope de seguridad para termostáticos
Double security system for thermostatic
Double système de sécurité pour thermostatique

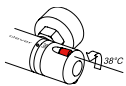

Dispositivo que evita temperaturas superiores a 38°C de manera involuntaria. El usuario debe pulsar el botón para conseguir temperaturas superiores. Ideal para la seguridad infantil. Bloqueo automático en el caso de que se interrumpa el suministro de agua fría en la instalación.

Mechanism which avoids temperatures higher than 38°C in an involuntary way. The end user has to press the button in order to get higher temperatures.

It is perfect for the child security. Automatic block in case it is stopped the cold water supply.

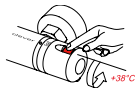

Mécanisme qui évite une température involontairement supérieure à 38°. L'utilisateur doit presser le bouton afin d'avoir des températures plus élevées. Idéal pour la sécurité des enfants. Blocage automatique en cas de baisse de pression sur le réseau d'eau froide.



MEDIO AMBIENTE · ENVIRONMENT · ENVIRONNEMENT



PUBLIC PLACE

Diseñado para lugares públicos
Designed for public places
Conçu pour les lieux publics



Las gamas de Temporizados Clever están específicamente diseñados para lugares públicos. Automático, antivandálico, sistema inteligente de ahorro de agua y sistema de desmontaje oculto.

The series Clever of Delay Action are specially designed for Public Places.

Automatic, antivandalic, wise system to save water and hidden dismantle system.

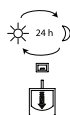

Les séries Temporisées sont spécialement conçues pour les lieux publics. Automatique, antivandalisme, système intelligent d'économie d'eau et système de démontage caché.



RECICLABLE

Ecológico
Ecologic
Ecologique



Clever utiliza material de embalaje reciclable en toda su gama, consciente del medio ambiente. El proceso de fabricación es inspeccionado periódicamente, asegurando la conservación de la naturaleza.



Clever uses recycle packaging in all its range, protecting the environment. The production process it is inspected periodically, safeguarding the nature conservation.

Clever protège l'environnement en utilisant des matériaux recyclés pour tous ses packagings. Ce système de production mis en place pour préserver la nature est inspecté périodiquement.



NOISELESS

Dispositivo reductor de sonido
Noise reduction system
Système de réduction du bruit

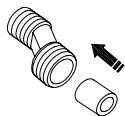

El diseño interior de nuestra grifería evita que el agua a su paso produzca ondas sonoras.
Un dispositivo ubicado en las excéntricas absorbe las ondas sonoras de las aguas recibidas por la instalación.

The inner design of our taps avoid noises from the water circuit.
A mechanism placed inside our eccentric nut absorbs the noises produced when the water goes through the tap.

Le design interne de nos modèles évite tout bruit provenant du circuit de l'eau.
Un mécanisme placé à l'intérieur de notre raccord excentrique absorbe les bruits produits par l'écoulement de l'eau sur le réseau.



WATER REDUCE

Sistema reducción de caudal
Flow reduction system
Système de réduction de débit



Los dispositivos reductores proporcionan un ahorro significativo del consumo de agua en grifos y mangos de ducha.
El caudal máximo se verá reducido a 9 litros x minuto.

The reducing devices provide a significant water saving consumption in taps and shower handles. The maximum volume will be reduced to 9 liters x minute.

Les dispositifs réducteurs offrent une économie significative de la consommation d'eau pour les robinets et les douchettes. Le débit maximum est réduit à 9 litres x minutes.



PURE H₂O

Grifería para osmosis
Filter sink mixer
Robinet eau pure osmosis

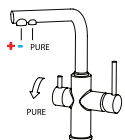

Un grifo con 2 salidas: agua corriente y agua pura de ósmosis.

Mixer with two exits: tap and filter water.

Un robinet avec deux sorties: eau courante et eau purifiée.

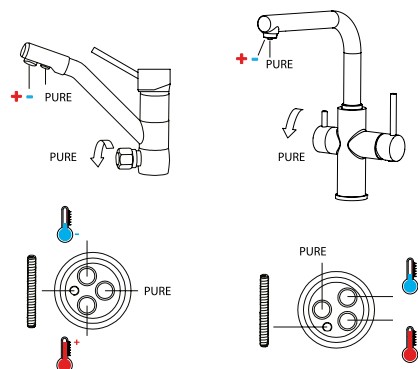

TECNOLOGÍA · TECHNOLOGY · TECHNOLOGIE

ec1
Cartucho ec1
ec1 cartridge
Cartouche ec1

Se incorporan cerámicas técnicas sintetizadas de alta precisión con gran resistencia al desgaste. Todos los materiales en contacto con el agua cumplen las normas internacionales sanitarias como ACS, KTW & W270, Watermark, etc.

Synthesized high precision technical ceramics with high resistance to the corrosion are incorporated. All materials in contact with water complied with international standards such as sanitary ACS, KTW & W270, Watermark, etc.

Nous avons incorporé des céramiques techniques synthétisées de haute précision, avec une grande résistance à l'usure. Tous les matériaux en contact avec l'eau sont conformes aux normes sanitaires comme l'ACS, la KTW et la W270, Watermark, etc



ec2
Cartucho ec2
ec2 cartridge
Cartouche ec2

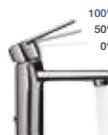

El sistema EcoNature consiste en un cartucho con 2 posiciones, calibrado desde fábrica, el cual ofrece un alto nivel de confort y facilidad de uso. El sistema se basa en un mecanismo situado en el interior del cartucho.

The Econature system consists on a cartridge with 2 positions, calibrated at the factory, which offers a high level of comfort and ease use. The system is based on a mechanism located inside the cartridge.

L'EcoNature système consiste à utiliser une cartouche céramique équipée d'un système à 2 positions d'ouverture, assemblée et calibrée en usine. Ce système permet de réelles économies d'eau et offre un grand confort d'utilisation.



ec3
Cartucho ec3
ec3 cartridge
Cartouche ec3



El cartucho ec3 además de incorporar el sistema EcoNature también incorpora ColdOpen, apertura en frío. Consiguiendo un ahorro en agua caliente gracias a que la maneta, en su posición central, genera agua fría evitando la mezcla de caliente y fría.

The ec3 cartridge a part from having Econature system also incorporates ColdOpen function, this means opening in cold. Achieving savings in hot water thanks to the lever in the center position, it generates cold water avoiding any mixing.

En plus du système EcoNature, la cartouche ec3 intègre le système ColdOpen, ouverture eau froide. Avec ce type d'ouverture, nous obtenons une économie non seulement d'eau, grâce à l'EcoNature, mais aussi d'énergie.



WATERFALL
Efecto cascada
Waterfall effect
Effet cascade

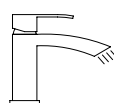

El efecto WATERFALL proporciona un cambio en la concepción de la grifería.
Sin aireador, el grifo realza su estética y reproduce la fuerza intacta de la naturaleza.

Effect WATERFALL provides a change in the taps conception. Without aerator, the faucet heightens its aesthetic one and reproduces the intact force of the nature.

L'effet WATERFALL modifie le concept de la robinetterie traditionnelle.
Sans aérateur, l'esthétique du robinet est rehaussé, la force de la nature est reproduite.



AIR FORCE
Aireadores de última generación
Last generation aerators
Aérateurs de dernière génération

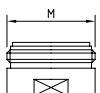

Clever utiliza aireadores de última generación y de prestigiosa firma internacional. El aireador mezcla aire y agua evitando salpicaduras. El ahorro de agua está asegurado.

Clever uses in all ranges last aerators generation and prestigious international company. The aerator mix air and water. It avoids the splashes on the washbasin. The water saving is assured.

Clever utilise pour toutes ses gammes des aérateurs de dernière génération, de prestigieuses entreprises internationales. L'aérateur mélange l'air et l'eau et permet d'éviter les projections sur le lavabo et sur les autres surfaces. L'économie d'eau est assurée.



PULL-OUT
Grifería extraíble
Pull-out taps
Robinetterie extractible

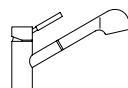

Grifería de cocina con mango extraíble.

Mixer with pull-out spout.

Robinet d'évier à douchette extractible.



SUPERFIX
Anti-movimiento para fregaderos
Stop movement for sink mixer
Renfort pour éviers



Los grifos de cocina Clever disponen de una base que se coloca en la parte inferior de los fregaderos de acero inoxidable, evitando el movimiento del grifo al accionarlo.

The Clever sink taps have available a base which is placed in the inferior part of the stainless steel taps, not allowing the mixer's movement.

Les robinets d'évier Clever disposent d'une base qui se place sur la partie inférieure des éviers en acier inoxydable, évitant ainsi la déformation de l'évier.



EASY FIX
Fácil instalación de fregaderos
Easy sink taps instalation
Facilité d'installation des éviers

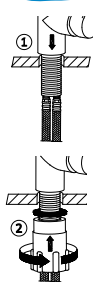

Dispositivo que permite el montaje con la mano, sin la necesidad de emplear herramientas.

Device that allows the assembly by hand, without any tools.

Dispositif qui permet le montage sans besoin d'outil spécifique.



MIRROR EFFECT
Pulido espejo
Mirror effect
Polissage miroir

El desbaste y pulido de la gama VENTU, MARINA EVO y SELENE se realiza mediante tecnología CNC, obteniendo una planicidad de efecto espejo.

The surface polished for VENTU, MARINA EVO and SELENE range is produced using the CNC technology, getting perfect flat sides with mirror effect.

L'application de la technologie CNC au dégrossissage et polissage de la gamme VENTU, MARINA EVO et SELENE permet l'obtention d'une surface plane à effet miroir.



ANTISPLASH SYSTEM
Anti salpicaduras
Anti-splash
Anti-éclaboussures

Clever ha desarrollado un sistema que disminuye las salpicaduras para fregaderos sin aireador.

Clever has developed a system which reduces the splashes when using sinks without aerator.

Clever a développé un système qui diminue les éclaboussures des éviers dépourvus d'aérateur.



CERAMIC CONTROL
Discos cerámicos
Ceramic disc
Disques céramiques

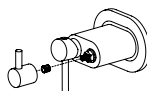

Las monturas ON-OFF son de giro 90° con discos cerámicos, óxido de aluminio de pureza 99%, indeseables. Para disminuir la conducción calorífica se monta un aislante térmico para evitar las quemaduras al accionar el pomo.

The headwork ON-OFF have a 90° turn with ceramic discs, aluminum oxide with a 99% purity, surviving the time going. In order to reduce the high temperature, a thermal insulator it is assembled to avoid scalding when you touch the handle.

Les disques ON-OFF pivotent à 90° sur disque céramique, oxyde d'aluminium pur 99%, inusable dans le temps. Pour diminuer la conduite de la chaleur et les brûlures durant l'usage, un isolant thermique est monté.



ANTI CAL
Dispositivo anti-cal
Anti lime
Dispositif anticalcaire



Todos los elementos en contacto con el agua utilizados por nuestra grifería son de materiales anti calcáreos. Se evita la obstrucción de mecanismos y la disminución de presión, y también el deterioro o el propio desperfecto de la grifería.

All the elements used in our taps which are in contact with the water are anti lime. We avoid obstruct mechanisms and water reduction, and also deteriorate or damage itself the mixer.

Tous les éléments en contact avec l'eau utilisés pour notre robinetterie sont en matière anticalcaire. L'obstruction des sorties d'eau est évitée.



HIDE DIVERTER
 Inversor diseño
 Design diverter
 Inverseur Design



Las series VENTU, MARINA EVO, AUDE, ARTIC URBAN y CAIMAN XTREME utilizan un inversor innovador, mezclando estética y funcionalidad, dónde el pomo inversor es invisible. El accionamiento consiste en desplazar el flexible de forma vertical para efectuar el cambio.

The series VENTU, MARINA EVO, AUDE, ARTIC URBAN and CAIMAN XTREME uses a new diverter, mixing style and function, where the diverter is hidden.

When the hose bib is pulled out vertically you do the change.



Les nouvelles séries VENTU, MARINA EVO, AUDE, ARTIC URBAN et CAIMAN XTREME brevetées utilisent un inverseur innovateur, mélange d'esthétisme et de fonctionnalité, où l'inverseur est invisible. Pour l'actionner, il suffit de tirer le flexible de douche vers le bas.



JET MASSAGE
 Grifería con jets de hidromasaje
 Mixer with hydromassage jets
 Robinetterie à jets hydromassants

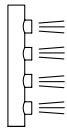

La gama MIKURA permite orientar los jets. Aconsejamos mirar con detalle las medidas de los extensibles, a fin de colocar los jets en la altura correcta.

Range MIKURA allows to position the jets. We advise to see carefully the extensible bars measures, in order to place jets in the correct height.

Confort et plaisir, une valeur ajoutée à notre robinetterie. La gamme MIKURA dispose de jets orientables. Nous conseillons de toujours bien vérifier les cotes du produit, afin de placer les jets à bonne hauteur.



EXTRA LENGHT
 Flexible 1,75m
 Hose bib 1,75 m
 Flexibles 1,75m

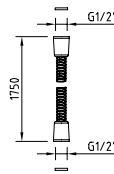

Clever utiliza flexibles de 1,75m de longitud en todos sus extensibles, duchas y baños duchas. Útil para personas de todas las estaturas.

Clever uses 1,75m hose bib length, for all showers, bath-showers. Useful for people all heights.

Clever utilise des flexibles de 1,75 m de longueur pour tous ses modèles de douches et bains-douches. Adapté aux personnes de toutes statures.



COLD TOUCH
 Grifería anti-quemaduras
 Anti-scald
 Robinetterie anti-brûlures

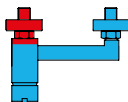

El diseño especial de nuestras duchas y baño-ducha con COLD TOUCH, permiten que en ningún caso el cuerpo se caliente y queme. Ideal para la seguridad infantil.

The special design in our Showers and Bath-Showers with COLD TOUCH, makes that the body will not have temperature and will not scald. Ideal for the child security.

Le design spécial COLD TOUCH évite que les corps de nos douches et bains douches ne chauffent et ne brûlent. Idéal pour la sécurité des enfants.

THERMOSTATIC COLD TOUCH



98823 - 98478 NINE



STANDARD SYSTEM

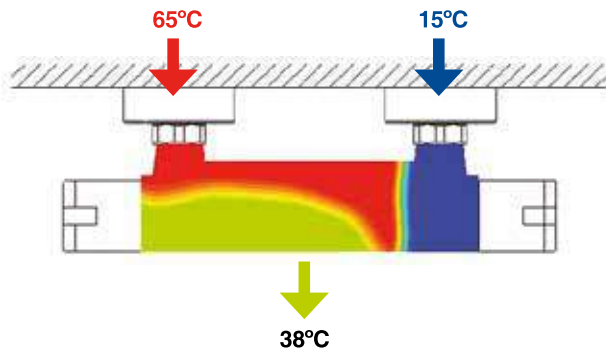

COLD TOUCH SYSTEM

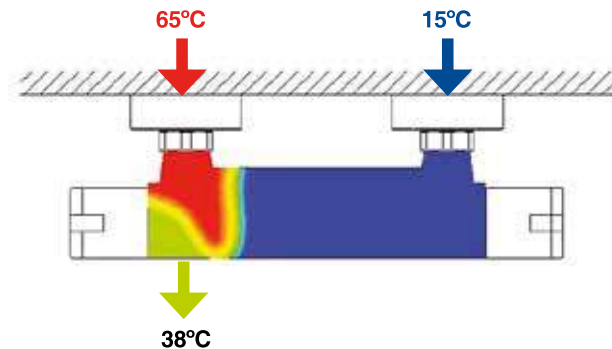



ORIENTABLE
Aireador orientable
Easy sink taps instalation
Aérateur orientable

Aireador que permite orientar el chorro de agua hasta la dirección deseada, consiguiendo así un mayor confort.

Aerator that allows to orientate the stream of water to the desired direction, thereby achieving a greater comfort.

Aérateur qui permet d'orienter le jet de l'eau pour un meilleur confort.



ULTRA SLIM
Aireador Ultra Slim
Ultra Slim aireator
Aérateur Ultra Slim

Aireador enrasado que proporciona personalidad y elegancia al grifo.

Flush aerator providing character and elegance to the faucet.

Aérateur fin qui donne de l'elegance au robinet.



COLD OPEN
Grifería de apertura en frío. Ahorro energético
Cold Open - Energy savings
Robinetterie avec système d'ouverture en eau froide. Economie d'énergie.

El sistema Cold open permite ahorrar agua caliente gracias al funcionamiento de la maneta. En su posición central, a diferencia del resto de grifería, no mezcla agua caliente y fría sino que el agua es solo fría. Para obtener agua caliente o templada se debe girar la maneta hacia la izquierda.

The Cold open system allows to save hot water thanks to the operation of the handle. In its central position, unlike the rest of the taps, it does not mix hot and cold water, the water is only cold. To obtain hot or warm water, turn the handle to the left.

Le système Cold Open permet d'effectuer des économies d'eau chaude grâce au fonctionnement de la manette. En position centrale, à la différence des autres manettes, celle-ci ne libère que de l'eau froide, sans la mélanger à de l'eau chaude. Pour obtenir de l'eau tiède ou chaude, il faut tourner la manette vers la gauche, comme indiqué.



DISEÑO Y CALIDAD · DESIGN & QUALITY · DESIGN ET QUALITÉ



TOP WARRANTY
Garantía calidad 5 años
5 years warranty
Garantie qualité 5 ans

La grifería Clever se somete a estrictos controles de calidad, es por ello que ofrecemos 5 Años de garantía en todas nuestras gamas.

Clever taps are proved under strict quality controls, is for this reason that we offer 5 years guarantee in all our ranges.

Les produits Clever subissent des contrôles qualité stricts, nous permettant de vous offrir une garantie de 5 ans sur toutes nos gammes.



TOP WARRANTY
Garantía calidad 2 años
2 years warranty
Garantie qualité 2 ans

La grifería Clever se somete a estrictos controles de calidad, es por ello que ofrecemos 2 Años de garantía en todos nuestros accesorios.

Clever taps are proved under strict quality controls, is for this reason that we offer 2 years guarantee in all our accessories.

Les produits Clever subissent des contrôles qualité stricts, nous permettant de vous offrir une garantie de 2 ans sur tous nos accessoires.



PATENTED
Diseño exclusivo y patentado
Exclusive and patent design
Design exclusif et breveté



Patented

Clever patenta sus diseños en la entidad oficial de registros de dibujos y marcas. Es nuestra distinción y el camino hacia el futuro. Las series AUDE, ARTIC urban, PAULA, S12 elegance, xtreme y urban, PANAM xtreme, START elegance y xtreme, TOUAREG y OASIS son exclusivas para los 27 países de la Unión Europea.

Clever patents its designs at the official draws and marks registration. It is our distinction and the way towards the future. The series AUDE, ARTIC urban, PAULA, S12 elegance, xtreme y urban, PANAM xtreme, START elegance y xtreme, TOUAREG and OASIS are exclusive for the 27 UNION EUROPEAN COMMUNITY countries.

Clever brevète ses designs auprès des autorités compétentes afin de protéger ses signes distinctifs et aussi d'avancer vers le futur. Les séries AUDE, ARTIC urban, PAULA, S12 elegance, xtreme y urban, PANAM xtreme, START elegance y xtreme, TOUAREG et OASIS sont déposées dans les 27 pays de l'Union Européenne.



BAG PROTECT
Funda algodón protectora
Cotton cover bag
Housse protectrice en coton



Todas las gamas Clever disponen de una funda protectora, que además de garantizar la calidad del producto una vez llega a manos del usuario, permite proteger el grifo en su ubicación definitiva hasta que las obras hayan terminado.

All Clever ranges have a protective cover, which besides guaranteeing the product quality, once arrives at the user hands allows to protect the mixer in its definitive place till the works have been finished.

Toutes les gammes Clever ont une protection qui en plus de garantir la qualité du produit permet de protéger le mitigeur jusqu'à ce que l'installation dans son emplacement final soit terminée.



MATERIALES · MATERIALS · MATÉRIAUX

Pb < 1,6%



Sn < 0,3%

HEALTH BRASS
Bajo contenido de Plomo
Low percentage of lead
Faible teneur en plomb

El bajo contenido de Plomo en las aleaciones metálicas nos permite conservar el medio ambiente y comercializar nuestros productos en estrictos mercados.

Low lead content in the metallic alloys, it allows us to take care of the environment and also being able to sell our products to the most strict markets.

La faible teneur en plomb dans les alliages métalliques nous permet de préserver l'environnement et également de vendre nos produits sur les marchés les plus exigeants.



EXTRA CHROME
Alta calidad cromado
High quality chrome
Chromage de grande qualité

El proceso de cromado consta de 44 etapas, consiguiendo 4 capas en la superficie del latón, garantizando 200 horas de niebla salina sin presentar defecto alguno.

The Chrome plated process takes 44 stages, obtaining 4 brass coats, guarantee 200 hours salty mist without showing any damage.

Le procédé de chromage se fait en 44 étapes selon les normes les plus strictes, garantissant 200 heures d'exposition au brouillard salin.



EXTRA BRASS
Latón de alta calidad
High quality brass
Laiton de haute qualité

Latón de acuerdo Normas Europeas EN 12.164 / 5. El latón de fundición es una aleación con pocas impurezas y sin poros. El latón forjado (estampación) se obtiene por extrusión, con altos porcentajes de Cobre (60%) que le dan gran elasticidad. El bajo contenido de Estaño evita incidencias producidas por fatiga. Los elementos clave de nuestra grifería utilizan Latón CW617, aleación de gran resistencia y durabilidad.

Brass according to European standard EN 12.164/5. Casting brass is an alloy with few impurities and without pores. Brass forged (stamping) is obtained by extrusion, with high copper levels (60%) which give great elasticity. The low Tin content avoids incidences produced by fatigue. All the main taps parts use brass CW617, which has a great resistance and durability.

Laiton aux normes européennes EN 12.164 / 5. Le laiton utilisé pour la fonte est un alliage avec très peu d'impuretés. Le laiton forgé (estampé) s'obtient par extrusion, avec de hauts pourcentages de cuivre (60%), qui lui donnent une grande élasticité. La faible proportion d'étain évite les problèmes dérivés de l'usure. Les éléments sensibles et ceux en contact avec leau sont fabriqués avec du laiton CW617, alliage de grande résistance et durabilité.

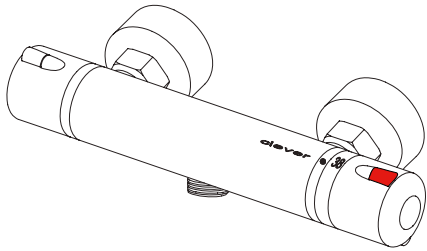
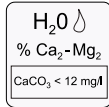

CUANDO INSTALAMOS LOS GRIFOS TERMOSTÁTICOS

- (1) Deben purgarse cuidadosamente las tuberías para eliminar arena y partículas sólidas del interior.
- (2) Es IMPRESCINDIBLE colocar los filtros en las entradas del agua fría y caliente.
- (3) Es IMPRESCINDIBLE que la toma del agua caliente esté situada a la izquierda y la del agua fría a la derecha.
- (4) PRESIÓN: Evitar que la presión del agua sea inferior a 1 bar o superior a 10 bar. La presión aconsejable es de 3 a 5 bar.
- (5) Usar calderas eléctricas de máxima capacidad posible, mínimo 200 litros, o calderas de gas con un caudal mínimo de 11 litros por minuto. Calderas de gas pequeñas (6 litros por minuto) no permitirán que el grifo funcione apropiadamente.
- (6) Recomendamos aislar térmicamente las tuberías del agua caliente.
- (7) Recomendamos instalar tuberías de diámetro mínimo 15mm

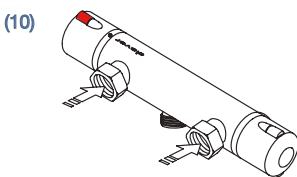
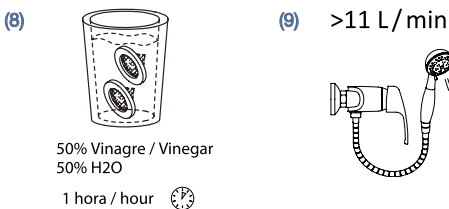
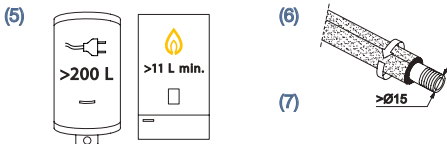
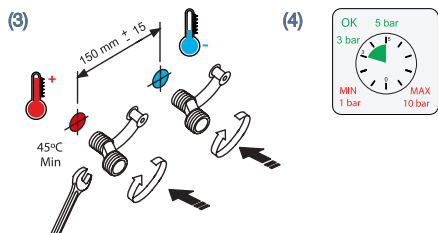
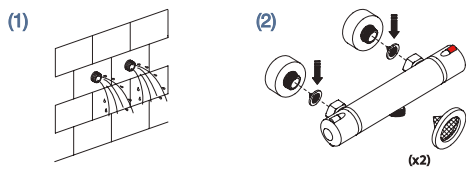

WHEN INSTALLING THERMOSTATIC TAPS

- (1) Water outlets have to be carefully cleaned to eliminate sand and dirty from inside them.
- (2) It's indispensable to place the filters in the cold and hot inlets.
- (3) It's INDISPENSABLE to place hot water inlet in left side and cold water inlet in the right side
- (4) PRESSURE: Avoid installing these thermostatic taps when the water pressure is less than 1 bar or more than 10 bar. The recommended pressure is between 3 to 5 bar.
- (5) Use electric heaters with as much capacity as possible, minimum 200 liters, or gas heaters with a minimum capacity of 11 liters per minute. Small gas heaters (6 liter per minute) will not allow the thermostatic tap to work properly.
- (6) We recommend thermal isolation for the hot water pipes.
- (7) We recommend installing pipes with a minimum diameter of 15 mm.

A L'INSTALLATION DE LA ROBINETTERIE THERMOSTATIQUE

- (1) Il faut d'abord purger soigneusement la canalisation afin d'éliminer le sable et toutes particules solides.
- (2) Il est indispensable de placer les filtres aux entrées d'eau chaude et froide.
- (3) Il est indispensable que la prise d'eau chaude soit située à gauche, et la prise d'eau froide à droite.
- (4) Pression: Il faut éviter une pression de l'eau inférieure à 1 bar ou supérieure à 10 bar. Il est conseillé une pression de 3 à 5 bar. Il est d'autre part recommandé que la différence de pression entre eau chaude et eau froide ne soit pas supérieure à 1 bar.
- (5) Utiliser un chauffage électrique avec la capacité la plus importante possible, minimum 200 litres, ou un chauffage au gaz avec un débit minimum de 11 litres par minute. Les petits chauffages au gaz (6 litres par minute) ne permettent pas un fonctionnement optimal de la robinetterie.
- (6) Nous recommandons une isolation thermique de la tuyauterie eau chaude.
- (7) Nous recommandons l'installation de tubes d'un diamètre minimum de 15 mm.

MANTENIMIENTO

- (8) Es necesario limpiar periódicamente los filtros, especialmente si el caudal disminuye injustificadamente, o si la temperatura no puede regularse bien.
- (9) Si el grifo termostático no trabaja correctamente, comprobar el caudal, debe ser superior a 11 litros por minuto.
- (10) Si toda la instalación no funciona correctamente, comprobar las válvulas anti retorno situadas en ambas entradas.

MAINTENANCE

- (8) Is necessary to clean regularly the filters, especially if the flow-rate decrease unjustifiably, or if temperature cannot be regulated properly.
- (9) If the thermostatic faucet doesn't work correctly, please check the flow-rate, there should be at least 11 liters per minute.
- (10) If the whole installation does not work appropriately, check the two check-valves placed in both inlets.

ENTRETIEN

- (8) Il est nécessaire de nettoyer périodiquement les filtres, spécialement si le débit diminue de manière injustifiée, ou si la température ne peut être correctement réglée.
- (9) Si la robinetterie thermostatique ne fonctionne pas correctement, il faut dans un premier temps vérifier le débit qui doit être supérieur à 11 litres par minute.
- (10) Si l'installation complète ne fonctionne pas, vérifier les valves anti retour situées sur chaque entrée.

Cambio cartucho

Change cartridge / Changement de cartouche

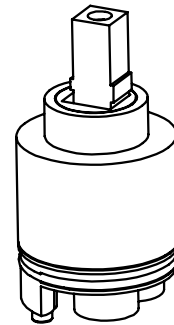
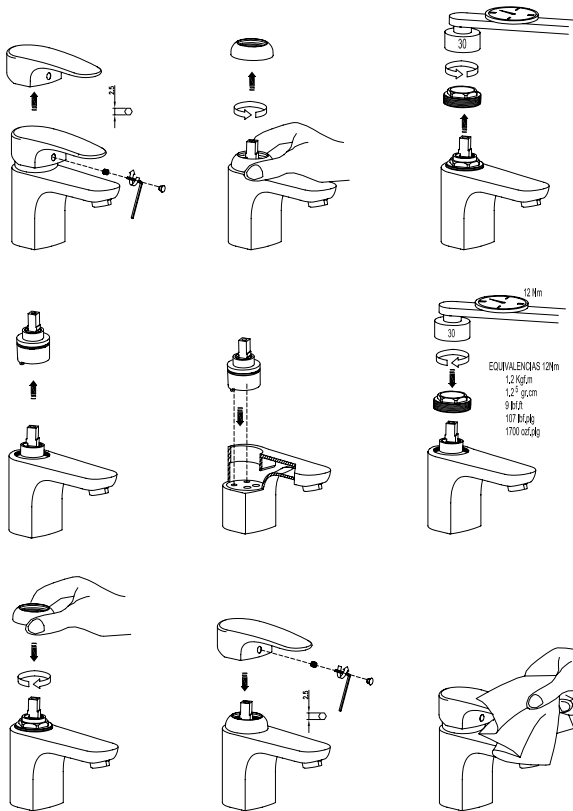

1. Sacar tornillo
2. Sacar maneta, desenroscar embellecedor
3. Sacar embellecedor, desenroscar tuerca
4. Sacar tuerca
5. Sacar cartucho, limpiar interior grifo
6. Cambiar cartucho, montar piezas.

1. Remove screw
2. Remove handle, unscrew the rosette
3. Remove the rosette and unscrew the nut
4. Remove nut
5. Cartridge Remove, clean inside faucet
6. Replace cartridge, assemble parts.

1. Retirer la vis
2. Retirer la manette, dévisser la couverture
3. Retirer la couverture, puis dévisser l'écrou
4. Retirer l'écrou
5. Retirer la cartouche, nettoyer l'intérieur du robinet
6. Changer la cartouche, monter les pièces.

Mantenimiento / Maintenance / Entretien

MANTENIMIENTO

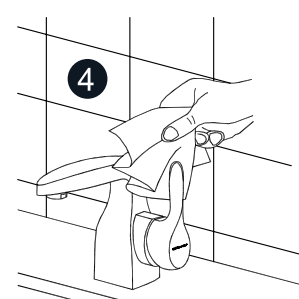
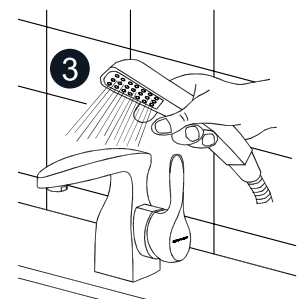
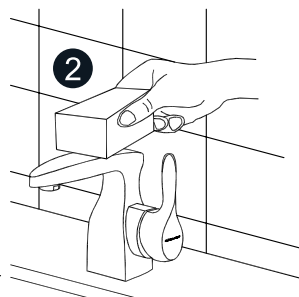
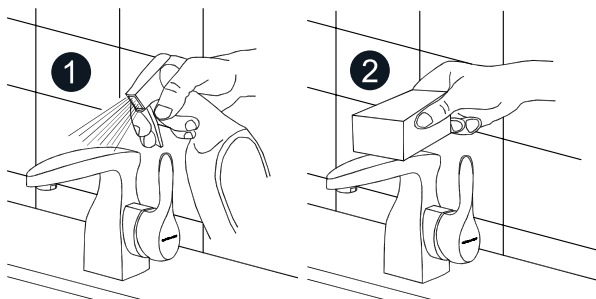

1. Limpiar con detergente líquido.
 2. Utilizar una esponja, gamuza o paño suave.
 3. Aclarar la grifería con agua.
 4. Secar después de cada uso.
 5. NO utilizar productos ácidos o abrasivos (HCl, HNO₃, H₂SO₄...).
- Totalmente desaconsejado productos que contengan HCl, ácido clorhídrico (sulfumán), destruye el cromo en pocos segundos.
6. NO utilizar ningún tipo de estropajo.
- Nuestra garantía no cubrirá los daños ocasionados por un uso inadecuado.**

MAINTENANCE

1. Clean with liquid detergent.
 2. Use a sponge, suede or soft flannel.
 3. Rinse the tap with water.
 4. Dry after every use.
 5. DO NOT use acids or abrasive products (HCl, HNO₃, H₂SO₄...).
- Products containing HCl, hydrochloric acid (muriatic acid) must be completely avoided, they destroy chrome in few seconds.
6. DO NOT use any type of scouring pad.
- Our guarantee does not cover damage caused by any inappropriate use.**

ENTRETIEN

1. Nettoyer avec un détergent liquide.
 2. Utiliser une éponge, une peau de chamois ou un chiffon doux.
 3. Rincer la robinetterie à l'eau.
 4. Sécher après chaque utilisation.
 5. NE pas utiliser de produits abrasifs (HCl, HNO₃, H₂SO₄...).
- Les produits contenant du chlorure d'hydrogène HCl ou de l'acide chlorhydrique détruisent le chrome en quelques secondes.
6. NE pas utiliser n'importe quel type d'éponge.
- Notre garantie ne couvrira pas les dommages occasionnés par un usage inadéquat.**

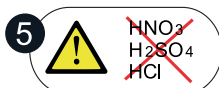



GRIFERIA CERTIFICADA

Approved taps · Robinetterie certifiée



GRIFERIA CERTIFICADA

Approved taps · Robinetterie certifiée



199	35162	1,29	222
199	35163	1,48	222
199	35164	0,89	222
2	35175	1,29	222
48	35176	1,48	222
0,48	35178	5,48	222
10,48	35179	0,89	222
10,48	35180	7,51	201
10,48	35181	9,15	201
13,47	35182	12,73	201
15,73	35184	5,35	201
20,08	35185	7,75	201
28,45	35187	7,75	201
35,28	35188	10,95	201
53,42	35189	14,75	201
92,51	35190	4,65	201
7,78	35191	5,40	201
7,85	35192	5,40	201
8,09	35193	4,40	201
11,18	35195	6,23	223
18,93	35196	0,99	200
9,59	35210	6,44	200
13,14	35211	8,71	200
17,39	35212	15,82	200
	35218	5,61	205
	35221	7,82	193

Índice de referencias y Condiciones de venta

Item directory and Sales conditions
Index des références et Conditions de vente

Índice de referencias

Item directory
Index des références
286

Condiciones de Venta

Sales conditions
Conditions de vente
292

Índice referencias

Item directory
Index des références

Ref.	€	Pág.
40010	12,00	236
40011	12,00	236
60100	125,00	50
60103	167,00	50
60106	125,00	51
60109	176,00	51
60110	156,00	51
60111	146,00	51
60112	126,00	51
60113	163,00	180
60114	18,00	240
60115	142,00	36
60118	192,00	36
60121	142,00	37
60124	230,00	37
60125	200,00	37
60126	195,00	37
60127	165,00	37
60128	171,00	177
60129	18,00	240
60130	16,00	240
60131	330,00	45-220
60132	300,00	45-220
60133	280,00	45-220
60134	250,00	45-220
60135	495,00	44-226
60139	16,00	241
60141	155,00	171
60142	260,00	168
60143	185,00	167
60144	205,00	167
60145	205,00	166
60146	205,00	166
60147	220,00	166
60148	220,00	166
60149	10,00	242
60150	173,00	174
60151	200,00	174
60152	163,00	173
60153	14,50	242
60154	370,00	43-220
60155	14,50	242
60156	73,00	113
60157	48,00	115
60158	42,00	116
60159	48,00	119
60160	34,00	119
60161	150,00	182
60162	215,00	57
60170	67,00	78
60173	77,00	78
60176	67,00	79
60179	116,00	79
60180	101,00	79
60181	95,00	79
60182	80,00	79
60183	84,00	187
60184	102,00	187
60185	67,00	82
60188	77,00	82
60191	67,00	83
60194	116,00	83
60195	101,00	83
60196	95,00	83
60197	80,00	83
60198	97,00	187
60301	36,00	138
60302	17,00	144
60303	56,00	139
60304	32,00	143

Ref.	€	Pág.
60305	77,00	139
60306	36,00	138
60307	17,00	142
60308	490,00	137
60310	18,00	240
60311	5,00	146
60312	16,00	241
60313	16,00	241
60314	30,00	244
60315	20,00	238
60316	20,00	238
60317	20,00	238
60318	20,00	238
60325	163,00	105-221
60326	148,00	105-221
60327	416,00	107-227
60328	386,00	108-229
60412	406,00	153-227
60413	376,00	153-228
60414	153,00	104-221
60415	138,00	104-221
60416	5,00	241
60417	6,00	241
60418	13,00	157
60558	11,00	237
60559	3,80	247
60563	94,00	113
60564	48,00	115
60565	42,00	117
60566	66,00	119
60567	36,00	123
90011	4,20	146
90025	5,75	242
90026	5,75	242
90027	5,75	242
90703	6,40	148
90704	8,30	148
90755	22,00	236
90758	18,00	145
90760	9,50	240
90761	9,50	240
90763	20,00	240
90770	10,00	240
90794	17,00	244
90796	12,00	145
92049	63,00	185
92075	43,00	198
92350	72,00	189
92351	78,00	189
92603	127,00	182
92801	43,00	210
92901	5,00	237
93510	117,00	62
93511	117,00	63
93512	257,00	63
93513	207,00	63
93528	73,00	264
93529	73,00	264
93530	135,00	264
93531	102,00	264
94458	8,00	241
94459	8,00	241
94474	70,00	64
94475	70,00	66
94476	122,00	65
94477	78,00	65
94489	26,00	65
94600	11,50	238
94694	59,00	92-215
94695	51,00	92

Ref.	€	Pág.
94696	51,00	92
94697	82,00	93
94698	67,00	93
95012	9,00	239
95040	2,50	246
95042	7,00	246
95043	3,75	245
95044	2,10	246
95045	2,10	246
95046	2,10	246
95051	11,75	246
95052	9,00	240
95110	9,00	239
95126	20,00	238
95132	20,00	238
95133	20,00	238
95135	20,00	238
95158	20,00	238
95163	20,00	238
95164	20,00	238
95165	20,00	238
95167	20,00	238
95168	20,00	238
95169	20,00	238
95172	9,00	239
95173	9,00	239
95174	9,00	239
95175	9,00	239
95178	20,00	238
95181	12,00	239
95182	12,00	239
95183	12,00	238
95184	12,00	238
95185	12,00	238
95186	12,00	238
95187	12,00	238
95190	12,00	239
95191	12,00	239
95192	12,00	239
95193	12,00	239
95194	12,00	239
95195	9,00	239
95196	9,00	239
95222	9,00	239
95223	9,00	239
95224	9,00	239
95225	9,00	239
95226	12,00	239
95227	12,00	239
95228	12,00	239
95229	12,00	239
95230	9,00	239
95231	9,00	239
95232	9,00	239
95233	9,00	239
95234	12,00	239
95235	12,00	239
95236	12,00	239
95237	12,00	239
95242	12,00	238
95243	12,00	238
95244	20,00	238
95245	20,00	238
95246	20,00	238
95247	20,00	238
95248	20,00	238
95249	20,00	238
95250	12,00	238
95251	12,00	238
95540	94,00	250

Ref.	€	Pág.
95663	21,00	252
95664	55,00	254
95665	52,00	254
95666	52,00	254
95667	520,00	252
95668	32,00	252
95669	32,00	252
95670	42,00	252
95671	70,00	254
95717	32,00	250
95749	37,00	252
95753	175,00	251
95754	65,00	251
95755	75,00	251
95756	40,00	252
95806	52,00	254
95821	180,00	250
95824	52,00	252
95828	90,00	253
95829	52,00	254
95832	90,00	253
95837	50,00	253
95838	90,00	253
95839	40,00	253
95840	42,00	253
96028	154,00	263
96066	114,00	94
96067	88,00	194
96084	57,00	102
96085	57,00	103
96086	84,00	103
96087	59,00	103
96088	48,00	198
96089	57,00	198
96090	143,00	264
96095	120,00	173
96097	26,00	103
96112	4,30	146
96114	16,00	139
96117	13,50	201
96118	185,00	247
96120	39,00	246
96122	14,10	148
96127	53,00	210
96128	41,00	210
96131	18,00	213
96132	32,00	213
96133	16,00	213
96134	31,00	214
96136	24,00	212
96137	15,00	236
96141	25,00	139
96152	64,00	210
96153	40,00	142
96154	440,00	67-231
96161	19,00	241
96164	19,00	241
96173	50,00	236
96174	42,00	236
96175	441,00	265
96176	467,00	265
96199	9,50	240
96200	5,75	242
96201	6,50	243
96202	4,75	242
96205	9,50	240
96208	8,00	241
96213	14,50	240
96216	14,50	240
96217	14,50	240

Ref.	€	Pág.
96223	12,00	238
96232	7,00	239
96233	7,00	239
96234	3,50	239
96238	5,40	245
96243	2,60	245
96253	18,00	240
96254	17,00	237
96255	17,00	237
96256	14,00	239
96264	20,75	146
96267	6,00	246
96268	9,00	239
96273	90,00	244
96292	42,00	246
96299	9,00	246
96340	51,00	88
96341	51,00	88
96342	82,00	89
96343	67,00	89
96344	72,00	188
96345	78,00	188
96346	88,00	194
96365	520,00	163
96413	7,25	146
96422	9,00	239
96436	1075,00	58-228
96437	84,00	137
96458	11,00	146
96462	30,00	199
96464	9,75	201
96468	107,00	62
96490	333,00	31-220
96541	59,00	92
96746	557,00	66-227
96747	483,00	67-231
96749	317,00	63
96754	30,00	199
96755	255,00	265
96767	30,00	199
96771	410,00	265
96776	243,00	263
96777	182,00	263
96778	283,00	263
96779	209,00	263
96786	21,00	145
96939	18,00	240
96942	7,75	146
97001	147,00	68
97002	147,00	69
97003	235,00	69
97004	215,00	69
97005	147,00	185
97006	224,00	68
97007	224,00	69
97012	407,00	70-220
97013	348,00	70-220
97018	1075,00	71-228
97020	678,00	70
97041	235,00	28
97042	235,00	28
97043	235,00	30
97044	381,00	30
97045	336,00	30
97046	225,00	177
97053	280,00	29
97054	250,00	29
97055	1000,00	32-229
97056	950,00	32-229
97057	1200,00	33-226

Ref.	€	Pág.
97058	1032,00	33-226
97059	250,00	29
97060	415,00	31
97061	137,00	56
97062	137,00	57
97064	205,00	57
97065	182,00	56
97069	192,00	184
97076	210,00	57
97086	162,00	181
97101	520,00	163
97104	45,00	175
97106	16,00	236
97107	15,50	236
97112	27,00	146
97113	18,00	146
97114	14,70	148
97142	15,00	145
97148	25,00	148
97276	245,00	136
97363	1,15	246
97364	30,00	244
97368	40,00	149
97369	12,95	240
97370	12,95	240
97371	12,95	240
97372	12,95	240
97379	18,00	240
97395	17,00	237
97396	3,40	148
97397	5,60	148
97399	6,40	246
97400	160,00	260
97401	243,00	260
97402	160,00	260
97403	245,00	261
97404	202,00	262
97405	167,00	261
97407	619,00	262
97410	190,00	260
97411	194,00	260
97417	1030,00	262
97419	1100,00	262
97474	18,00	240
97475	18,00	240
97670	8,75	148
97676	163,00	105-221
97688	2,00	245
97689	4,75	242
97692	148,00	105-221
97697	8,00	241
97698	8,00	241
97699	8,00	241
97740	27,00	212
97800	83,00	211
97801	110,00	211
97802	62,00	211
97803	57,00	211
97804	212,00	184
97805	84,00	195
97806	183,00	175
97809	15,50	212
97810	235,00	24
97811	285,00	24
97812	235,00	25
97813	381,00	25
97814	336,00	25
97815	285,00	176
97816	5,80	148
97817	18,00	240

Ref.	€	Pág.
97822	9,00	239
97823	9,00	239
97824	16,00	240
97825	3,40	245
97827	5,00	241
97828	5,00	241
97829	72,00	241
97846	351,00	25
97847	306,00	25
97853	351,00	30
97854	306,00	30
97862	215,00	261
97863	172,00	261
97870	185,00	57
97883	215,00	69
97884	195,00	69
97899	237,00	63
97900	187,00	63
97917	115,00	264
97918	82,00	264
97929	102,00	65
97930	58,00	65
97933	74,00	103
97934	49,00	103
97935	67,00	92
97955	377,00	261
97956	690,00	261
97973	57,00	198
97974	43,00	198
97975	92,00	201-215
97983	20,00	144
97984	24,00	142
97985	69,00	141
97986	80,00	141
97987	69,00	141
97988	86,00	140
97989	46,00	147
97990	53,00	147
97991	44,00	147
97992	57,00	147
97994	26,00	142
97996	15,00	139
97997	218,00	31
97998	160,00	31
97999	62,00	149
98000	64,00	142
98001	25,00	148
98004	34,00	149
98005	20,00	142
98006	10,50	201
98008	18,00	240
98009	285,00	26
98010	235,00	26
98011	235,00	27
98012	381,00	27
98013	336,00	27
98014	261,00	177
98022	35,00	148
98027	50,00	241
98102	127,00	54
98103	169,00	54
98104	127,00	55
98105	173,00	55
98106	143,00	55
98107	160,00	181
98141	51,00	90
98142	51,00	90
98143	82,00	91
98144	67,00	91
98145	69,00	189

Ref.	€	Pág.
98146	84,00	194
98149	163,00	106-221
98150	351,00	27
98151	306,00	27
98153	303,00	31-220
98158	387,00	70-220
98159	328,00	70-220
98160	297,00	63
98165	82,00	76
98166	80,00	77
98167	113,00	77
98168	91,00	77
98169	121,00	186
98175	84,00	74
98176	83,00	75
98177	145,00	75
98178	115,00	75
98179	153,00	186
98180	158,00	193
98185	122,00	60
98186	167,00	60
98187	122,00	61
98188	187,00	61
98189	157,00	61
98190	150,00	182
98197	142,00	38
98198	142,00	39
98199	213,00	39
98200	168,00	39
98201	171,00	178
98206	12,00	239
98208	5,50	146
98209	12,00	239
98210	12,00	239
98212	12,00	238
98213	12,00	238
98215	20,00	238
98216	20,00	238
98235	26,00	148
98236	26,00	148
98237	9,50	240
98238	9,50	240
98239	18,00	240
98240	12,00	238
98241	12,00	238
98242	12,00	238
98267	12,95	240
98280	98,00	77
98281	76,00	77
98282	130,00	75
98283	100,00	75
98320	19,00	235
98321	19,00	235
98322	32,00	235
98323	40,00	235
98324	155,00	234
98325	330,00	234
98326	39,00	234
98329	91,00	196
98330	51,00	100
98331	51,00	101
98332	82,00	101
98333	67,00	101
98334	72,00	190
98335	88,00	196
98340	72,00	101
98341	57,00	101
98342	7,75	145
98343	2,40	146
98344	78,00	190

Ref.	€	Pág.
98354	50,00	102
98413	210,00	38
98415	700,00	40-229
98416	144,00	40
98417	105,00	40
98423	176,00	75
98426	178,00	64
98429	146,00	65
98440	100,00	149
98441	100,00	149
98442	50,00	212
98444	185,00	263
98446	260,00	29
98447	406,00	30
98448	58,00	214
98449	26,00	101
98450	31,00	197
98451	27,00	213
98455	72,00	94
98456	112,00	94
98458	26,00	214
98459	31,00	197
98470	186,00	55
98478	178,00	106-221
98490	9,75	240
98491	14,50	240
98492	27,00	242
98493	31,00	242
98497	14,50	245
98500	88,00	195
98501	31,00	197
98517	185,00	247
98518	48,00	139
98527	309,00	155-230
98539	183,00	39
98540	138,00	39
98541	153,00	55
98542	123,00	55
98543	167,00	61
98544	137,00	61
98549	91,00	193
98552	122,00	193
98601	4,75	242
98610	71,00	86
98611	67,00	87
98612	116,00	87
98613	95,00	87
98614	99,00	188
98615	85,00	187
98630	12,95	240
98631	12,00	239
98632	12,00	239
98640	450,00	109-227
98645	101,00	87
98646	80,00	87
98647	38,00	246
98650	13,00	120
98651	29,00	120
98652	34,00	120
98653	37,00	120
98654	84,00	120
98655	24,00	116
98656	35,00	116
98657	33,00	116
98658	51,00	116
98659	124,00	116
98666	2,50	245
98667	2,60	245
98671	575,00	152-228
98672	48,00	139

ÍNDICE REFERENCIAS

Ref.	€	Pág.
98673	13,00	237
98674	14,00	237
98675	17,00	237
98678	166,00	49
98679	136,00	49
98680	135,00	48
98681	135,00	49
98682	186,00	49
98683	156,00	49
98684	163,00	180
98689	190,00	184
98690	107,00	52
98691	107,00	53
98692	153,00	53
98693	123,00	53
98694	160,00	181
98699	133,00	53
98700	103,00	53
98703	120,00	126
98706	136,00	126
98707	136,00	126
98708	136,00	126
98709	136,00	126
98710	136,00	126
98711	79,00	128-130
98714	95,00	128
98715	95,00	129
98716	95,00	128
98717	95,00	129
98718	95,00	129
98719	95,00	129
98720	95,00	128
98721	95,00	128
98723	95,00	129
98724	90,00	129
98725	90,00	129
98726	90,00	129
98729	120,00	130
98730	120,00	131
98731	120,00	130
98732	120,00	131
98733	120,00	131
98734	120,00	131
98735	120,00	130
98736	120,00	130
98738	120,00	131
98739	106,00	131
98740	106,00	131
98741	106,00	131
98742	109,00	132
98745	169,00	132
98746	169,00	132
98747	169,00	132
98748	169,00	132
98749	169,00	132
98750	219,00	132
98751	3,50	246
98752	3,50	246
98757	295,00	167
98758	20,00	238
98759	30,00	244
98760	200,00	175
98761	416,00	107-227
98762	406,00	153-227
98763	168,00	107-221
98764	280,00	167
98766	88,00	194
98767	72,00	188
98774	5,75	242
98775	9,00	242

Ref.	€	Pág.
98776	18,00	241
98781	15,00	240
98783	177,00	48
98784	147,00	52
98785	376,00	30
98786	2,35	243
98787	4,75	243
98788	5,90	243
98789	5,90	243
98791	6,10	243
98792	6,10	243
98793	4,50	243
98794	4,50	243
98795	4,50	243
98796	2,35	243
98797	2,35	243
98798	33,00	212
98799	35,00	212
98800	57,00	100
98803	76,00	190
98804	82,00	190
98817	72,00	93
98818	57,00	93
98822	196,00	105-221
98823	211,00	106-221
98824	32,00	116
98825	26,00	120
98826	46,00	121
98827	42,00	121
98850	482,00	154-231
98866	13,30	240
98867	13,30	240
98868	13,30	240
98869	13,30	240
98870	12,00	240
98871	16,00	240
98872	16,50	240
98880	22,00	148
98881	21,00	156
98884	17,00	144
98885	16,50	156
98886	62,00	157
98888	25,00	144
98892	134,00	138
98895	65,00	123
98896	43,00	123
98897	48,00	123
98899	98,00	136
98902	16,00	240
98903	16,00	240
98910	82,00	74
98913	148,00	186
98914	80,00	76
98917	119,00	186
98918	69,00	86
98921	89,00	187
98922	97,00	188
98923	35,00	266
98924	30,00	266
98925	24,70	266
98926	6,75	242
98927	6,75	242
98928	181,00	105-221
98929	196,00	106-221
98986	2,60	245
98992	31,00	197
98995	376,00	153-228
98996	120,00	247
98997	13,75	146
98998	12,00	245

Ref.	€	Pág.
99108	150,00	181
99127	14,00	237
99128	9,50	148
99129	13,00	145
99130	8,00	237
99136	215,00	157
99142	279,00	155-231
99145	80,00	74
99149	78,00	76
99153	67,00	86
99161	55,00	100
99172	39,00	247
99173	15,00	201
99174	30,00	244
99185	92,00	74
99186	94,00	74
99187	96,00	74
99195	86,00	76
99196	89,00	76
99197	91,00	76
99205	77,00	86
99206	79,00	86
99207	81,00	86
99214	59,00	100-216
99215	82,00	200-216
99216	96,00	201-216
99217	14,00	239
99221	65,00	192
99222	67,00	192
99223	69,00	192
99224	9,00	239
99225	9,00	239
99226	11,75	240
99227	14,80	240
99228	16,00	240
99229	5,75	242
99230	5,75	242
99231	5,75	242
99232	5,75	242
99233	5,75	242
99242	53,00	98
99245	63,00	98
99248	55,00	98
99251	65,00	98
99265	76,00	190
99317	53,00	96
99320	63,00	96
99323	55,00	96
99326	65,00	96
99340	76,00	189
99386	84,00	192
99388	88,00	192
99389	93,00	193
99392	33,00	80-214
99393	26,00	80-213
99398	12,00	266
99410	258,00	34
99413	195,00	34
99416	195,00	35
99419	335,00	35
99420	305,00	35
99421	248,00	35
99422	218,00	35
99423	203,00	177
99424	20,00	238
99425	20,00	238
99426	20,00	238
99427	20,00	238
99428	265,00	22
99431	265,00	22

Ref.	€	Pág.
99434	405,00	23
99435	375,00	23
99436	360,00	23
99437	330,00	23
99438	335,00	176
99439	885,00	23
99440	177,00	170
99441	192,00	170
99442	254,00	170
99443	223,00	168
99444	306,00	162
99445	343,00	162
99446	20,00	238
99447	20,00	238
99450	92,00	156
99451	19,00	114
99452	32,00	114
99453	33,00	114
99454	36,00	114
99455	33,00	114
99456	63,00	115
99457	90,00	115
99458	160,00	115
99459	22,00	118
99460	33,00	118
99461	32,00	118
99462	45,00	118
99463	42,00	118
99464	31,00	118
99465	34,00	119
99466	53,00	119
99467	83,00	119
99468	124,00	119
99469	105,00	121
99470	18,00	112
99471	46,00	112
99472	62,00	112
99473	44,00	112
99474	41,00	112
99475	52,00	112
99476	38,00	113
99477	78,00	113
99478	98,00	113
99479	160,00	113
99480	99,00	121
99481	22,00	122
99482	27,00	122
99483	32,00	122
99484	37,00	122
99540	12,00	240
99541	14,80	240
99542	16,00	240
99543	16,00	240
99600	75,00	136
99601	217,00	136
99602	134,00	136
99603	68,00	136
99604	24,00	138
99606	38,00	138
99607	34,00	139
99608	50,00	138
99609	15,00	145
99610	30,00	143
99611	17,00	145
99612	23,00	145
99613	26,00	143
99614	15,00	145
99615	16,00	144
99616	83,00	149
99617	83,00	149

Ref.	€	Pág.
99618	40,00	147
99619	42,00	147
99620	66,00	147
99621	46,00	147
99622	53,00	147
99623	216,00	141
99624	62,00	140
99625	67,00	140
99626	85,00	140
99627	80,00	140
99628	86,00	140
99646	360,00	80-230
99652	55,00	241
99656	16,00	240
99657	30,00	244
99658	30,00	244
99659	20,00	238
99660	27,00	242
99661	22,00	242
99664	18,00	240
99665	16,25	240
99667	16,25	240
99668	16,25	240
99669	16,25	240
99670	16,25	240
99671	16,25	240
99672	16,25	240
99673	16,25	240
99674	16,00	240
99684	183,00	175
99685	160,00	137
99686	152,00	137
99687	137,00	137
99688	347,00	136
99689	306,00	136
99690	127,00	136
99691	153,00	136
99692	140,00	136
99693	161,00	136
99708	339,00	176
99715	207,00	177
99718	209,00	126
99719	130,00	128
99720	151,00	130
99727	360,00	84-230
99731	575,00	42-226
99732	500,00	43-230
99733	245,00	168
99735	205,00	168
99736	55,00	241
99737	15,00	242
99799	72,00	89
99800	57,00	89
99801	72,00	91
99802	57,00	91
99817	12,00	240
99820	51,00	98
99823	61,00	98
99826	51,00	99
99829	82,00	99
99830	72,00	99
99831	67,00	99
99832	57,00	99
99833	72,00	190
99834	88,00	195
99835	51,00	96
99838	61,00	96
99841	51,00	97
99844	82,00	97
99845	72,00	97

Ref.	€	Pág.
99846	67,00	97
99847	57,00	97
99848	72,00	189
99849	88,00	195
99850	140,00	171
99851	140,00	171
99852	20,00	238
99853	6,75	242
99862	2,50	245
99928	131,00	83
99931	131,00	79
99944	84,00	192
99945	88,00	192
C75236	3345,00	207
C75237	11,80	207
C75238	78,20	207
C75239	79,00	207

Condiciones de venta

Sales conditions
Conditions de vente

Condiciones generales de venta

1. Generalidades

Las ventas a efectuar por el GRUPO STH, compuesto por Standard Hidráulica, Hidrostandard del Mediterráneo y Comap Ibérica, se regirán por las presentes Condiciones Generales de Venta, excepto todo aquello que esté expresamente pactado de forma distinta en la confirmación de pedido u oferta

2. Precios

Los precios de nuestra tarifa se expresan en € (impuestos no incluidos) y en condiciones Ex Works Montcada i Reixac. El importe mínimo de pedido para PORTES PAGADOS será a determinar en función de las condiciones particulares de cada país y cliente. Dentro del territorio de España y Portugal, los pedidos cuyo importe neto sea superior a 200 € viajarán a PORTES PAGADOS, por debajo de este importe podrán viajar a portes pagados cargando un importe fijo en factura de 6 €, o si lo prefieren, a portes debidos. Quedan excluidas las Islas Canarias, Ceuta, Melilla, Azores y Madeira donde el pedido mínimo para PORTES PAGADOS será de 900 € y por debajo de éste se cargará un importe en factura según tarifa de agencia.

GRUPO STH se reserva el derecho de modificar los precios de la tarifa en vigor en cualquier momento sin necesidad de preaviso. Los precios aplicables serán los vigentes en el momento en que se realice el pedido. En caso de envío de muestras, estas serán a cargo del cliente.

3. Plazo de entrega y descarga de la mercancía

Los pedidos que se reciban sin indicación de fecha de entrega, se servirán en el plazo más breve de tiempo. Las fechas de envío que aparecen en la confirmación del pedido son orientativas. Las entregas anticipadas y los envíos parciales estarán autorizados si no existe un acuerdo por escrito que lo prohíba. La incapacidad de efectuar o servir un pedido por motivos de huelga, fracaso de la negociación, cierre de negocio y consecuencias derivadas de los mismos serán consideradas como de fuerza mayor y eximen a GRUPO STH de su obligación de servir la mercancía y, el cliente no podrá reclamar en modo alguno daños y perjuicios. En el caso de aplazamiento de pago de las facturas pendientes así como de su impago, y/o por exceder el cliente el límite de crédito que GRUPO STH tenga asegurado, los pedidos pendientes de servir quedarán bloqueados hasta la resolución de la incidencia en cuestión.

4. Facturación

El GRUPO STH se reserva el derecho de enviar y facturar los pedidos del cliente por cualquiera de las empresas del grupo, dependiendo de la situación crediticia del cliente. Los datos de la empresa proveedora se detallarán en el albarán de venta, no aceptando ninguna modificación tras el envío de la misma. GRUPO STH trabaja con facturación electrónica.

5. Condiciones de Pago

La financiación máxima nunca excederá de los parámetros contemplados en la Ley 15/2010 por la que se establecen medidas de lucha contra la morosidad en las operaciones comerciales. La falta de pago a un vencimiento de cualquier factura conllevará la inmediata suspensión del suministro de materiales. En caso que GRUPO STH conceda al Cliente un aplazamiento en el pago de una factura más allá de la fecha de vencimiento inicialmente pactada, se aplicará sobre el importe de dicha factura una penalización de un 3% mensual. En caso de impago, dicha penalización será del 5% mensual, con un mínimo de 15€, al que se le añadirá un 3% mensual a partir del 2º mes de demora. Independientemente del concepto que el cliente de a un pago, los pagos que se efectúen se imputarán en primer lugar a las penalizaciones por aplazamiento y/o impago, y a continuación al principal de las deudas que tengan un vencimiento más antiguo. Todas las operaciones comerciales están aseguradas por una entidad de seguro de crédito.

6. Devolución de mercancía

Todas las solicitudes de devolución deberán ser analizadas y aceptadas por el GRUPO STH, debiendo informar el cliente de los motivos de las mismas y justificando la fecha de compra con la factura. Las devoluciones ocasionadas por defectos de identidad y/o cantidad deberán ser gestionadas durante los 7 días posteriores a la entrega de material.

Para el resto de devoluciones se analizarán en base a los criterios marcados por el grupo STH. No se aceptará ningún material que esté descatalogado o fuera de garantía. Se aplicará un demérito a las devoluciones aceptadas, que podrá ir del 15% al 50% según el año de compra. Los portes serán a cargo del cliente.

7. Reclamaciones, garantía y compensación

De conformidad con lo establecido en la legislación vigente, la reclamación por daño o avería de las mercancías transportadas así y como diferencias de cantidad recibidas, deberá hacerse en las 24 horas siguientes a la recepción conforme de las mismas, salvo que el daño fuera evidente en el momento de la recepción de las mercancías.

El GRUPO STH garantiza la grifería de este catálogo durante 5 años ante eventuales defectos de fabricación. La fecha de adquisición debe justificarse adecuadamente mediante la correspondiente factura de compra. Para que la garantía sea válida, es necesaria la aceptación del defecto por parte del departamento técnico.

Quedan excluidos de la garantía los daños producidos por instalación, mantenimiento y limpieza no realizada de acuerdo con las instrucciones de montaje, así como su uso inadecuado y desgaste natural.

La garantía cubre la reposición del material sin cargo, limitando nuestra responsabilidad a la sustitución o reparación de las piezas defectuosas reconocidas por GRUPO STH, sin indemnización alguna. En caso de que el producto ya no se fabrique, se suministrará un producto similar de igual calidad.

Los cartuchos termostáticos, temporizados y mecanismos electrónicos tienen una garantía de 2 años.

Los accesorios (flexos, teléfonos de ducha, rociadores, soportes, barras de ducha, etc.) tienen una garantía de 2 años.

Nos reservamos el derecho de modificar el diseño de nuestros productos sin previo aviso.

8. Reserva de dominio

El GRUPO STH será propietario de los productos suministrados al cliente hasta el cobro completo de la factura correspondiente.

9. Responsabilidad Civil derivada del producto

GRUPO STH sólo será responsable de los daños derivados de defectos de calidad internos de los productos y que ya fueran existentes en el momento de su expedición al cliente. GRUPO STH nunca será responsable de los daños derivados de defectos de calidad aparentes de los productos y que pudieron ser detectados por el cliente antes de su reventa o montaje en cualquier obra y/o instalación, así como de los daños derivados de una mala instalación y/o manipulación de dichos productos, incumplimiento de las condiciones de montaje, puesta en funcionamiento y utilización (como por ejemplo en las instrucciones de uso) o de las condiciones administrativas establecidas.

Las limitaciones de responsabilidad serán aplicadas completamente a los sucesivos compradores, con la obligación de ser adoptadas por todos los futuros compradores.

10. Daños a destinatarios

En caso que el cliente tenga conocimiento, por cualquier motivo, de la producción de daños a un destinatario que pudiesen ser derivados de los productos (especialmente en caso de reclamación formal o legal de dicho destinatario al cliente), deberá notificarlo de forma urgente y por escrito a GRUPO STH y facilitarle la comprobación y valoración de dichos daños y sus causas para poder establecer de quién pudiesen provenir las responsabilidades y no dejar a GRUPO STH en absoluta indefensión.

GRUPO STH en ningún caso responderá por ninguna reclamación de daños provenientes de los productos (ya sean acciones directas o de repetición) si no ha tenido la ocasión de poder valorar y comprobar la realidad de los daños y sus posibles causas.

11. Limitación de la responsabilidad civil derivada de producto

Se establece como límite máximo de la responsabilidad civil que asumirá GRUPO STH derivada de daños causados por los productos, un importe de 2.000 €.

12. Jurisdicción y Derecho aplicable

Respecto a todos los litigios que surgieran en el marco de la relación contractual entre GRUPO STH y el cliente serán competentes los Juzgados y Tribunales de Barcelona. Asimismo, se acuerda como Derecho aplicable el Derecho Español.

13. Validez

Estas condiciones de venta anulan las anteriores y estarán vigentes hasta cualquier cambio publicado en www.standardhidraulica.com

Sales conditions

1. General

In these conditions, reference to STH GROUP (Standard Hidraulica, S.A.U., Hidrostandard del Mediterráneo, S.A.U. and Comap Ibérica). All quotations are made and all orders are accepted subject to these conditions. All other terms, conditions or warranties whatsoever are excluded from the contract or any variation thereof unless expressly accepted by the company in writing. In the event of a conflict between these conditions and the specific terms and conditions of quotation then the latter shall prevail.

2. Prices

All prices in the catalogue are in Euros, and these are exclusive of VAT which will, if applicable, be added to the invoice at the current rate. The price payable for the goods shall, unless otherwise agreed, be the company's list price current at the date of dispatch. Our company reserves the right to modify the prices in force at any time without any need for forewarning. Costs of delivery to any destination different than Spain will be agreed with STH Group. Samples will be charged to the customer with special conditions.

3. Delivery of the goods

Orders with no specific delivery time, will be dispatched as soon as possible. The delivery dates appearing on the order confirmation are estimates only, advanced deliveries and partial dispatches will be authorized if there is no written agreement that forbids them. Any incapacity to effect or supply an order for reasons such as: strike, breakdown of the negotiations, close down the business and all their consequences will be considered a force majeure and release STH Group from his obligation to supply the goods and the customer may not make any claim for damages. In the case of postponing the payment of the outstanding invoices, as well as unsettling them and exceeding the limit of the assured credit, the outstanding orders will be kept in our warehouse until the incident is solved.

4. Invoices

All the commercial deals are insured by an Insurance Company. STH Group reserves the right to invoice the customer by any company from the Group depending the Insurance amount the client has. The company's details will be informed in the delivery note, without any possible change once we send it. STH Group works with electronic invoicing.

5. Payment conditions

The payment conditions in the invoice have to be considered as unconditional: every change has to be agreed in advanced. The Company reserves the right to charge interest at a rate up to 3% per month, and the non-payment will be charged up to 5%, with a minimum amount of 15 €, and 3% will be added each month from the second month of the delay. If the payment is not insured, STH Group will agree with the client the payment terms.

6. Transport

The shipments will be held at STH GROUP facilities on the customer's risk and account. In the case of carriage paid transport, the Company may choose the forwarder. Any damages or losses must be determined by the Customer, detailed always in the transport delivery note. According to the current rules, all discrepancies at delivery must be specified within the first 24 hours, after giving the ok to the transport delivery note.

7. Goods return and dispatch

STH Group is not obligated to accept any partial or total return of any goods ordered previously by the customer. If the customer wishes to return goods for any specific reason and the Company accepts it in writing, the following rules must be observed: The claim must be sent in writing, by telephone, fax or email to STH GROUP, always giving the invoice referred when it was purchased. All returns will be sent once the claim has been accepted. The claim will be together with the delivery note, specifying if it is a wrong or faulty material, the invoice no. and purchase date of the shipment. All carriage paid material returned will be carried by the transport agency chosen by STH GROUP. The goods returned that do not fulfil these requirements will be sent back to the origin. The goods which have been returned for different reasons than the ones mentioned before, will be charged with a demerit, and the transport costs will be paid by the customer. The products which are discontinued and are out of guarantee will not be accepted.

8. Reserve of domain

STH Group will be the owner of the goods until the invoice is settled in full.

9. Claims, warranty and compensation

Any fault or anomaly, including a shortfall in the assured quality of the product, must be reported in writing within the following 24hours after its reception unless the problem cannot be seen easily. The guarantee that will be applied to the products referred in this catalogue will be for 5 years. Except for:
- Thermostatic cartridges, delay actions and electronic mechanisms will have 2 years guarantee.
- Accessories will also have 2 years guarantee (hose bibs, hand showers, rain showers, holders, sliding bars...)
To all effects, the guarantee will start from the invoice date on. It will be excluded from the guarantee all the products damaged from their installation, maintenance and cleaning which is not done according to the rules and its unappropriated use. The guarantee covers to replace or repair the goods, if these are discontinued will be substitute them for similar ones.

10. Liability

Outside the application of the product liability's laws, the Company will only be responsible for damage, if according to legal resolutions, serious blame is proved. The Company will not reply and there will be no claim for damages in the case of non-fulfilment of assembly conditions, come into operation and use (such as in the use instructions) or in the established administrative conditions. The limitations of responsibility will be applied in full on successive purchasers, and must be adopted by all future ones. Once the customer knows the damage caused by one faulty product, he has to inform immediately STH Group in a writing way and add all the necessary information to show causes and possible responsibilities for STH Group defense. The maximum limit of liability which will be paid by STH Group derived from a faulty product it will be 2.000€

11. Jurisdiction and applicable Law

With respect to all lawsuits that might arise within the framework between the Company and the customer contractual relationship, the Courts and Tribunals of Barcelona will hold all competence. Likewise, it is agreed that the applicable Law will be Spanish Law.

12. Validity.

These Conditions cancel the previous ones and they will be valid till any modification is published in our website www.standardhidraulica.com

Condiciones générales de vente

1. Généralités

Les ventes effectuées par le Groupe STH, composé des sociétés Standard Hidráulica, Hidrostandard del Mediterráneo et Comap Ibérica, seront assujetties aux présentes Conditions générales de vente, à l'exception des cas particuliers accordés expressément sur l'offre ou la confirmation de commande.

2. Prix

Les prix figurant dans notre tarif sont exprimés en €, hors taxes, et en conditions Ex Works Montcada i Reixac. Le montant minimum des commandes pour obtention du Franco de Port sera déterminé en fonction des conditions particulières de chaque pays et client. Le Groupe STH se réserve le droit de modifier les prix du tarif en vigueur, sans délai d'avis préalable. Les prix appliqués seront ceux de la date de réception de la commande. Les frais d'envoi d'échantillons seront à la charge du client.

3. Délais de livraison

Les commandes reçues sans indication de date de livraison seront livrées dans le meilleur délai possible. Les délais de livraison qui figurent sur la confirmation de commande le sont à titre indicatif. Les livraisons anticipées et/ou partielles sont considérées autorisées, sauf accord contraire par écrit. Le non-respect des délais pour des raisons de grève, d'échec des négociations, de clôture d'entreprise et les raisons dérivées de ces situations seront considérées de force majeure ne pourront constituer un motif de droit ou de pénalité, ni de dommages et intérêts au bénéfice de l'acheteur. En cas de retard ou de non-paiement, ou si les sommes dues dépassent le montant assuré par notre compagnie d'assurance, les commandes en attente de livraison seront bloquées jusqu'à résolution de la situation.

4. Facturation

Le Groupe STH se réserve le droit d'envoyer et de facturer les commandes du client par le biais des différentes sociétés du Groupe selon la situation de crédit du client. Les données du fournisseur seront indiquées sur le bon de livraison. Aucune modification ne sera admise après expédition. Le groupe STH utilise un système de communication électronique pour l'envoi des factures.

5. Conditions de paiement

Le financement ne pourra en aucun cas excéder les paramètres définis dans la Loi 15/2010 qui stipule les mesures contre les retards de paiement dans les opérations commerciales. Le non-paiement d'une facture à son échéance entraînera la suspension immédiate de toute autre livraison. Lorsque le Groupe STH accordera au client un délai dans le paiement d'une facture au-delà de la date d'échéance initialement accordée, il sera appliqué une pénalisation de 3% mensuels sur le montant de la facture. En cas de non-paiement, cette pénalisation sera de 5% mensuels, avec un seuil de 15 €, auxquels s'ajouteront 3% mensuels à partir du 2ème mois de retard. Tout paiement reçu sera imputé en premier lieu aux éventuelles pénalisations pour retards ou impayés, puis au montant principal des dettes les plus anciennes, indépendamment du concept indiqué par le client. Toutes les transactions commerciales sont assurées par une compagnie d'assurance-crédit.

6. Retours de marchandise

Toutes les demandes de retour devront être dûment documentées par le client et présenter la facture relative à l'achat, puis analysées et acceptées par le Groupe STH. Les retours de marchandise pour défaut d'identité et/ou de quantité devront être effectués dans les 7 jours suivant la réception du matériel. Toute autre demande de retour devra être analysée en fonction des critères définis par le groupe STH. Aucun retour de matériel déclassé ou hors garantie ne sera accepté. Les retours acceptés par le Groupe STH seront crédités en leur appliquant une baisse de valeur de entre 15% et 50% en fonction de l'année d'achat du matériel. Frais de port à la charge du client.

7. Réclamations, garantie et compensation

Conformément aux dispositions légales, en cas de dommage ou d'avarie de la marchandise transportée, ainsi que les incidences sur les quantités, le client devra procéder aux réserves d'usage auprès du transporteur, à la réception du matériel ou dans les 24 h. suivantes.

Le groupe STH garantit la robinetterie de ce catalogue pendant 5 ans contre d'éventuels défauts de fabrication. La date d'acquisition devra être dûment justifiée par présentation de la facture d'achat correspondante. La garantie de sera appliquée que dans les cas où le défaut est confirmé par le Département Technique.

Notre garantie ne s'étend pas aux défauts résultant d'un mauvais emploi, d'un montage non conforme aux prescriptions, de négligence dans l'entretien ou dans l'utilisation du produit.

Sont également exclus de la garantie tout dommage lié à la qualité de l'eau.

La garantie couvre l'envoi des produits sans frais, notre responsabilité restant limitée au remplacement ou à la réparation des pièces reconnues défectueuses par le groupe STH, sans aucune indemnisation. Dans le cas où le produit ne soit plus fabriqué, nous nous engageons à livrer un produit similaire de même qualité.

Les cartouches thermostatiques, temporisées et mécanismes électroniques ont une garantie de 2 ans.

Les accessoires (flexibles, douchettes, pommes de douches, supports, barres de douche, etc.) ont une garantie de 2 ans.

Nous nous réservons le droit de modifier le design de nos produits sans avis préalable.

8. Réserve de propriété

Le Groupe STH sera propriétaire des produits livrés au client jusqu'au complet encaissement de la facture correspondante.

9. Responsabilité civile dérivée du produit

Le groupe STH ne peut être considéré responsable que des défauts de qualité internes du produit déjà existants lors de l'expédition au client. Le groupe STH ne peut être tenu pour responsable des dommages dérivés d'un défaut de qualité apparent et qui aurait dû être constaté par le client avant sa revente, son installation ou montage, ainsi que de ceux dérivés d'une erreur d'installation et/ou d'une manipulation de ces produits non conforme aux conditions de montage, de mise en fonctionnement (indiqués dans les instructions de montage) ou des conditions administratives établies.

Les limites de la responsabilité seront appliquées aux acheteurs successifs, avec l'obligation d'être adoptées par tous les futurs acheteurs.

10. Dommages aux destinataires

Dans le cas où le client prenne connaissance de la production de dommages à un destinataire qui pourraient être dérivés des produits (et tout particulièrement en cas de réclamation formelle ou légale de la part du destinataire au client), ce dernier devra le signaler de toute urgence et par écrit au Groupe STH, et lui fournir la preuve desdits dommages ainsi que leur cause et leur estimation, afin de pouvoir établir au mieux les responsabilités et ne pas laisser le Groupe STH sans défense.

Le Groupe STH décline toute responsabilité en cas de réclamation pour dommages relatifs aux produits (provenant d'actions directes ou répétées), si la possibilité de pouvoir évaluer et vérifier la réalité des dommages et leur cause ne lui a pas été donnée.

11. Limitation de la responsabilité civile dérivée du produit

Le montant maximum de l'indemnité qui pourra être assumé par le Groupe STH en matière de responsabilité civile dérivée des dommages causés par ses produits est fixé à 2000 euros.

12. Jurisdiction

En cas de contentieux dans le cadre de la relation contractuelle entre le Groupe STH et le client, le Tribunal de Barcelone sera seul compétent. La loi espagnole sera la seule applicable.

13. Validité

Ces conditions de vente remplacent toutes les précédentes et resteront en vigueur jusqu'à une nouvelle publication sur www.standardhidraulica.com

NOTAS



NOTAS



NOTAS



Every design, an emotion



@CleverGrferia



GrferiaClever



GrferiaClever

www.grferiaclever.com

STH Standard Hidráulica

A COMAP GROUP COMPANY

Avenida La Ferreria, 73-75 · Pol. Ind. La Ferreria
08110 - Montcada i Reixac · Barcelona - Spain
Tel. +34 93 564 10 94 · info@grferiaclever.com

COMAP