

clever

R O B I N E T T E R I E



Bath & Kitchen

— COLLECTION 2019 —

clever

R O B I N E T T E R I E

La marque **Clever** est née en 1998 au sein de **Standard Hidráulica S.A.U.**, une entreprise fondée à Barcelone en 1975 et reconnue comme l'un des principaux fabricants de **robinetterie** pour **la cuisine, la salle de bain et les collectivités** en Espagne. La **qualité**, le **service**, l'**innovation** et l'**excellence de nos designs**, associés à l'intégration constante des **nouvelles technologies** et le **suivi attentif de notre clientèle** sont les fondements de notre philosophie d'entreprise.

Clever taps was launched in 1998 by Standard Hidraulica, company founded in 1975, well known as one of the most important taps, mixers and showers manufacturers in Spain. Our company philosophy is based on quality, service, innovation, exquisite design and technology investigation.



Projects

Projects

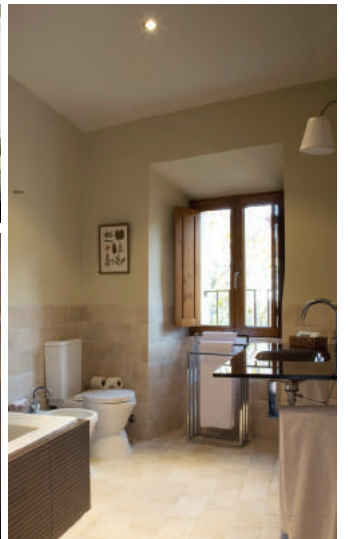
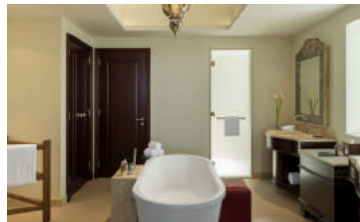
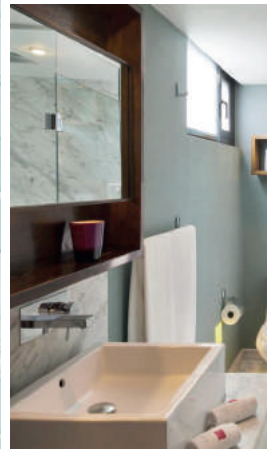
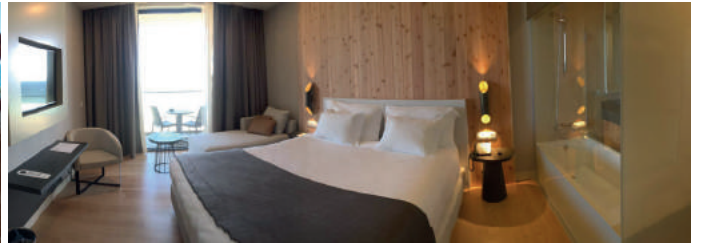

Découvrez la APP CLEVER

Discover the CLEVER APP



Réalité Augmentée

Bain et Cuisine

Augmented reality
Bath & Kitchen

Plus grande
facilité
d'utilisation

User friendly

Videos
incorporés

Integrated videos

Catalogue
des produits

Product catalogue

SCANNEZ VOTRE ESPACE DIRECTEMENT **avec votre tablette ou votre smartphone**
ET SÉLECCIONNEZ LA ROBINETTERIE QUI S'ADAPTE LE MIEUX **À VOTRE STYLE**

*Scan a space with your tablet or smartphone and add the tap
that better suits your design*

DÉCOUVREZ
LE FONCTIONNEMENT DE
la APP CLEVER
sur notre canal  **YouTube**

Discover the clever app in our Youtube channel



Download Clever App Free



Que signifie chaque symbole?

What's the meaning of each icon?

Design et qualité Design & Quality



PATENTED

Design exclusif et breveté
Exclusive and patented design



TOP WARRANTY

Garantie qualité 5 ans
5 years warranty

Sécurité Security



SAFETY BLOCK

Double système de sécurité pour thermostatique
Double security system for thermostatic



TERMOLIMIT

Limitation de la température
Temperature limit

Matériaux Materials



EXTRA BRASS

Laiton de haute qualité
High quality brass



EXTRA CHROME

Chromage de haute qualité
High quality chrome



MATT

Finition Mat
Mat finish



STAINLESS STEEL

Robinetterie en acier inox
Stainless steel taps



EUROCOLGADOR

Emballage avec orifice pour stockage sur broche
Retail packaging

Environnement Environment



AIR ADVANCED

Mélange air et eau
Air and water mixture



ECONATURE

Cartouche C2/ec2 avec 2 positions
C2/ec2 cartridge with 2 positions



PURE H₂O

Robinet eau pure osmosis
Filter sink mixer



WATER REDUCE

Système de réduction de débit
Flow reduction system

Technologie Technology



CERAMIC CONTROL

Disques céramiques
Ceramic disc



COLD OPEN

Ouverture en eau froide
Cold opening



COLD TOUCH

Robinetterie anti-brûlures
Anti-scald



EASYFIX

Facilité d'installation des éviers
Easy sink taps installation



MAGNET

Système magnétique de fixation
Magnetic system of subjection



ORIENTABLE

Aérateur orientable
Easy sink taps installation



WATERFALL

Effet cascade
Waterfall effect



SUPERFIX

Anti-mouvements éviers
Stop movement of sink mixer



ANTI-CAL

Dispositif anticalcaire
Anti lime



ULTRA SLIM

Pomme de douche
Ultra slim fixed heads



JET MASSAGE

Robinetterie à jets hydromassants
Mixer with hydromassage jets

Cartouche Cartridge



STANDARD

Modèle standard
Standard model



ECONATURE

Économie d'eau. Cartouche avec 2 positions.
Water saving. Cartridge with 2 positions



ECONATURE + COLDOPEN

Économie d'eau et d'énergie
Water and energy saving

Index

Black&White	1_06
Aude	1_10
Selene	1_12
Bimini	1_14
Saona Slim	1_16
Paula	1_18
Agora <i>elegance</i>	1_20
Agora xtreme	1_22
Artic xtreme	1_24
Artic <i>urban</i>	1_26
Caiman <i>elegance</i>	1_28
Caiman xtreme	1_30
Start <i>elegance</i>	1_32
Start xtreme	1_36
S12 xtreme	1_40
With2 <i>antigona</i>	1_42
With2 morea	1_46
Thermostatiques <i>Thermostatics</i>	1_50
Combis	1_54
Douchettes, Supports et Flexibles <i>Handsets, supports and flexibles</i>	1_64
Barres de Douche <i>Shower kits</i>	1_70
Pommes de Douche <i>Shower heads</i>	1_74
Accessoires Salle de Bain <i>Bathroom accessories</i>	1_80
Eviers Chef, Eviers Chef Design et Eviers Chef Slim <i>Sink mixers</i>	1_90
Eviers Douchettes Extractible et Accessoires de Cuisine <i>Pull-out sink mixer and Kitchen accessories</i>	1_96
Eviers Classique <i>Sink mixers</i>	1_100
Eviers Façon Inox <i>Sink mixers</i>	1_106
Eviers Rabattables <i>Sink mixers with folding spout</i>	1_108
Eviers Eau Purifiée <i>Water quality equipment taps</i>	1_110

Black&White

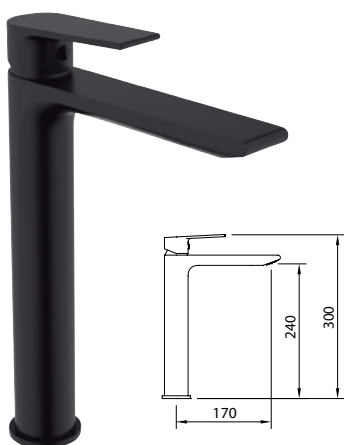

AGORA Xtreme
MITIGEUR LAVABO NOIR MAT 240
Matte black tall basin mixer 240

Mitigeur Lavabo, aérateur orientable, raccords flexibles M-10 3/8" x 370 mm.
Mixer, orientable aerator, flexible hoses M-10 3/8" x 370 mm.

Ref.	€	📦
60707	188,00	8

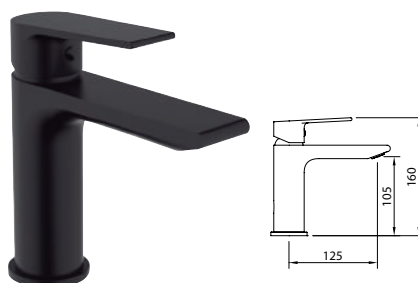

AGORA Xtreme
MITIGEUR LAVABO NOIR MAT 105
Matte black basin mixer 105

Mitigeur Lavabo, aérateur orientable, raccords flexibles M-10 3/8" x 420 mm.
Mixer, orientable aerator, flexible hoses M-10 3/8" x 420 mm.

Ref.	€	📦
60705	144,00	8



START elegance
MITIGEUR LAVABO NOIR MAT 100
Matte black tall basin mixer 100

Mitigeur lavabo, aérateur, raccords flexibles M-10 3/8" x 500 mm.
Mixer, aerator, flexible hoses M-10 3/8" x 500 mm.

Ref.	€	📦
60713	95,00	12

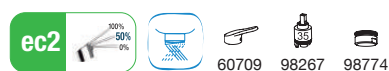

Produits connexes
Related products

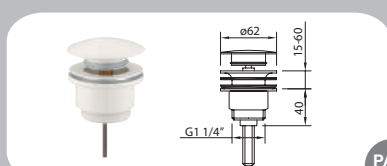

LEO BLANCO MATE _ 60701
Vidage Universel. Métallique
Universal drain quick-clac. Metallic

PAG. 2.60

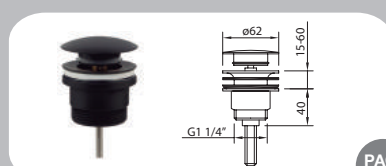

LEO NEGRO MATE _ 60702
Vidage Universel. Métallique
Universal drain quick-clac. Metallic

PAG. 2.60

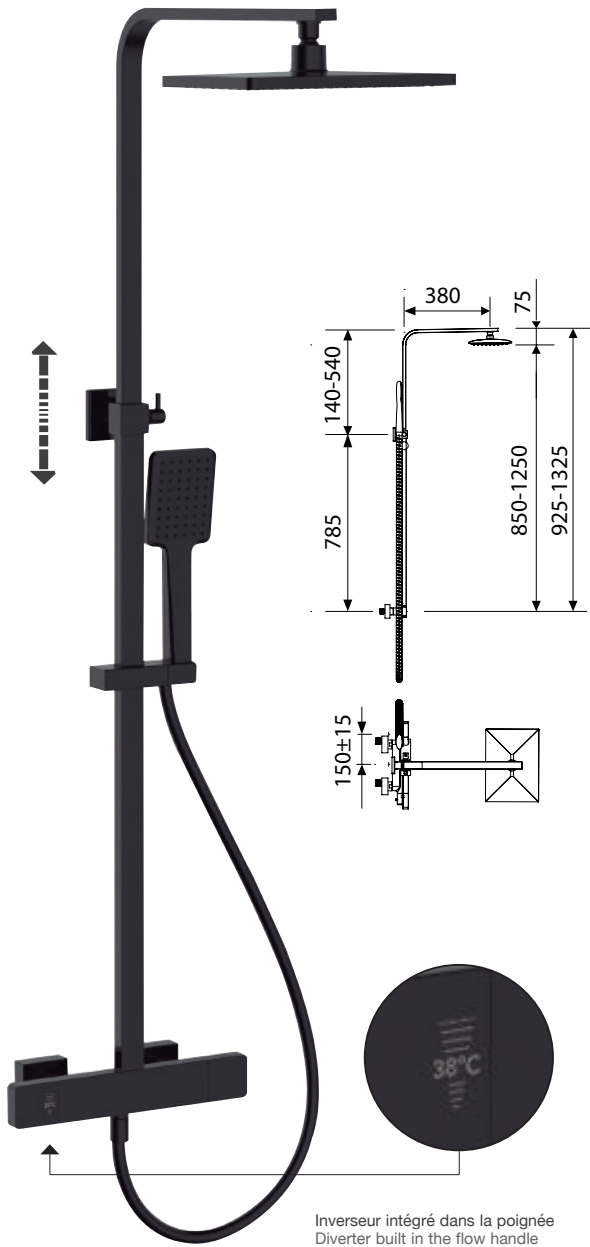

Inverseur intégré dans la poignée
Diverter built in the flow handle

NINE xtreme
COLONNE DE DOUCHE EXTENSIBLE THERMOSTATIQUE
Thermostatic Extensible shower system

Inclus kit de douche | Includes shower kit

Ref.	€	📦
60791	592,00	4



CHEF SLIM
MITIGEUR ÉVIER
Sink mixer

Évier à bec orientable. Livré avec raccords flexibles M-10 3/8" x 370 mm
Mixer with aerator, handset and flexible hoses M-10 3/8" x 370 mm.

Ref.	€	📦
60148	228,00	4

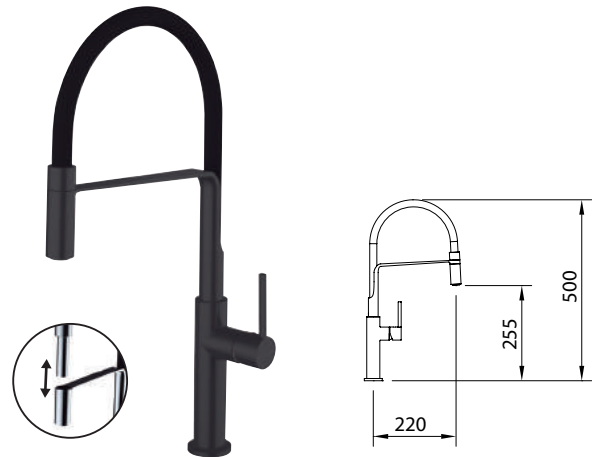

CHEF SLIM
MITIGEUR ÉVIER
Sink mixer

Évier à bec orientable. Livré avec raccords flexibles M-10 3/8" x 370 mm
Mixer with aerator, handset and flexible hoses M-10 3/8" x 370 mm.

Ref.	€	📦
60146	212,00	4



Technologie
Technology



EASYFIX
Facilité d'installation des éviers
Easy sink taps installation

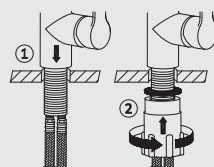

Dispositif permettant un montage sans besoin d'outil spécifique.

Device that allows the assembly by hand, without any tools.

Black&White

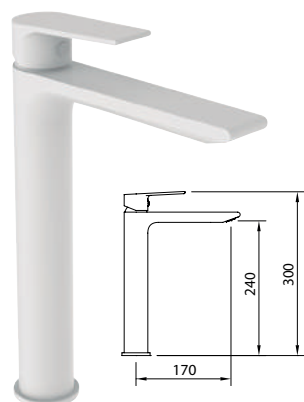

AGORA xtreme
MITIGEUR LAVABO BLANC MAT 240
Matte white tall basin mixer 240

Mitigeur Lavabo, aérateur orientable, raccords flexibles M-10 3/8" x 370 mm.
Mixer, orientable aerator, flexible hoses M-10 3/8" x 370 mm.

Ref.	€	📦
60706	188,00	8

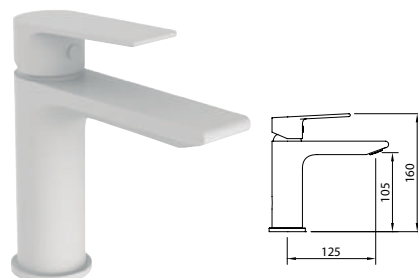

AGORA xtreme
MITIGEUR LAVABO BLANC MAT 105
Matte white basin mixer 105

Mitigeur Lavabo, aérateur orientable, raccords flexibles M-10 3/8" x 420 mm.
Mixer, orientable aerator, flexible hoses M-10 3/8" x 420 mm.

Ref.	€	📦
60704	144,00	8

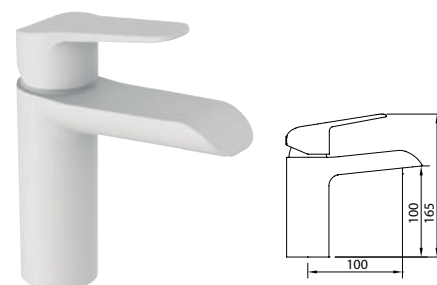

START elegance
MITIGEUR LAVABO BLANC MAT 100
Matte white tall basin mixer 100

Mitigeur lavabo, aérateur, raccords flexibles M-10 3/8" x 500 mm.
Mixer, aerator, flexible hoses M-10 3/8" x 500 mm.

Ref.	€	📦
60712	95,00	12



Produits connexes
Related products

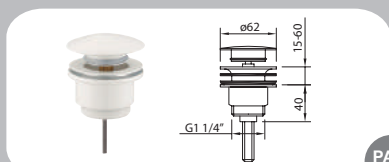

LEO BLANCO MATE _ 60701
Vidage Universel. Métallique
Universal drain quick-clac. Metallic

PAG. 2.60

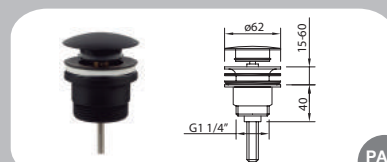

LEO NEGRO MATE _ 60702
Vidage Universel. Métallique
Universal drain quick-clac. Metallic

PAG. 2.60

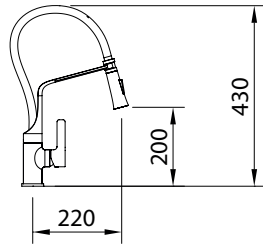

CHEF 6
MITIGEUR ÉVIER DOUCHETTE
Sink mixer

Évier à bec orientable, douchette avec poussoir pré lavage. Livré avec raccords flexibles M-10 3/8" x 370 mm
Mixer with aerator, swivel spout, handset and flexible hoses M-10 3/8" x 370 mm.

Finition blanc-Chrome.
White-Chrome finish.

CHEF 6 - 99733
CHEF SLIM - 60147

Ref.	€	
99733	254,00	4

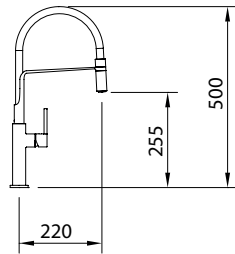

CHEF SLIM
MITIGEUR ÉVIER
Sink mixer

Évier à bec orientable. Livré avec raccords flexibles M-10 3/8" x 370 mm
Mixer with aerator, handset and flexible hoses M-10 3/8" x 370 mm.

Ref.	€	
60147	228,00	4

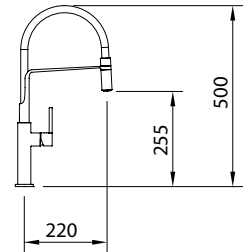

CHEF SLIM
MITIGEUR ÉVIER
Sink mixer

Évier à bec orientable. Livré avec raccords flexibles M-10 3/8" x 370 mm
Mixer with aerator, handset and flexible hoses M-10 3/8" x 370 mm.

Ref.	€	
60145	212,00	4



Technologie
Technology



EASYFIX
Facilité d'installation des éviers
Easy sink taps installation

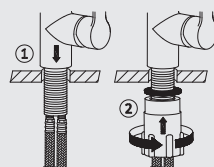

Dispositif permettant un montage sans besoin d'outil spécifique.

Device that allows the assembly by hand, without any tools.

Aude

Esprit libre
Free spirit

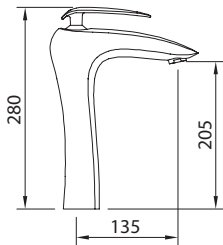

MITIGEUR LAVABO 205
Tall basin mixer 205

Mitigeur Lavabo bec haut, aérateur, raccords flexibles M-10 3/8" x 370 mm.
Tall mixer, aerator, flexible hoses M-10 3/8" x 370 mm.

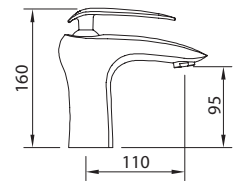

MITIGEUR LAVABO 95
Basin mixer 95

Mitigeur Lavabo, aérateur, raccords flexibles M-10 3/8" x 370 mm.
Mixer, aerator, flexible hoses M-10 3/8" x 370 mm.

	Ref.	€	📦
	97811	295,00	6
	97842	303,00	6
	97843	311,00	6

	Ref.	€	📦
	97810	243,00	8
	97840	251,00	8
	97841	259,00	8



Produits connexes
Related products



elegance _ 99451
Accessoires de salle de bain
Bathroom accessories



VELA _ 97395 96255
Vidage métallique
Drain quick-clac metallic



ELEGANCE _ 96174
Siphon laiton
Brass bottle trap



DESIGN _ 40010
Robinet d'équerre
Angle Valve

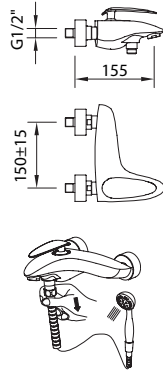

MITIGEUR BAIN-DOUCHE
Bath-shower mixer

Mitigeur bain-douche, aérateur, inverseur intégré
Bath-shower mixer with aerator, hidden diverter.



REF.
97142
97670
96942

Ref.	€	📦
97813	394,00	6
ACS 97846	363,00	6

Sans kit de douche
Without shower kit



95163 97372 96200 97817

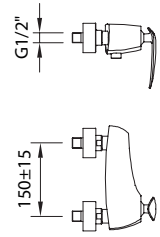

MITIGEUR DOUCHE
Shower mixer

Mitigeur douche
Shower mixer.



REF.
97142
97670
96942

Ref.	€	📦
97814	348,00	6
ACS 97847	317,00	6

Sans kit de douche
Without shower kit



95163 97372

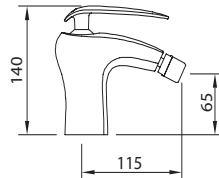

MITIGEUR BIDET
Bidet mixer

Mitigeur bidet, aérateur rotule, raccords flexibles M-10 3/8" x 370 mm.
Mixer, swivel aerator, flexible hoses M-10 3/8" x 370 mm.

Ref.	€	📦
ACS 97812	243,00	6
ACS 97844	251,00	6
ACS 97845	259,00	6



95163 97372 90026

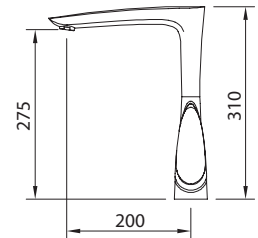

MITIGEUR ÉVIER
Sink mixer

Mitigeur évier bec orientable, aérateur, raccords flexibles M-10 3/8" x 370 mm.
Mixer with aerator, swivel cast spout, flexible hoses M-10 3/8" x 370 mm.

Ref.	€	📦
ACS 97815	295,00	8



95164 97372 97688 90025

Technologie
Technology

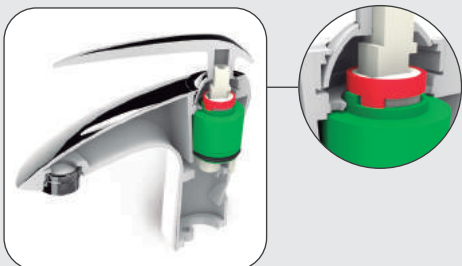

SYSTÈME TERMOLIMIT DE LIMITATION DE TEMPÉRATURE. Economisez l'énergie et protégez les plus petits des brûlures.

TermoLimit system, limits the temperature. Save energy and protect children against scalding.

Une bague est placée sur la partie supérieure de la cartouche pour limiter l'ouverture latérale de la manette.
The ring located in the cartridge allows us to limit the opening of the faucet lever.

Selene Inspiration et design Inspiration and design

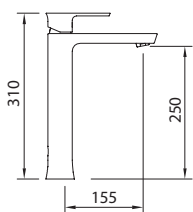

MITIGEUR LAVABO 250 Tall basin mixer 250

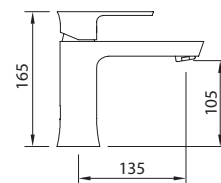

Mitigeur Lavabo bec haut, aérateur, raccords flexibles M-10 3/8" x 370 mm.
Tall mixer, aerator, flexible hoses M-10 3/8" x 370 mm.

Ref.	€	📦
 98009	295,00	8



MITIGEUR LAVABO 105 Basin mixer 105

Mitigeur Lavabo, aérateur, raccords flexibles M-10 3/8" x 370 mm.
Mixer, aerator, flexible hoses M-10 3/8" x 370 mm.

Ref.	€	📦
 98010	243,00	8
 98017	251,00	8
 98018	259,00	8



Produits connexes Related products



PAG. 1.80

VENTU _ 99470
Accessoires de salle de bain
Bathroom accessories



PAG. 2.60

HYDRA _ 98675
Vidage Universel
Universal drain quick-clac



PAG. 2.61

XTREME _ 96173
Siphon laiton
Brass bottle trap

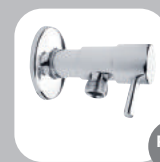

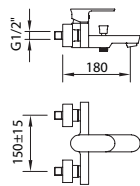

PAG. 2.61

DESIGN _ 40010
Robinet d'angle
Angle Valve



MITIGEUR BAIN-DOUCHE
Bath-shower mixer

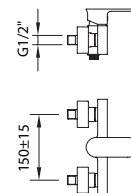
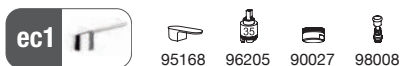

Mitigeur bain-douche, aérateur, inverseur automatique.
Bath-shower mixer with aerator, automatic diverter.

	Ref.	€	☐
	REF. 96786 97670 96413	98012 394,00	8
Sans kit de douche Without shower kit	 98150	363,00	8



MITIGEUR DOUCHE
Shower mixer





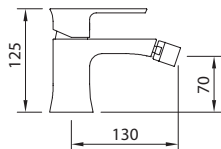

Mitigeur douche.
Shower mixer.

	Ref.	€	☐
	REF. 96786 97670 96413	98013 348,00	8
Sans kit de douche Without shower kit	 98151	317,00	8



MITIGEUR BIDET
Bidet mixer

Mitigeur bidet, aérateur rotule, raccords flexibles M-10 3/8" x 370 mm.
Mixer, swivel aerator, flexible hoses M-10 3/8" x 370 mm.

	Ref.	€	☐
	 98011	243,00	6
	 98019	251,00	6
	 98020	259,00	6

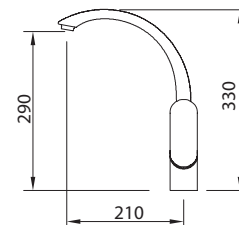

MITIGEUR ÉVIER
Sink mixer

Mitigeur évier bec orientable, aérateur, raccords flexibles M-10 3/8" x 370 mm.
Mixer with aerator, swivel cast spout, flexible hoses M-10 3/8" x 370 mm.

	Ref.	€	☐
	 98014	270,00	8



POLISSAGE MIROIR
Mirror Effect

L'application de la technologie CNC au dégrossissage et polissage de la gamme Seline permet l'obtention d'une surface plane à effet miroir.
The surface polished for Seline range is produced using the CNC technology, getting perfect flat sides with mirror effect.

Bimini

Transition naturelle
Natural transition

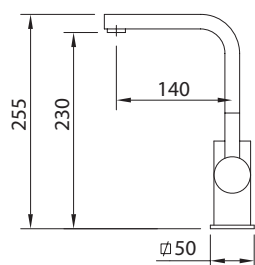

MITIGEUR LAVABO 230
Tall basin mixer 230

Mitigeur lavabo haut, bec orientable, aérateur, raccords flexibles M-10 3/8" x 370 mm.
Tall mixer, aerator, swivel spout, flexible hoses M-10 3/8" x 370 mm.

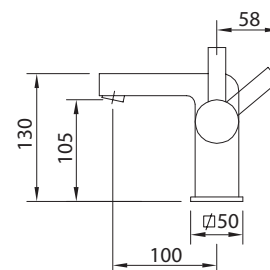

MITIGEUR LAVABO 105
Basin mixer 105

Mitigeur Lavabo, aérateur, raccords flexibles M-10 3/8" x 370 mm.
Mixer, aerator, flexible hoses M-10 3/8" x 370 mm.

	Ref.	€	📦
	97042	243,00	8
	97852	251,00	8
	97132	259,00	8



95165 97371 96202

	Ref.	€	📦
	97041	243,00	8
	97850	251,00	8
	97131	259,00	8



95165 97371 90025

Produits connexes
Related products



PAG. 1.83

XTREME _ 98655
Accessoires de salle de bain
Bathroom accessories



PAG. 2.60

HYDRA _ 98675
Vidage Universel
Universal drain quick-clac



PAG. 2.61

XTREME _ 96173
Siphon laiton
Brass bottle trap



PAG. 2.61

BIMINI _ 97106
Robinet d'angle
Angle Valve

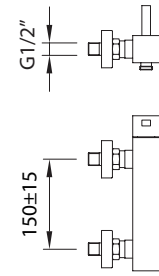
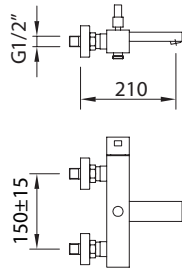

MITIGEUR BAIN-DOUCHE
Bath-Shower mixer

Mitigeur bain-douche, aérateur, inverseur automatique.
Bath-shower mixer with aerator, automatic diverter.

REF.	€	📦
96786 96770 97112	394,00	4

ACS	Ref.	€	📦
	97853	363,00	4

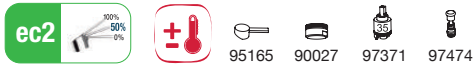

MITIGEUR DOUCHE
Shower mixer

Mitigeur douche.
Shower mixer.

REF.	€	📦
96786 96770 97112	348,00	6

ACS	Ref.	€	📦
	97854	317,00	8

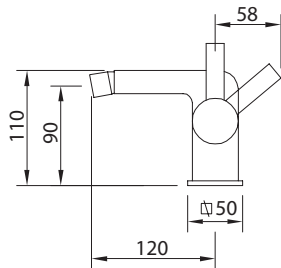

MITIGEUR BIDET
Bidet mixer

Mitigeur bidet, aérateur rotule, raccords flexibles M-10 3/8" x 370 mm.
Mixer, swivel aerator, flexible hoses M-10 3/8" x 370 mm.

Ref.	€	📦
97043	243,00	8
97851	251,00	8
97133	259,00	8

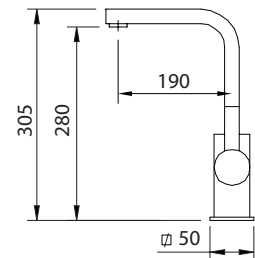

MITIGEUR ÉVIER
Sink mixer

Mitigeur évier bec orientable, aérateur, raccords flexibles M-10 3/8" x 370 mm.
Mixer with aerator, swivel tube spout, flexible hoses M-10 3/8" x 370 mm.

Ref.	€	📦
97046	233,00	8



Technologie
Technology



SYSTÈME ECONATURE.
ÉCONOMIE D'EAU. DEUX POSITIONS D'OUVERTURE DE LA POIGNÉE.

*Econature system.
Save water. Two positions of opening the handle.*

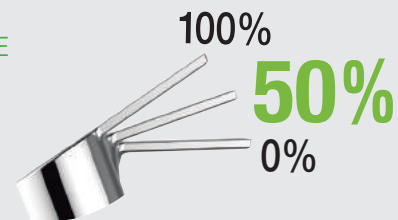

Saona Slim Lignes pures

Pure lines



MITIGEUR LAVABO 250
Tall basin mixer 250

Mitigeur Lavabo, aérateur orientable, raccords flexibles M-10 3/8" x 370 mm.

Mixer, orientable aerator, flexible hoses M-10 3/8" x 370 mm.

Ref.	€	📦
60118	199,00	8

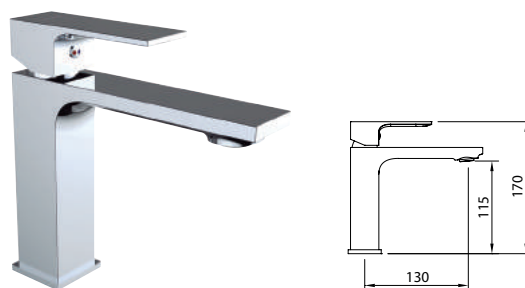

MITIGEUR LAVABO 115
Basin mixer 115

Mitigeur Lavabo, aérateur orientable, raccords flexibles M-10 3/8" x 500 mm.

Mixer, orientable aerator, flexible hoses M-10 3/8" x 500 mm.

	Ref.	€	📦
	60115	147,00	8
	60116	155,00	8
	60117	163,00	8



Produits connexes
Related products



PAG. 1.83

XTREME _ 98655
Accessoires de salle de bain
Bathroom accessories



PAG. 2.60

HYDRA _ 98675
Vidage Universel
Universal drain quick-clac



PAG. 2.61

XTREME _ 96173
Siphon laiton
Brass bottle trap





PAG. 2.61

BIMINI _ 97106
Robinet d'angle
Angle Valve





MITIGEUR BAIN-DOUCHE
Bath-shower mixer

Mitigeur bain-douche, aérateur orientable, inverseur automatique.
Bath-shower mixer, orientable aerator, automatic diverter.

	Ref.	€	
 REF. 98884 97670 96413	60124	238,00	8
Sans kit de douche Without shower kit	 60125	207,00	8

MITIGEUR DOUCHE
Shower mixer

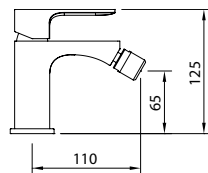
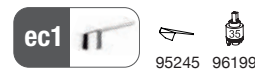

Mitigeur douche.
Shower mixer.

	Ref.	€	
 REF. 98884 97670 96413	60126	202,00	8
Sans kit de douche Without shower kit	 60127	171,00	8



MITIGEUR BIDET
Bidet mixer

Mitigeur bidet, aérateur rotule, raccords flexibles M-10 3/8" x 420 mm.
Mixer, swivel aerator, flexible hoses M-10 3/8" x 420 mm.

	Ref.	€	
 60121	60121	147,00	8
 60122	60122	155,00	8
 60123	60123	163,00	8

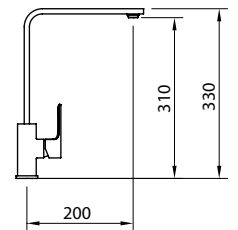

MITIGEUR ÉVIER
Sink mixer

Mitigeur évier bec orientable, aérateur, raccords flexibles M-10 3/8" x 370 mm.
Mixer with aerator, swivel spout, flexible hoses M-10 3/8" x 370 mm.

	Ref.	€	
 60128	60128	177,00	8



AÉRATEUR ORIENTABLE pour plus de confort lors de l'utilisation

Orientable aerator for greater comfort during its use

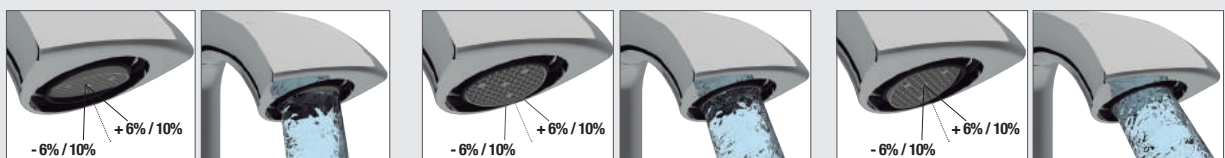

Technologie
Technology

Paula Style unique Own style

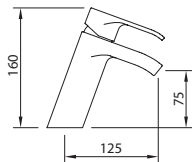

MITIGEUR LAVABO 75 *Basin mixer 75*

Mitigeur Lavabo, aérateur, raccords flexibles M-10 3/8" x 370 mm.
Mixer, aerator, flexible hoses M-10 3/8" x 370 mm.

	Ref.	€	☐
	98197	147,00	8
	98202	155,00	8
	98203	163,00	8

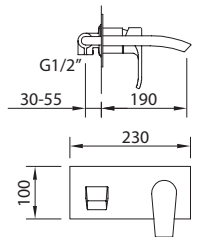
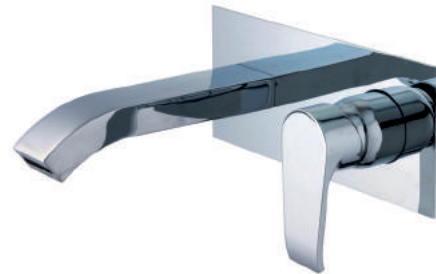

LAVABO À ENCASTRER *Concealed basin mixer*

Mélangeur lavabo encastré, aérateur, bec 190 mm.
Concealed basin, aerator, wall spout length 190 mm.

	Ref.	€	☐
	98413	217,00	6



Produits connexes *Related products*



PAG.
1.82

elegance _ 99451
Accessoires de salle de bain
Bathroom accessories



PAG.
2.60

VELA _ 97395 96255
Vidage métallique
Drain quick-clac metallic



PAG.
2.61

ELEGANCE _ 96174
Siphon laiton
Brass bottle trap



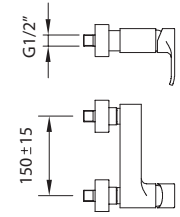
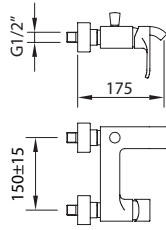

PAG.
2.61

DESIGN _ 40010
Robinet d'angle
Angle Valve





MITIGEUR BAIN-DOUCHE
Bath-shower mixer

Mitigeur bain-douche, aérateur, inverseur automatique.
Bath-shower mixer, aerator, automatic diverter.

	Ref.	€	📦
	REF. 96786 97670 96413		
	98199	220,00	6
Sans kit de douche Without shower kit	 98539	189,00	6

MITIGEUR DOUCHE
Shower mixer



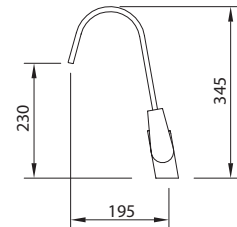
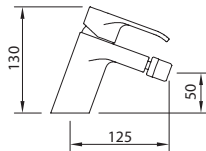

Mitigeur douche.
Shower mixer.

	Ref.	€	📦
	REF. 96786 97670 96413		
	98200	174,00	6
Sans kit de douche Without shower kit	 98540	143,00	6





MITIGEUR BIDET
Bidet mixer

Mitigeur bidet, aérateur rotule, raccords flexibles M-10 3/8" x 370 mm.
Mixer, swivel aerator, flexible hoses M-10 3/8" x 370 mm.

	Ref.	€	📦
	 98198	147,00	8
	 98204	155,00	8
	 98205	163,00	8

MITIGEUR ÉVIER
Sink mixer

Mitigeur évier bec orientable, brise-jet, raccords flexibles M-10 3/8" x 370 mm.
Mixer with water breaker, swivel tube spout, flexible hoses M-10 3/8" x 370 mm.

	Ref.	€	📦
	 98201	177,00	8



DÉMONTAGE AÉRATEUR CACHÉ | Aerator dismantling



Technologie
Technology

Agora *elegance*

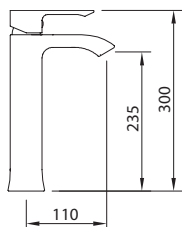

MITIGEUR LAVABO 265 Tall basin mixer 265

Mitigeur Lavabo bec haut, aérateur orientable, raccords flexibles M-10 3/8" x 370 mm.

Mixer, orientable aerator, flexible hoses M-10 3/8" x 370 mm.

Ref.	€	📦
98783	183,00	6

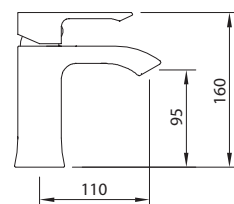

MITIGEUR LAVABO 95 Basin mixer 95

Mitigeur Lavabo, aérateur orientable, raccords flexibles M-10 3/8" x 420 mm.

Mixer, orientable aerator, flexible hoses M-10 3/8" x 420 mm.

Ref.	€	📦
98680	140,00	12
98685	148,00	12
98686	156,00	12



Produits connexes Related products



PAG. 2.34

iclever basin 98703 + 98709
Lavabo encastré
Concealed basin mixer



PAG. 2.60

VELA _ 97395 96255
Vidage métallique
Drain quick-clac metallic



PAG. 2.61

ELEGANCE _ 96174
Siphon laiton
Brass bottle trap

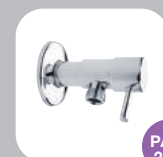

PAG. 2.61

DESIGN _ 40010
Robinet d'equerre
Angle Valve

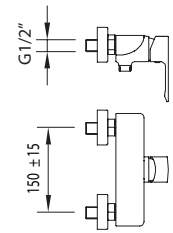
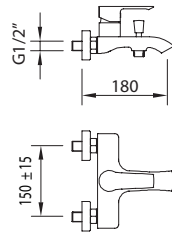

MITIGEUR BAIN-DOUCHE
Bath-shower mixer

Mitigeur bain-douche, aérateur orientable, inverseur automatique.
Bath-shower mixer with orientable aerator, automatic diverter.

REF.	Ref.	€	📦
97142 97670 96942	98682	193,00	8

Sans kit de douche Without shower kit	ACS 98678	172,00	8
--	-----------	--------	---



MITIGEUR DOUCHE
Shower mixer

Mitigeur douche.
Shower mixer.

REF.	Ref.	€	📦
97142 97670 96942	98683	161,00	8

Sans kit de douche Without shower kit	ACS 98679	140,00	8
--	-----------	--------	---

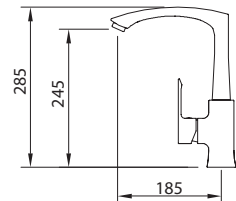
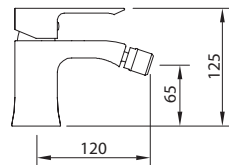

MITIGEUR BIDET
Bidet mixer

Mitigeur bidet, aérateur rotule, raccords flexibles M-10 3/8" x 420 mm.
Mixer, swivel aerator, flexible hoses M-10 3/8" x 420 mm.

Ref.	€	📦
ACS 98681	140,00	12
ACS 98687	148,00	12
ACS 98688	156,00	12



MITIGEUR ÉVIER
Sink mixer

Mitigeur évier bec orientable, aérateur orientable, raccords flexibles M-10 3/8" x 370 mm.
Mixer with orientable aerator, swivel cast spout, flexible hoses M-10 3/8" x 370 mm.

Ref.	€	📦
ACS 98684	169,00	8



AÉRATEUR ORIENTABLE pour plus de confort lors de l'utilisation

Orientable aerator for greater comfort during its use

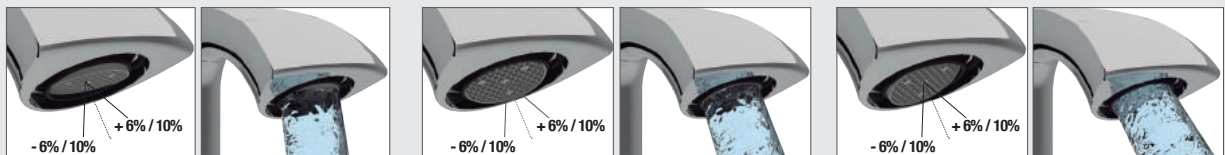

Technologie
Technology

Agora xtreme



MITIGEUR LAVABO 240 Tall basin mixer 240

Mitigeur Lavabo, aérateur orientable, raccords flexibles M-10 3/8" x 370 mm.
Mixer, orientable aerator, flexible hoses M-10 3/8" x 370 mm.

Ref.	€	📦
60103	173,00	8

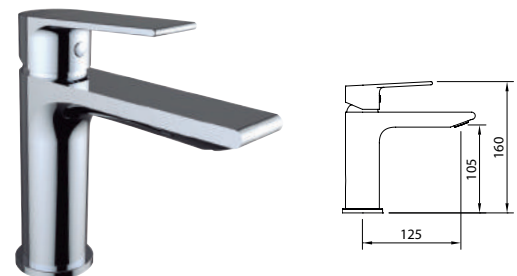

MITIGEUR LAVABO 105 Basin mixer 105

Mitigeur Lavabo, aérateur orientable, raccords flexibles M-10 3/8" x 420 mm.
Mixer, orientable aerator, flexible hoses M-10 3/8" x 420 mm.

	Ref.	€	📦
	60100	129,00	8
	60101	137,00	8
	60102	145,00	8



Produits connexes Related products



PAG. 2.60

LEO BLANCO MATE _ 60701
Vidage Universel. Métallique
Universal drain quick-clac. Metallic



PAG. 2.60

LEO NEGRO MATE _ 60702
Vidage Universel. Métallique
Universal drain quick-clac. Metallic



PAG. 2.61

XTREME _ 96173
Siphon laiton
Brass bottle trap



PAG. 2.61

XTREME _ 97106
Robinet d'equerre
Angle Valve

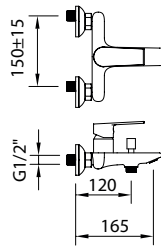
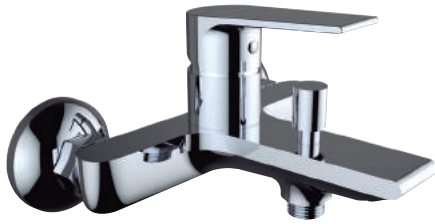

MITIGEUR BAIN-DOUCHE
Bath-shower mixer

Mitigeur bain-douche, aérateur, inverseur automatique.
Bath-shower mixer with aerator, automatic diverter.

REF.	€	
97142 97670 60311	182,00	8
ACS 60109	182,00	8
Sans kit de douche Without shower kit	ACS 60110	161,00 8

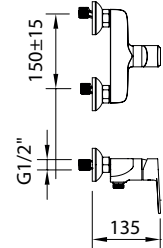

MITIGEUR DOUCHE
Shower mixer

Mitigeur douche.
Shower mixer.

REF.	€	
97142 97670 60311	151,00	8
ACS 60111	151,00	8
Sans kit de douche Without shower kit	ACS 60112	130,00 8

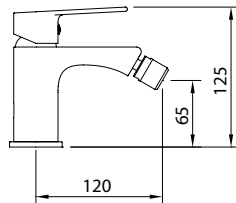

MITIGEUR BIDET
Bidet mixer

Mitigeur bidet, aérateur rotule, raccords flexibles M-10 3/8" x 370 mm.
Mixer, swivel aerator, flexible hoses M-10 3/8" x 370 mm.

Ref.	€	
ACS 60106	129,00	8
ACS 60107	137,00	8
ACS 60108	145,00	8

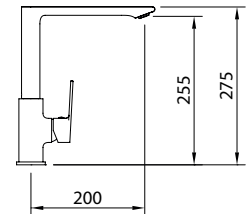

MITIGEUR ÉVIER
Sink mixer

Mitigeur évier bec orientable, aérateur, raccords flexibles M-10 3/8" x 420 mm.
Mixer with aerator, swivel cast spout, flexible hoses M-10 3/8" x 420 mm.

Ref.	€	
ACS 60113	169,00	-



Technologie
Technology



SYSTÈME ECONATURE.
ÉCONOMIE D'EAU. DEUX POSITIONS D'OUVERTURE DE LA POIGNÉE.

Econature system.
Save water. Two positions of opening the handle.

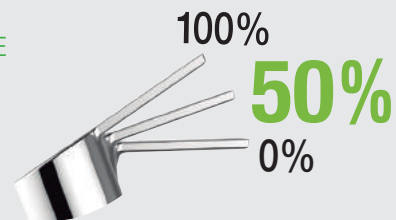

Artic xtreme

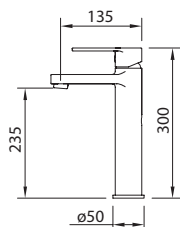

MITIGEUR LAVABO 235 Tall basin mixer 235

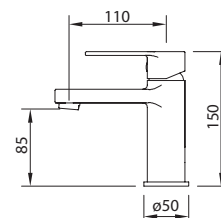

Mitigeur Lavabo bec haut, aérateur, raccords flexibles M-10 3/8" x 370 mm.
Mixer, aerator, flexible hoses M-10 3/8" x 370 mm.

Ref.	€	📦
 98784	152,00	6



MITIGEUR LAVABO 85 Basin mixer 85

Mitigeur Lavabo, aérateur, raccords flexibles M-10 3/8" x 420 mm.
Mixer, aerator, flexible hoses M-10 3/8" x 420 mm.

	Ref.	€	📦
	98690	111,00	12
	98695	119,00	12
	98696	127,00	12



Produits connexes Related products



iclever basin _ 98703 + 98710
Lavabo encastré
Concealed basin mixer

PAG. 2.34



VELA _ 97395 96255
Vidage métallique
Drain quick-clac metallic

PAG. 2.60



ELEGANCE _ 96174
Siphon laiton
Brass bottle trap

PAG. 2.61

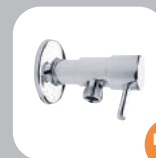

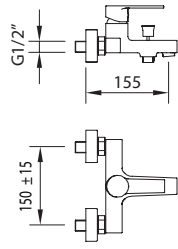

DESIGN _ 40010
Robinnet d'angle
Angle Valve

PAG. 2.61



MITIGEUR BAIN-DOUCHE
Bath-shower mixer

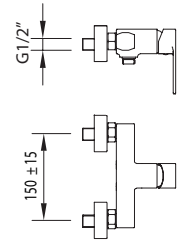

Mitigeur bain-douche, aérateur, inverseur automatique.
Bath-shower mixer, aerator, automatic diverter.

	Ref.	€	☐
 REF. 90796 97670 98208	98692	158,00	8
Sans kit de douche Without shower kit	 98699	137,00	8



MITIGEUR DOUCHE
Shower mixer

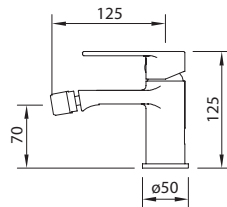

Mitigeur douche.
Shower mixer.

	Ref.	€	☐
 REF. 90796 97670 98208	98693	127,00	8
Sans kit de douche Without shower kit	 98700	106,00	8



MITIGEUR BIDET
Bidet mixer

Mitigeur bidet, aérateur rotule, raccords flexibles M-10 3/8" x 420 mm.
Mixer, swivel aerator, flexible hoses M-10 3/8" x 420 mm.

	Ref.	€	☐
	98691	111,00	12
	98697	119,00	12
	98698	127,00	12

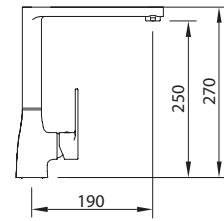
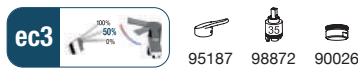

MITIGEUR ÉVIER
Sink mixer

Mitigeur évier bec orientable, aérateur, raccords flexibles M-10 3/8" x 370 mm.
Mixer with aerator, swivel cast spout, flexible hoses M-10 3/8" x 370 mm.

	Ref.	€	☐
	98694	166,00	8



Technologie
Technology



COLD OPEN. SYSTÈME D'OUVERTURE EN EAU FROIDE POUR FAIRE DES ÉCONOMIES D'ÉNERGIE.

*Cold Open system. It opens in cold position.
You save energy.*



Artic urban



MITIGEUR LAVABO 250
Tall basin mixer 250

Mitigeur Lavabo bec haut, aérateur, raccords flexibles M-10 3/8" x 600 mm.
Mixer, aerator, flexible hoses M-10 3/8" x 600 mm.

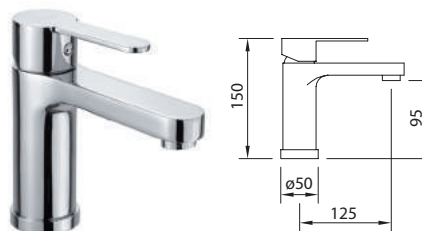

MITIGEUR LAVABO 95
Basin mixer 95

Mitigeur Lavabo, aérateur, raccords flexibles M-10 3/8" x 420 mm.
Mixer, aerator, flexible hoses M-10 3/8" x 420 mm.

	Ref.	€	📦
	ACS 98103	175,00	12
	ACS 98112	183,00	12
	ACS 98111	191,00	12



	Ref.	€	📦
	ACS 98102	131,00	12
	ACS 98110	139,00	12
	ACS 98109	147,00	12



Produits connexes
Related products



urban_99459
Accessoires de salle de bain
Bathroom accessories



VELA_97395_96255
Vidage métallique
Drain quick-clac metallic



ELEGANCE_96174
Siphon laiton
Brass bottle trap

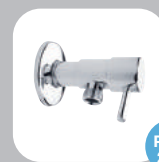

DESIGN_40010
Robinet d'angle
Angle Valve

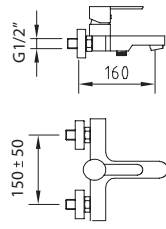

MITIGEUR BAIN-DOUCHE
Bath-shower mixer

Mitigeur bain-douche, aérateur, inverseur intégré.
Bath-shower mixer, aerator, hidden diverter.



Ref.	€	☐
98105	179,00	8

Sans kit de douche
Without shower kit

Ref.	€	☐
98541	158,00	8

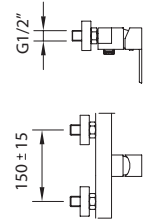

MITIGEUR DOUCHE
Shower mixer

Mitigeur douche.
Shower mixer.



Ref.	€	☐
98106	148,00	8

Sans kit de douche
Without shower kit

Ref.	€	☐
98542	127,00	8

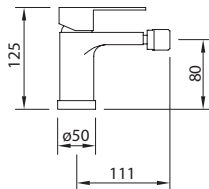
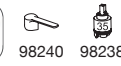

MITIGEUR BIDET
Bidet mixer

Mitigeur bidet, aérateur rotule, raccords flexibles M-10 3/8" x 420 mm.
Mixer, swivel aerator, flexible hoses M-10 3/8" x 420 mm.

Ref.	€	☐
ACS 98104	131,00	12
ACS 98114	139,00	12
ACS 98113	147,00	12

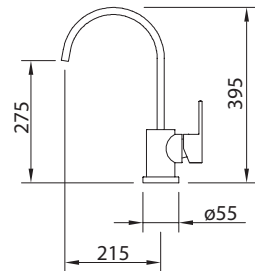

MITIGEUR ÉVIER
Sink mixer

Mitigeur évier bec orientable, aérateur, raccords flexibles M-10 3/8" x 420 mm.
Mixer with aerator, swivel tube spout, flexible hoses M-10 3/8" x 420 mm.

Ref.	€	☐
ACS 98107	166,00	5



Technologie
Technology

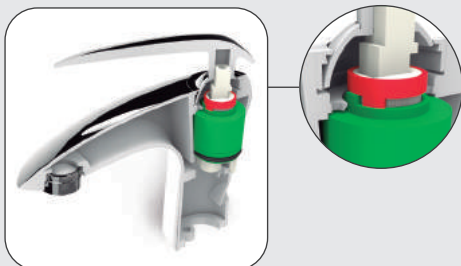

SYSTÈME TERMOLIMIT DE LIMITATION DE TEMPÉRATURE. Economisez l'énergie et protégez les plus petits des brûlures.

TermoLimit system, limits the temperature. Save energy and protect children against scalding.

Une bague est placée sur la partie supérieure de la cartouche pour limiter l'ouverture latérale de la manette.
The ring located in the cartridge allows us to limit the opening of the faucet lever.

Caiman *elegance*

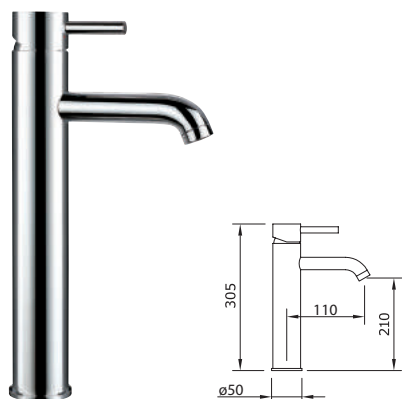

MITIGEUR LAVABO 210 Tall basin mixer 210

Mitigeur Lavabo bec haut, aérateur, raccords flexibles M-10 3/8" x 600 mm.
Mixer, aerator, flexible hoses M-10 3/8" x 600 mm.

Ref.	€	📦
97065	188,00	6

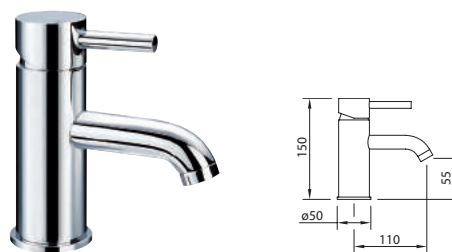
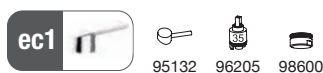

MITIGEUR LAVABO 55 Basin mixer 55

Mitigeur Lavabo, aérateur, raccords flexibles M-10 3/8" x 370 mm.
Mixer, aerator, flexible hoses M-10 3/8" x 370 mm.

Ref.	€	📦
97061	142,00	8
97866	150,00	8
97135	158,00	8

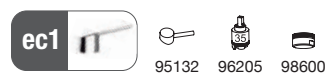

Produits connexes Related products



PAG. 1.82

elegance _ 99451
Accessoires de salle de bain
Bathroom accessories



PAG. 2.60

VELA _ 97395_96255
Vidage métallique
Drain quick-clac metallic



PAG. 2.61

ELEGANCE _ 96174
Siphon laiton
Brass bottle trap

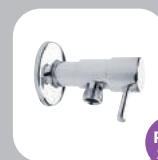

PAG. 2.61

DESIGN _ 40010
Robinet d'angle
Angle Valve



MITIGEUR ÉVIER
Sink mixer

Mitigeur évier bec orientable, aérateur, raccords flexibles M-10 3/8" x 370 mm.
Mixer with aerator, swivel tube spout, flexible hoses M-10 3/8" x 370 mm.

Ref.	€	📦
ACS 97086	168,00	8



MITIGEUR ÉVIER
Sink mixer

Mitigeur évier bec orientable, aérateur, raccords flexibles M-10 3/8" x 600 mm.
Mixer, aerator swivel spout, flexible hoses M-10 3/8" x 600 mm.

Ref.	€	📦
ACS 60161	155,00	20

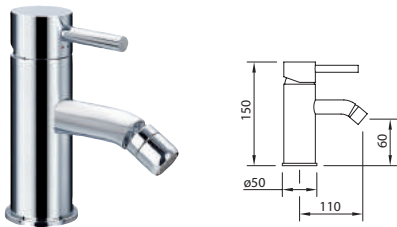

MITIGEUR BIDET
Bidet mixer

Mitigeur bidet, aérateur rotule, raccords flexibles M-10 3/8" x 370 mm.
Mixer, swivel aerator, flexible hoses M-10 3/8" x 370 mm.

Ref.	€	📦
ACS 97062	142,00	8
ACS 97868	150,00	8
ACS 97136	158,00	8

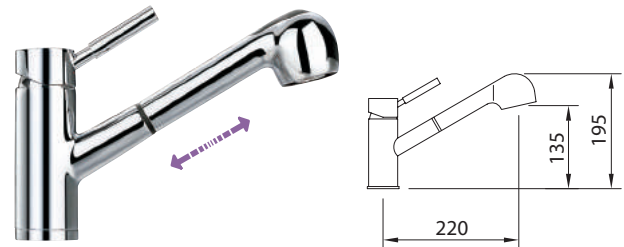
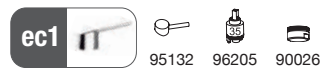

MITIGEUR ÉVIER DOUCHETTE EXTRACTIBLE
Pull-out sink mixer

Mitigeur évier bec orientable, aérateur, raccords flexibles M-10 3/8" x 370 mm.
Mixer with aerator, swivel spout, flexible hoses M-10 3/8" x 370 mm.

Ref.	€	📦
ACS 97069	199,00	8

Inclus
Includes

Extractible 90794	1,50 m 96117
-------------------	--------------



iclever_98703 + 98707
Lavabo encastré
Concealed basin mixer



iclever_2_98711+98715
Douche encastré 1 voie
Concealed bath-shower 1 outlet diverter



iclever_2_98711+98730
Douche encastré 2 voies
Concealed bath-shower 2 outlet diverter



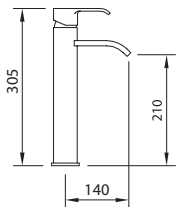

ACCESSOIRE_90794
Douchette cuisine
Pull-out handshower for sink mixer

Caiman xtreme



MITIGEUR LAVABO 210 Basin mixer 210

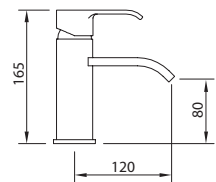

Mitigeur lavabo bec haut, brise-jet, raccords flexibles M-10 3/8" x 370 mm.
Tall mixer, water breaker, flexible hoses M-10 3/8" x 370 mm.

	Ref.	€	Q
	98186	173,00	6
	98193	181,00	6
	98194	189,00	6



MITIGEUR LAVABO 80 Basin mixer 80

Mitigeur lavabo, brise-jet, raccords flexibles M-10 3/8" x 370 mm.
Basin mixer, water breaker, flexible hoses M-10 3/8" x 370 mm.

	Ref.	€	Q
	98185	126,00	8
	98191	134,00	8
	98192	142,00	8



Produits connexes Related products



PAG. 1.83

Xtreme _ 98655
Accessoires de salle de bain
Bathroom accessories



PAG. 2.60

VELA _ 97395 96255
Vidage métallique
Drain quick-clac metallic



PAG. 2.61

ELEGANCE _ 96174
Siphon laiton
Brass bottle trap



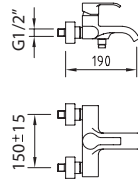

PAG. 2.61

DESIGN _ 40010
Robinet d'angle
Angle Valve



MITIGEUR BAIN-DOUCHE
Bath-shower mixer

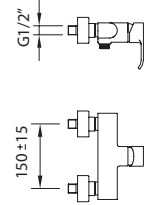
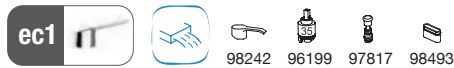

Mitigeur bain-douche, aérateur, inverseur intégré.
Bath-shower mixer, aerator, hidden diverter.

	Ref.	€	☐
 REF. 90796 97670 96458	98188	194,00	8
Sans kit de douche Without shower kit	 98543	173,00	8



MITIGEUR DOUCHE
Shower mixer

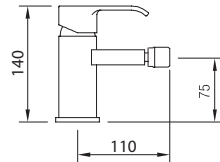

Mitigeur douche.
Shower mixer.

	Ref.	€	☐
 REF. 90796 97670 96458	98189	162,00	6
Sans kit de douche Without shower kit	 98544	141,00	6



MITIGEUR BIDET
Bidet mixer

Mitigeur bidet, aérateur rotule, raccords flexibles M-10 3/8" x 370 mm.
Mixer, swivel aerator, flexible hoses M-10 3/8" x 370 mm.

	Ref.	€	☐
 98187	98187	126,00	8
 98195	98195	134,00	8
 98196	98196	142,00	8

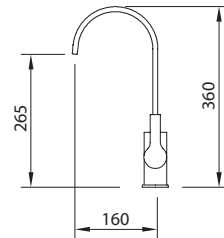

MITIGEUR ÉVIER
Sink mixer

Mitigeur évier bec orientable, aérateur, raccords flexibles M-10 3/8" x 370 mm.
Mixer with aerator, swivel spout, flexible hoses M-10 3/8" x 370 mm.

	Ref.	€	☐
 98190	98190	155,00	8



Technologie
Technology



HIDE DIVERTER
Inverseur Design
Design diverter

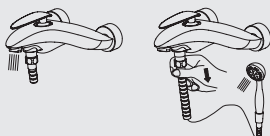

Les nouvelles séries AUDE, ARTIC URBAN et CAIMAN XTREME brevetées utilisent un inverseur innovateur, mélange d'esthétique et de fonctionnalité, où l'inverseur est invisible. Pour l'actionner, il suffit de tirer le flexible de douche vers le bas.

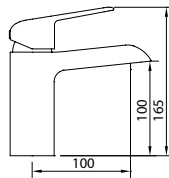

The series AUDE, ARTIC URBAN and CAIMAN XTREME uses a new diverter, mixing style and function, where the diverter is hidden.
When the hose bib is pulled out vertically you do the change.

Start *elegance*



MITIGEUR LAVABO 100 Tall basin mixer 100

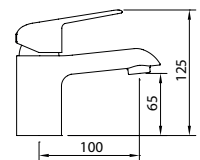

Mitigeur lavabo, aérateur, raccords flexibles M-10 3/8" x 500 mm.
Mixer, aerator, flexible hoses M-10 3/8" x 500 mm.

	Ref.	€	📦
	60173	80,00	8
	60174	88,00	8
	60175	96,00	8



MITIGEUR LAVABO 65 Basin mixer 65

Mitigeur lavabo, aérateur, raccords flexibles M-10 3/8" x 420 mm.
Mixer, aerator, flexible hoses M-10 3/8" x 420 mm.

	Ref.	€	📦
	60170	69,00	12
	60171	77,00	12
	60172	85,00	12



Produits connexes Related products



PEANA _ 60559
Base en plastique
Plastic base

PAG. 2.64



LEO _ 98674
Vidage Universel
Universal drain quick-clac

PAG. 2.60



METÁLICO _ 99127
Vidage automatique
Pop-up

PAG. 2.60



ELEGANCE _ 96174
Siphon laiton
Brass bottle trap

PAG. 2.61

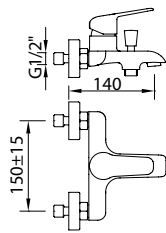

MITIGEUR BAIN-DOUCHE
Bath-shower mixer

Mitigeur bain-douche, aérateur, inverseur automatique.
Bath-shower mixer, aerator, automatic diverter.

REF.	ACS	Ref.	€	📦
98342 97670 60311		60179	120,00	8
Sans kit de douche Without shower kit				
		60180	105,00	8

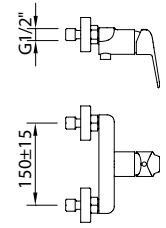

MITIGEUR DOUCHE
Shower mixer

Mitigeur douche.
Shower mixer.

REF.	ACS	Ref.	€	📦
98342 97670 60311		60181	98,00	8
Sans kit de douche Without shower kit				
		60182	83,00	8

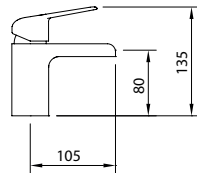

MITIGEUR LAVABO 80
Basin mixer 80

Mitigeur lavabo, brise-jet, raccords flexibles M-10 3/8" x 420 mm.
Mixer, open spout, flexible hoses M-10 3/8" x 420 mm.

REF.	ACS	Ref.	€	📦
		99931	110,00	8
		99932	118,00	8
		99933	126,00	8

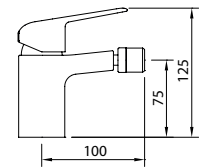

MITIGEUR BIDET
Bidet mixer

Mitigeur bidet, aérateur rotule, raccords flexibles M-10 3/8" x 420 mm.
Mixer, swivel aerator, flexible hoses M-10 3/8" x 420 mm.

REF.	ACS	Ref.	€	📦
		60176	69,00	12
		60177	77,00	12
		60178	85,00	12



elegance _ 99451
Accessoires de salle de bain
Bathroom accessories

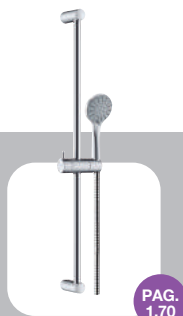

CITY AIR _ 99624
Kit douche
Shower kit

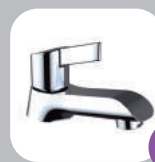

START elegance _ 99392
Lave main
Single washbain tap



START elegance _ 99393
Lave main
Single washbain wall tap

Start elegance

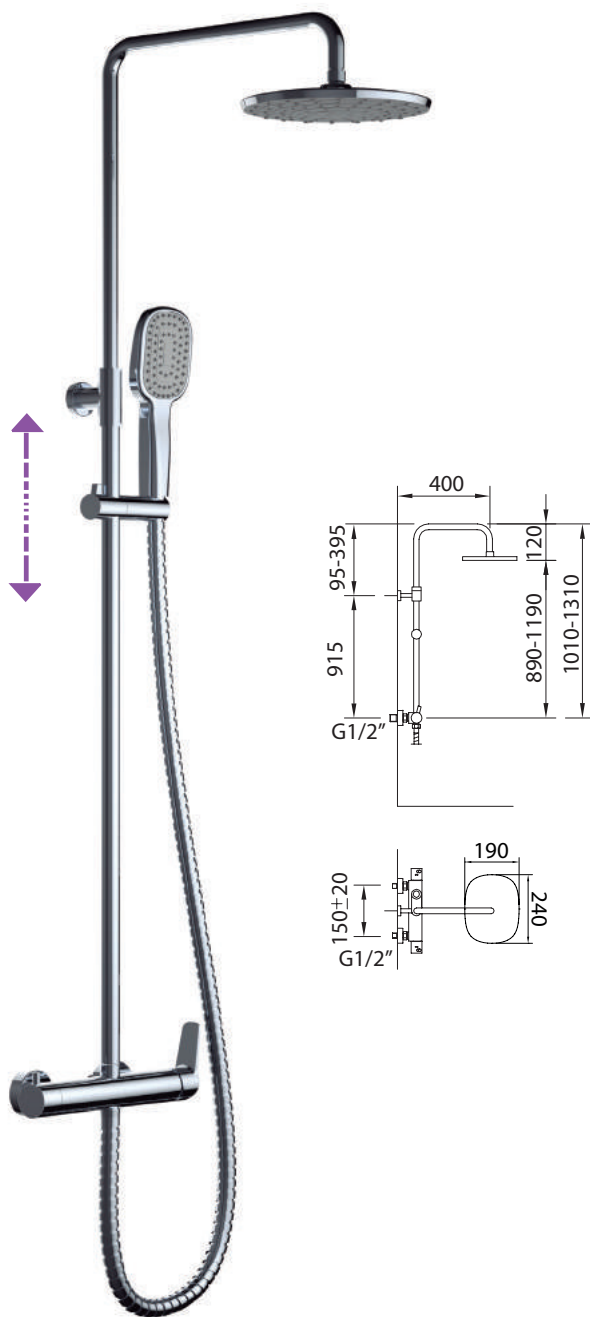

COLONNE DE DOUCHE EXTENSIBLE Extensible shower system

Support douchette coulissant, pomme de douche, douchette et flexible.
Adjustable shower system with diverter built in.

Inclus
Includes



Ref.	€	📦
99646	373,00	-



95237 99543 60313

Technologie
Technology

Tech AIR

Les douchettes et les pommes de douche Clever

sont équipées de la technologie AIR Advanced la plus avancée. L'injection d'air avant la sortie d'eau permet de donner du volume aux gouttes, et d'obtenir une sensation plus douce et confortable sous la douche. Elle permet aussi d'économiser jusqu'à 30% de consommation d'eau et d'énergie.

Clever handsets and shower heads use the advanced technology AIR Advanced. Mixing air with the incoming water reduces the water consumption at least 30%.

-30%
Water reduce

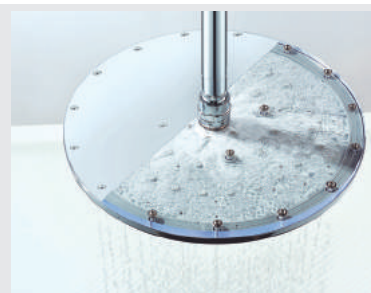

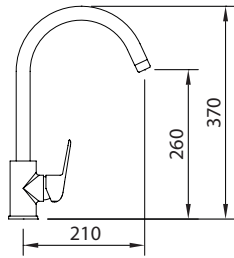

MITIGEUR ÉVIER
Sink mixer

Mitigeur évier bec orientable, aérateur, raccords flexibles M-10 3/8" x 370 mm.
Mixer, aerator, swivel tube spout, flexible hoses M-10 3/8" x 370 mm.

Ref.	€	📦
60183	87,00	8

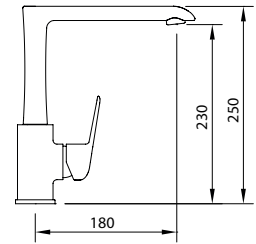

MITIGEUR ÉVIER
Sink mixer

Mitigeur évier bec orientable, aérateur, raccords flexibles M-10 3/8" x 370 mm.
Mixer, aerator, swivel spout, flexible hoses M-10 3/8" x 370 mm.

Ref.	€	📦
60184	106,00	8

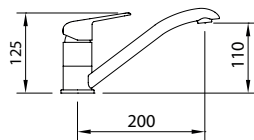

MITIGEUR ÉVIER
Horizontal sink mixer

Mitigeur évier bec orientable, aérateur, raccords flexibles M-10 3/8" x 370 mm.
Sink mixer with aerator, swivel spout, flexible hoses M-10 3/8" x 370 mm.

Cartouche / Cartridge



Ref.	€	📦
99386	87,00	12



Cartouche / Cartridge



Ref.	€	📦
99388	91,00	12

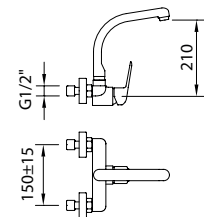

MITIGEUR ÉVIER MURAL
Wall mounted single lever sink mixer

Mitigeur évier mural, bec orientable façonné, aérateur.
Wall mounted mixer with aerator, upper swivel tube spout.

Ref.	€	📦
99389	96,00	12



Technologie
Technology



EASYFIX
Facilité d'installation des éviers
Easy sink taps installation

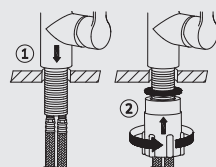

Dispositif permettant un montage sans besoin d'outil spécifique.

Device that allows the assembly by hand, without any tools.

Start xtreme

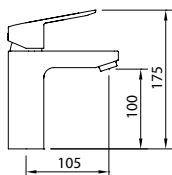
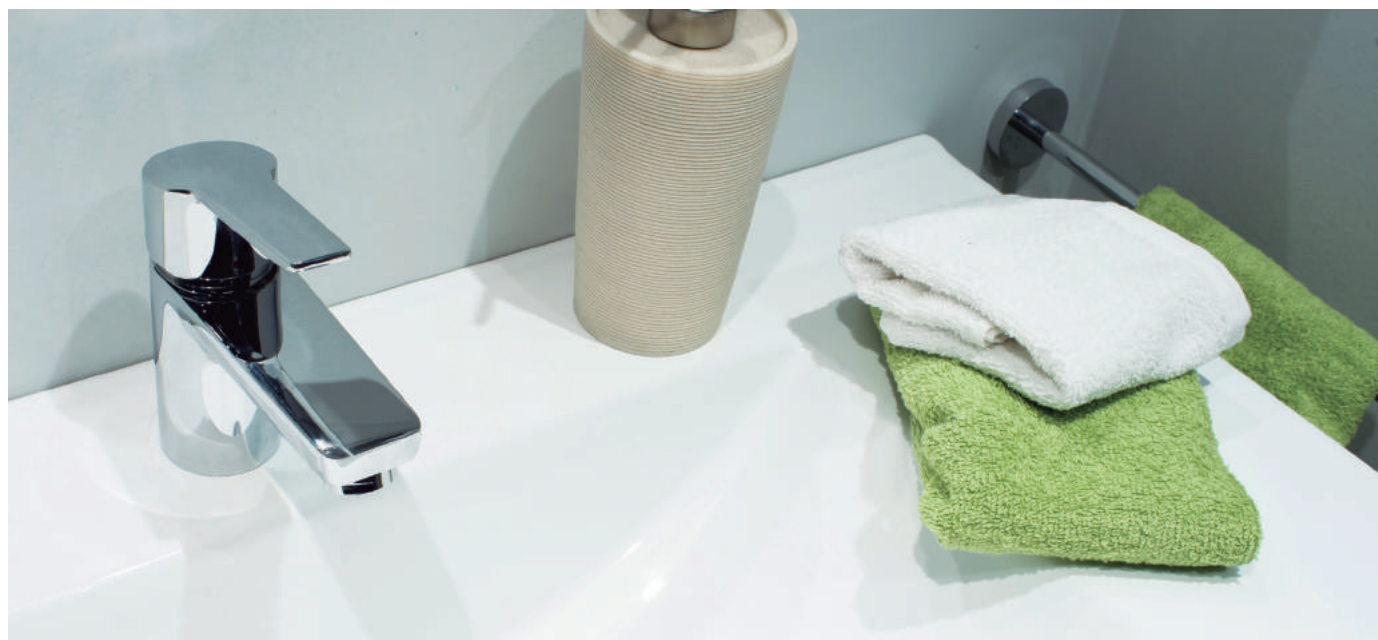

MITIGEUR LAVABO 100
Tall basin mixer 100

Mitigeur lavabo, aérateur, raccords flexibles M-10 3/8" x 500 mm.
Mixer, aerator, flexible hoses M-10 3/8" x 500 mm.

	Ref.	€	☐
	60188	80,00	8
	60189	88,00	8
	60190	96,00	8



95226 99817 99229

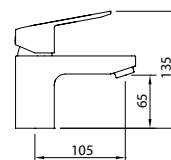

MITIGEUR LAVABO 65
Basin mixer 65

Mitigeur Lavabo, aérateur, raccords flexibles M-10 3/8" x 420 mm.
Mixer, aerator, flexible hoses M-10 3/8" x 420 mm.

	Ref.	€	☐
	60185	69,00	12
	60186	77,00	12
	60187	85,00	12



95226 99817 99229

Produits connexes
Related products



PAG. 2.64

PEANA _ 60559
Base en plastique
Plastic base



PAG. 2.60

HYDRA _ 98675
Vidage Universel
Universal drain quick-clac



PAG. 2.61

XTREME _ 96173
Siphon laiton
Brass bottle trap



PAG. 2.60

METÁLICO _ 99127
Vidage automatique
Pop-up



MITIGEUR BAIN-DOUCHE
Bath-shower mixer

Mitigeur bain-douche, aérateur, inverseur automatique.
Bath-shower mixer, aerator, automatic diverter.

MITIGEUR DOUCHE
Shower mixer

Mitigeur douche.
Shower mixer.

	Ref.	€	📦
	60194	120,00	8
REF. 98342, 97670, 60311			
Sans kit de douche Without shower kit	60195	105,00	8

	Ref.	€	📦
	60196	98,00	8
REF. 98342, 97670, 60311			
Sans kit de douche Without shower kit	60197	83,00	8

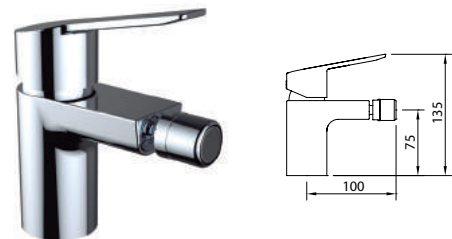
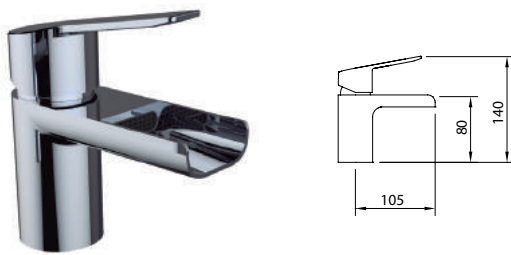

MITIGEUR LAVABO 80
Basin mixer 80

Mitigeur lavabo, brise-jet, raccords flexibles M-10 3/8" x 420 mm.
Mixer, open spout, flexible hoses M-10 3/8" x 420 mm.

MITIGEUR BIDET
Bidet mixer

Mitigeur bidet, aérateur rotule, raccords flexibles M-10 3/8" x 420 mm.
Mixer, swivel aerator, flexible hoses M-10 3/8" x 420 mm.

	Ref.	€	📦
	99928	110,00	8
	99929	118,00	8
	99930	126,00	8

	Ref.	€	📦
	60191	69,00	12
	60192	77,00	12
	60193	85,00	12



xtreme _ 98655
Accessoires de salle de bain
Bathroom accessories

TREND _ 99626
Ensemble barre douche
Sliding bar set

NINE xtreme _ 60133
Mitigeur douche thermostatique
Thermostatic shower mixer

BIMINI _ 97106
Robinet d'equerre
Angle valve

Start xtreme

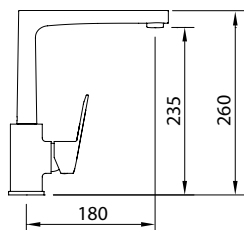

MITIGEUR ÉVIER

Sink mixer

Mitigeur évier bec orientable, aérateur, raccords flexibles M-10 3/8" x 370 mm.

Mixer with aerator, swivel cast spout, flexible hoses M-10 3/8" x 370 mm.

Ref.	€	
ACS 60198	100,00	8



95227 99817 99229

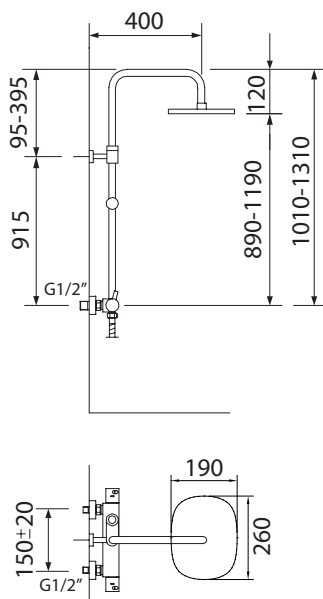

COLONNE DE DOUCHE EXTENSIBLE

Extensible shower system

Support douchette coulissant, pomme de douche, douchette et flexible.

Adjustable shower system with diverter built in.

Inclus
Includes



Trend
99608



Trend
99609



1,75 m
97670



Ceilan
96264



98497

Ref.	€	
99727	373,00	-



95229 99543 60313

Produits connexes
Related products



PAG.
1.68

SILVER HOSE _ 98880
Flexible. Finition argent
Flexible. Silver finish



PAG.
1.68

CEILAN _ 96264
Support coulissant articulé
Articulated holder



PAG.
1.66

STYLE _ 99610
Douchette
Handset



PAG.
1.78

BEAM _ 60303
Pomme de douche ø 230mm
Shower head



99727
Colonne de douche extensible
Shower system



S12 xtreme

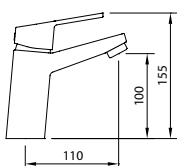

MITIGEUR LAVABO 100 / Tall basin mixer 100

Mitigeur lavabo, aérateur, raccords flexibles M-10 3/8" x 420 mm.
Mixer, aerator, flexible hoses M-10 3/8" x 420 mm.

Cartouche / Cartridge



	Ref.	€	Q
	99823	63,00	12
	99824	71,00	12
	99825	79,00	12



Cartouche / Cartridge



	Ref.	€	Q
	99251	67,00	12
	99252	75,00	12
	99253	83,00	12

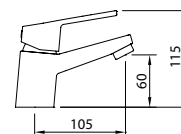

MITIGEUR LAVABO 60 / Basin mixer 60

Mitigeur lavabo, aérateur, raccords flexibles M-10 3/8" x 370 mm.
Mixer with aerator, flexible hoses M-10 3/8" x 370 mm.

Cartouche / Cartridge



	Ref.	€	Q
	99820	53,00	12
	99821	61,00	12
	99822	69,00	12



Cartouche / Cartridge



	Ref.	€	Q
	99248	57,00	12
	99249	65,00	12
	99250	73,00	12



Produits connexes
Related products



PAG. 2.64

PEANA _ 60559
Base en plastique
Plastic base



PAG. 2.60

LEO _ 60558
Vidage Universel
Universal drain quick-clac



PAG. 1.83

xtreme _ 98655
Accessoires de salle de bain
Bathroom accessories



PAG. 2.61

BIMINI 97106
Robinet d'angle
Angle valve



MITIGEUR BAIN - DOUCHE
Bath-shower mixer

Mitigeur bain-douche, aérateur, inverseur.
Bath-shower mixer, aerator, automatic diverter.

REF.	ACS	Ref.	€	Q
98342 97670 98343		99829	85,00	6+6
Sans kit de douche Without shower kit		99830	75,00	6+6



MITIGEUR DOUCHE
Shower mixer

Mitigeur douche.
Shower mixer.

REF.	ACS	Ref.	€	Q
98342 97670 98343		99831	70,00	6+6
Sans kit de douche Without shower kit		99832	60,00	6+6



MITIGEUR BIDET
Bidet mixer

Mitigeur bidet, aérateur rotule, raccords flexibles M-10 3/8" x 370 mm.
Mixer, swivel aerator, flexible hoses M-10 3/8" x 370 mm.

Cartouche / Cartridge

ec1	Ref.	€	Q
	99826	53,00	12
	99827	61,00	12
	99828	69,00	12

95222 99817 99232



MITIGEUR ÉVIER
Sink mixer

Mitigeur évier bec orientable, aérateur, raccords flexibles M-10 3/8" x 370 mm.
Mixer with aerator, swivel tube spout, flexible hoses M-10 3/8" x 370 mm.

Cartouche / Cartridge

ec1	Ref.	€	Q
	99833	75,00	12

95223 99817 99229

Cartouche / Cartridge

ec3	Ref.	€	Q
	99265	79,00	12

95225 99543 99229

Technologie
Technology



COLD OPEN. SYSTÈME D'OUVERTURE EN EAU FROIDE POUR FAIRE DES ÉCONOMIES D'ÉNERGIE.

*Cold Open system. It opens in cold position.
You save energy.*





With2 antigona



MÉLANGEUR LAVABO 65 Basin mixer 65



Mélangeur lavabo, aérateur, raccords flexibles M-10 3/8" x 370 mm.
Mixer, aerator, flexible hoses M-10 3/8" x 370 mm.

	Ref.	€	☐
	94474	72,00	12
	96545	80,00	12
	97927	88,00	12



MÉLANGEUR LAVABO 3 TROUS 105 Three hole deck basin 105

Mélangeur lavabo 3 trous, aérateur. Flexible 300 mm.
Three-hole basin mixer with aerator. Flexible hoses 300 mm.

	Ref.	€	☐
	98426	184,00	8
	98427	192,00	8
	98428	200,00	8

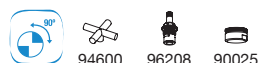

Produits connexes Related products



urban _ 98650
Accessoires de salle de bain
Bathroom accessories

PAG.
1.86



LEO _ 98674
Vidage Universel
Universal drain quick-clac

PAG.
2.60



URBAN _ 90755
Siphon laiton
Brass bottle trap

PAG.
2.61



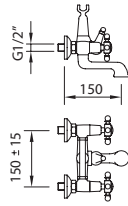

DESIGN _ 40010
Robinet d'angle
Angle Valve

PAG.
2.61



MITIGEUR BAIN - DOUCHE
Bath-shower mixer

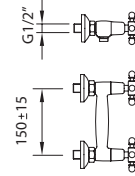

Mélangeur bain-douche, inverseur.
Bath-shower mixer, diverter.

	Ref.	€	
 REF. 90758 97670	94476	126,00	8
Sans kit de douche Without shower kit	 97929	105,00	8



MITIGEUR DOUCHE
Shower mixer





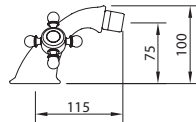

Mitigeur douche.
Shower mixer.

	Ref.	€	
 REF. 90758 97670 96159	94477	81,00	12
Sans kit de douche Without shower kit	 97930	60,00	12



MÉLANGEUR BIDET
Bidet mixer

Mélangeur bidet, aérateur rotule, raccords flexibles
M-10 3/8" x 370 mm.
Mixer, swivel aerator, flexible hoses M-10 3/8" x 370 mm.

	Ref.	€	
 	94475	72,00	12
 	96546	80,00	12
 	97928	88,00	12

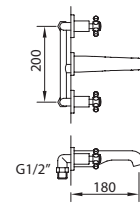

MÉLANGEUR LAVABO MURAL 3 TROUS
Concealed basin mixer

Mélangeur lavabo encastré, aérateur, bec 180 mm.
Concealed mixer 1/2" with aerator, wall spout length 180 mm.

Ref.	€	
98429	151,00	8

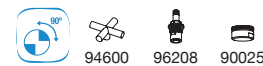

PAG. 1.68

TONGA _ 97113
Support douchette orientable
Articulated holder



PAG. 1.67

ANTIGONA _ 90758
Douchette
Handset



PAG. 1.77

TAMPA _ 96437
Pomme de douche
Shower head

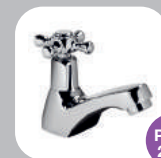

PAG. 2.31

ANTIGONA _ 94489
Robinet simple 40
Single washbasin tap 40

With2 antigona

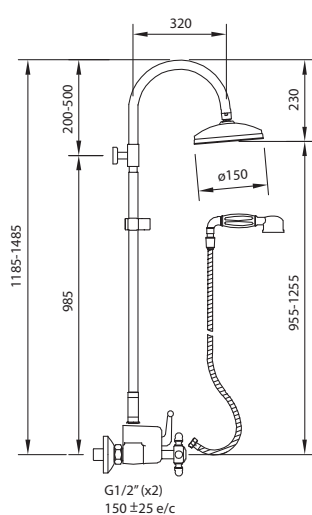
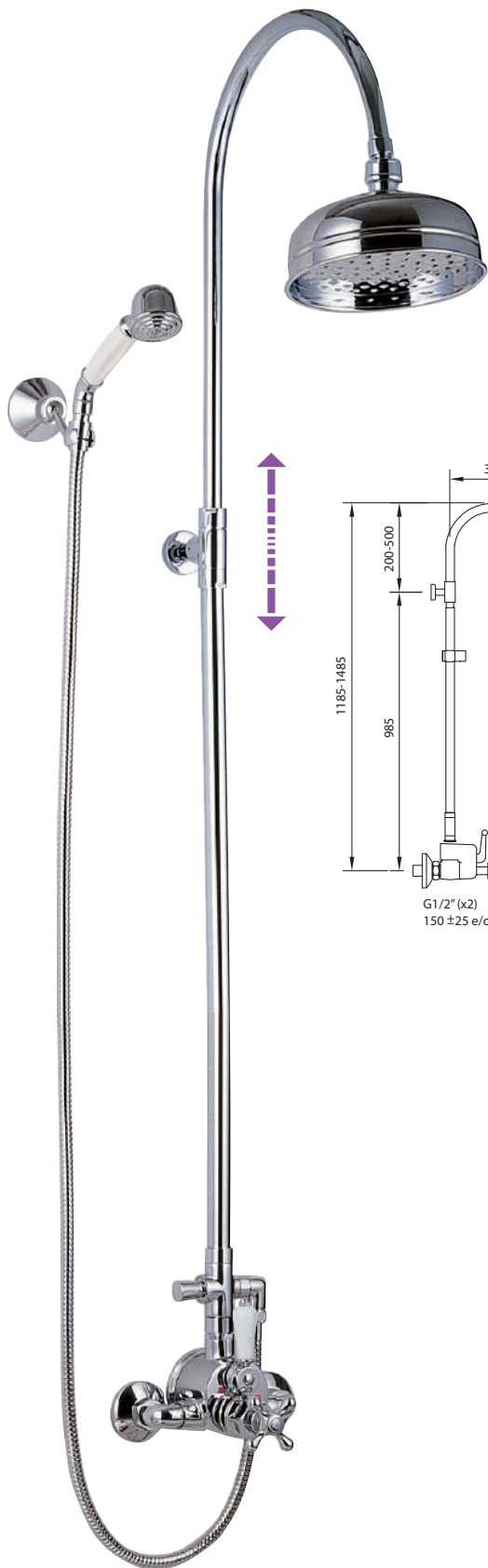

COLONNE DE DOUCHE THERMOSTATIQUE EXTENSIBLE Extensible Thermostatic shower system

Support douchette orientable, inverseur automatique, pomme de douche, douchette et flexible.
Adjustable Thermostatic bath-shower system Cross (96118) with diverter and fixed handset.

Inclus
Includes



New Tampa
96437



Antigona
90758



1,75 m
97670



Antigona
96159



Support
98497



Antao
96120

Ref.	€	
96746	576,00	3



94600 98027



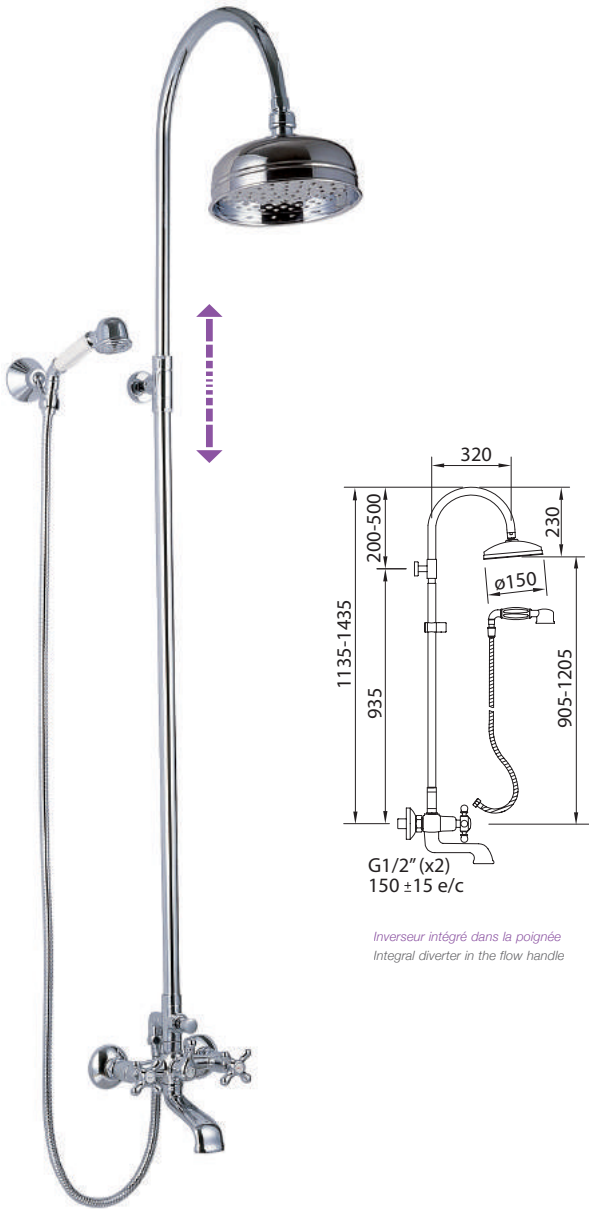

Inverseur intégré dans la poignée
Integral diverter in the flow handle

COLONNE DE BAIN-DOUCHE EXTENSIBLE
Extensible bath-shower system

Support douchette orientable, inverseur manuel/automatique, pomme de douche, douchette et flexible.
Adjustable bath-shower system Cross (96118) with diverter and fixed handset.

Inclus
Includes



Ref.	€	☐
96747	500,00	3

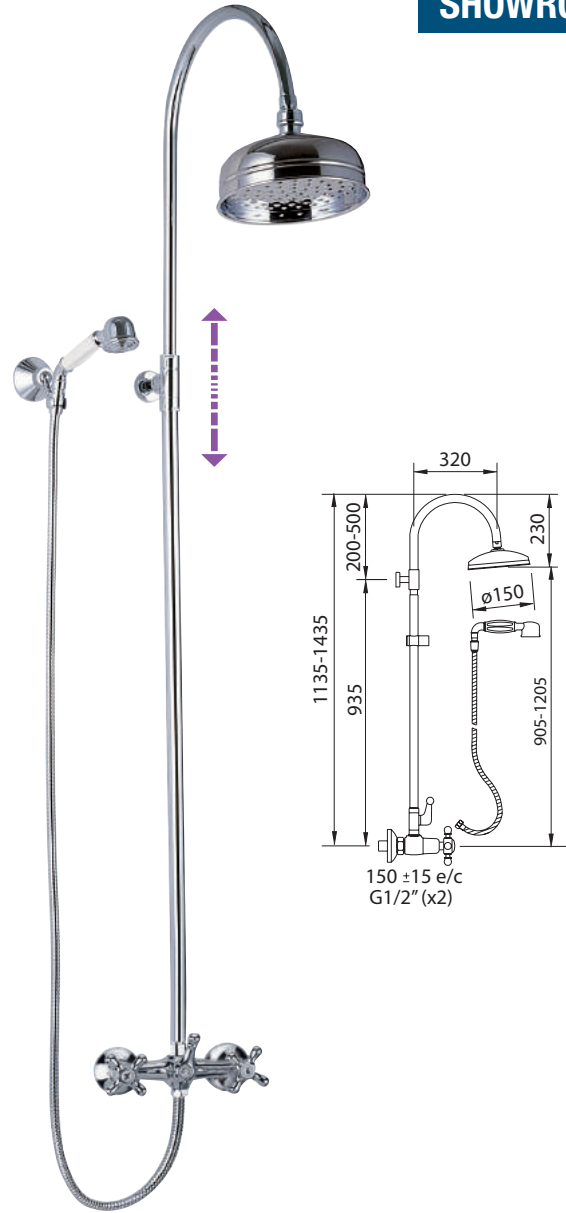

COLONNE DE DOUCHE EXTENSIBLE
Extensible shower system

Support douchette orientable, inverseur manuel, pomme de douche, douchette et flexible.
Adjustable shower system Cross (96118) with diverter and fixed handset.

Inclus
Includes



Ref.	€	☐
96154	455,00	3

Produits connexes
Related products



PAG. 1.68

SILVER HOSE _ 98880
Flexible. Finition argent
Flexible. Silver finish



PAG. 1.67

ANTIGONA _ 90758
Douchette
Handset



PAG. 1.77

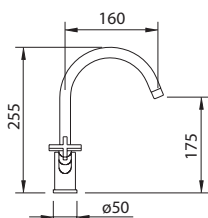

ROUND AIR _ 99604
Pomme de douche
Shower head



MÉLANGEUR LAVABO 175

Basin mixer 175 | Mélangeur lavabo 175

Mélangeur lavabo, aérateur, raccords flexibles M-10 3/8" x 370 mm.
Tall mixer with aerator, flexible hoses M-10 3/8" x 370 mm.

	Ref.	€	📦
	97001	152,00	8
	97881	160,00	8
	97125	168,00	8



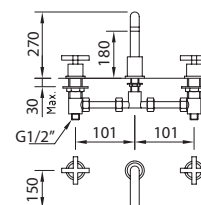

95126 60322



MÉLANGEUR LAVABO 3 TROUS

Three hole deck basin | Mélangeur lavabo 3 trous

Mélangeur lavabo 3 trous, aérateur.
Three-hole basin mixer with aerator spout 180mm.

	Ref.	€	📦
	97006	232,00	6
	97885	240,00	6
	97127	248,00	6



95126 60323

Produits connexes
Related products



PAG. 1.86

urban _ 98650
Accessoires de salle de bain
Bathroom accessories



PAG. 2.60

VELA _ 97395_96255
Vidage métallique
Drain quick-clac metallic



PAG. 2.61

ELEGANCE _ 96174
Siphon laiton
Brass bottle trap



PAG. 2.61

DESIGN _ 40010
Robinet d'angle
Angle Valve



MITIGEUR BAIN-DOUCHE
Bath-shower mixer

Mélangeur bain-douche, aérateur, inverseur.
Bath-shower mixer, aerator, automatic diverter.



REF.
90796
97114
97113

Ref.	€	
97003	243,00	6
97883	222,00	6

Sans kit de douche
Without shower kit



95126



96939



60322



MÉLANGEUR LAVABO À ENCASTRER
Concealed basin mixer

Mélangeur lavabo encastré, aérateur, bec 190 mm.
Concealed basin mixer, spout with aerator.



Ref.

€

97007

232,00

6



95126



60323



MÉLANGEUR BIDET
Bidet mixer

Mélangeur bidet, aérateur rotule, raccords flexibles M-10 3/8" x 370 mm.
Mixer, swivel aerator, flexible hoses M-10 3/8" x 370 mm.



Ref.

€

97002

152,00

8



97882

160,00

8



97126

168,00

8



95126



60322



MITIGEUR ÉVIER
Sink mixer

Mélangeur évier, bec orientable e aérateur, raccords flexibles M-10 3/8" x 370 mm.
Mixer with aerator, swivel tube spout, flexible hoses M-10 3/8" x 370 mm.



Ref.

€

97005

152,00

8



95126



97688



60322



PAG. 1.70



PAG. 1.68

SILVER HOSE _ 98880
Flexible. Finition argent
Flexible. Silver finish



PAG. 1.78

BEAM _ 60303
Pomme de douche
Shower head



PAG. 1.66

BEAM _ 60304
Douchette
Handset



STYLE 99627
Kit douche
Shower kit

With2 morea

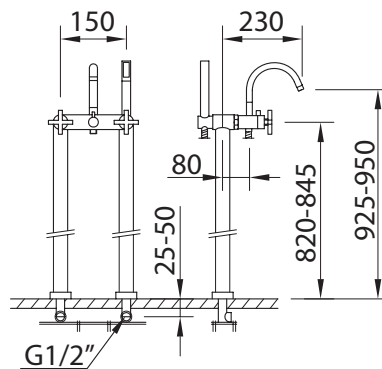

MÉLANGEUR BAIN-DOUCHE SUR COLONNES AVEC PRISE D'EAU AU SOL

Floor standing bath-shower mixer

Mélangeur bain-douche sur colonne avec prise d'eau au sol, aérateur, inverseur automatique.
Floor standing bath-shower mixer, aerator, diverter.

Inclus
Includes



Caiman
90796



1,80 m
97114

Ref.	€	📦
97020	702,00	6



95126



60322



97001
Mélangeur lavabo
Basin mixer



Thermostatique *elegance*

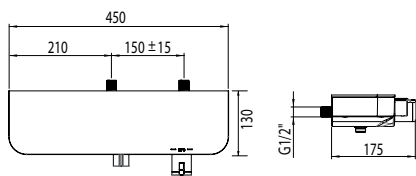

NINE *elegance* MITIGEUR DOUCHE THERMOSTATIQUE *Thermostatic shower mixer*

Inclus
Includes



Style Air
100x120
99611



Silver Hose
1,75 m
98880



Start
60311



MAX. 42

MAX. 32

Montage des raccords
excentrés
Eccentric nut assembling



Sans kit de douche
Without shower kit

Ref.	€	📦
60154	383,00	4
60761	352,00	4



Produits connexes
Related products



PAG.
1.68

SILVER HOSE _ 98880
Flexible. Finition argent
Flexible. Silver finish



PAG.
1.66

STYLE_99610
Douchette
Handset



PAG.
1.76

SLIM INOX AIR_99600
Pomme de douche 200x200
Shower head

Thermostatiques xtreme

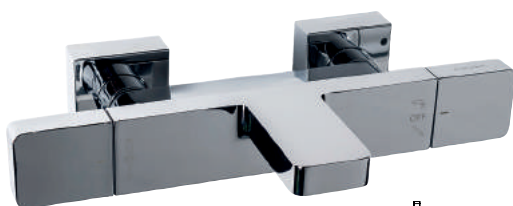

Inverseur intégré dans la poignée
Diverter built in the flow handle

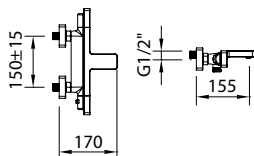

NINE xtreme MITIGEUR BAIN-DOUCHE THERMOSTATIQUE

Thermostatic bath-shower mixer

Mitigeur bain-douche thermostatique, aérateur et inverseur.
Bath-shower mixer, aerator and diverter built in.

Inclus
Includes



Ref.	€	☐
60131	342,00	6
60132	311,00	6

Sans kit de douche
Without shower kit



99652 98776 98775

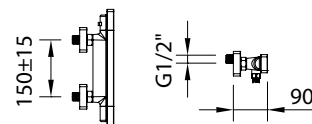
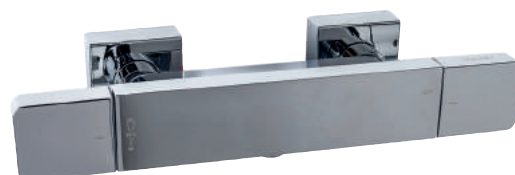

NINE xtreme MITIGEUR DOUCHE THERMOSTATIQUE

Thermostatic shower mixer

Mitigeur douche thermostatique.
Shower mixer.

Inclus
Includes



Ref.	€	☐
60133	290,00	6
60134	259,00	6

Sans kit de douche
Without shower kit



99652

Produits connexes
Related products



PAG.
1.68

SILVER HOSE _ 98880
Flexible. Finition argent
Flexible. Silver finish



PAG.
1.67

MARINA_ 96786
Douchette
Handset



PAG.
1.76

SLIM INOX AIR_ 99600
Pomme de douche 200x200
Shower head

Thermostatiques urban



 **Système COLD TOUCH**
Robinetterie anti-brûlures

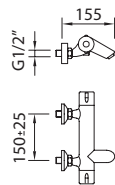

Inverseur intégré dans la poignée
Diverter built in the flow handle

NINE urban MITIGEUR BAIN-DOUCHE THERMOSTATIQUE Thermostatic bath-shower mixer

Mitigeur bain-douche thermostatique, aérateur, inverseur céramique intégré, corps froid.
Thermostatic bath-shower mixer, cold touch.

REF.	Ref.	€	📦
96108 97670 98208	98823	218,00	6
Sans kit de douche Without shower set	98929	203,00	6



 **Système COLD TOUCH**
Robinetterie anti-brûlures

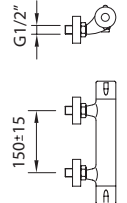

NINE urban MITIGEUR DOUCHE THERMOSTATIQUE Thermostatic shower mixer

Mitigeur douche thermostatique, aérateur, corps froid.
Thermostatic shower mixer, cold touch.

REF.	Ref.	€	📦
96108 97670 98208	98478	184,00	6
Sans kit de douche Without shower set	98149	169,00	6



SYSTÈME COLD TOUCH ANTI-BRÛLURES.

Évite que les corps de nos douches et bains douches ne chauffent et ne brûlent.
Idéal pour la sécurité des enfants.

Cold touch system. Maintain the body cold. Ideal for the child security.

STANDARD

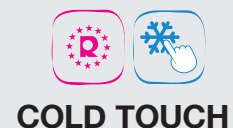
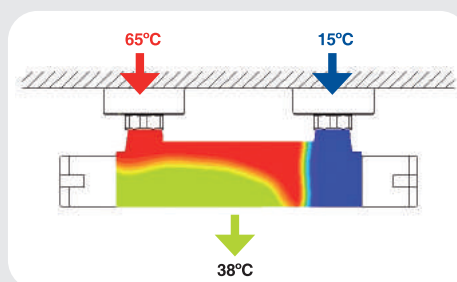

COLD TOUCH

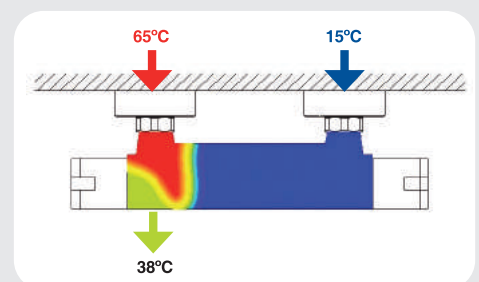



Inverseur intégré dans la poignée
Diverter built in the flow handle

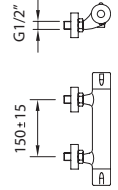
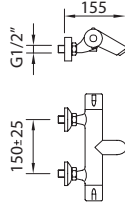

NINE urban
MITIGEUR BAIN-DOUCHE THERMOSTATIQUE
Thermostatic bath-shower mixer

Mitigeur bain-douche thermostatique, aérateur, inverseur céramique intégré.
Thermostatic bath-shower mixer.

REF.	Ref.	€	📦
96108 97670 90011	98822	203,00	6
Sans kit de douche Without shower set			
	98928	188,00	6



NINE urban
MITIGEUR DOUCHE THERMOSTATIQUE
Thermostatic shower mixer

Mezclador termostático para ducha.
Thermostatic shower mixer.
Mitigeur douche thermostatique

REF.	Ref.	€	📦
96108 97670 90011	60325	169,00	-
Sans kit de douche Without shower set			
	60326	154,00	-

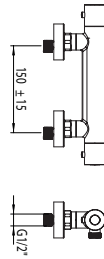

NINE SLIM urban
MITIGEUR DOUCHE THERMOSTATIQUE
Thermostatic shower mixer

Mitigeur douche thermostatique, aérateur.
Thermostatic shower mixer.

REF.	Ref.	€	📦
98342 97670 98343	ACS 60414	158,00	6
Sans kit de douche Without shower set			
	ACS 60415	143,00	6



Produits connexes
Related products



urban_99459
Accessoires de salle de bain
Bathroom accessories



SILVER HOSE_98880
Flexible. Finition argent
Flexible. Silver finish



STYLE_99613
Douchette
Handset



STYLE_99621
Barre de douche
Sliding bar

Combi Thermostatique *elegance*

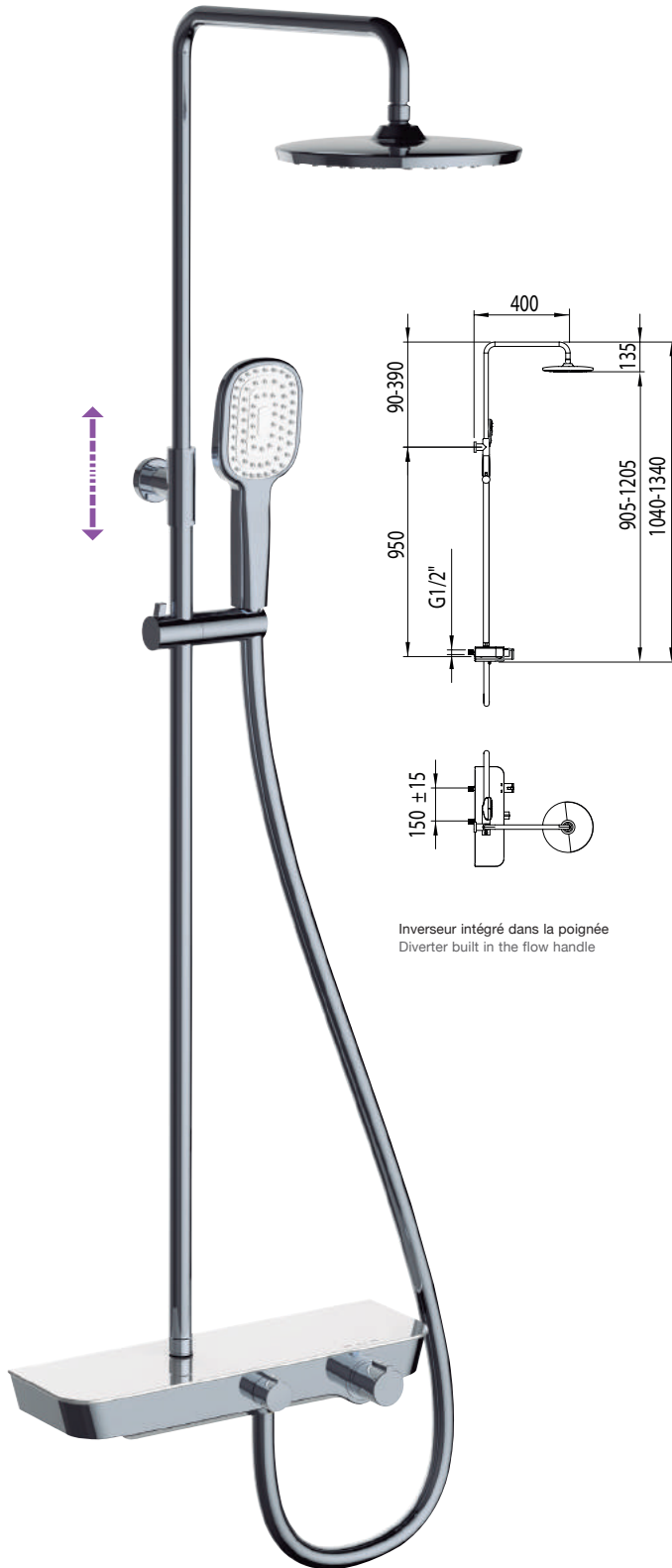

Inverseur intégré dans la poignée
Diverter built in the flow handle

NINE *elegance*

COLONNE DE DOUCHE THERMOSTATIQUE EXTENSIBLE *Thermostatic Extensible shower system*

Support douchette coulissant, inverseur céramique, pomme de douche, douchette et flexible.
Adjustable thermostatic shower system (98517) with diverter built in.

Inclus
Includes



Style Air
240x190
99606



Style Air
100x120
99611



Silver Hose
1,75 m
98880



Ceilan
96264

Ref.	€	Q
99731	595,00	4

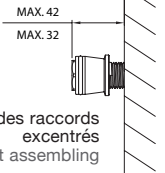

Montage des raccords
excentrés
Eccentric nut assembling

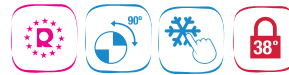

Flexibles 1,75 m
Flexibles

Finition argent.
Anti torsion.
Nettoyage facile.

Silver finished. Anti twist. Easy cleaning.

Contrôle de la température
Temperature control

Arrêt de sécurité pour températures supérieures à **38°C**
Évite les brûlures.

*Safety stop for temperatures higher than 38°C.
Avoid burns.*

Contrôle de sortie d'eau
Water outlet control

Douchette | Pomme de douche
Handset - Shower head

Plate-forme blanc élégant

Elegant white tray | Plate-forme blanc élégant

Permet à l'utilisateur de déposer ses articles de douche sans nécessité d'installer un plateau supplémentaire.

Allows the end user to leave the shampoos without installing any additional shelf.

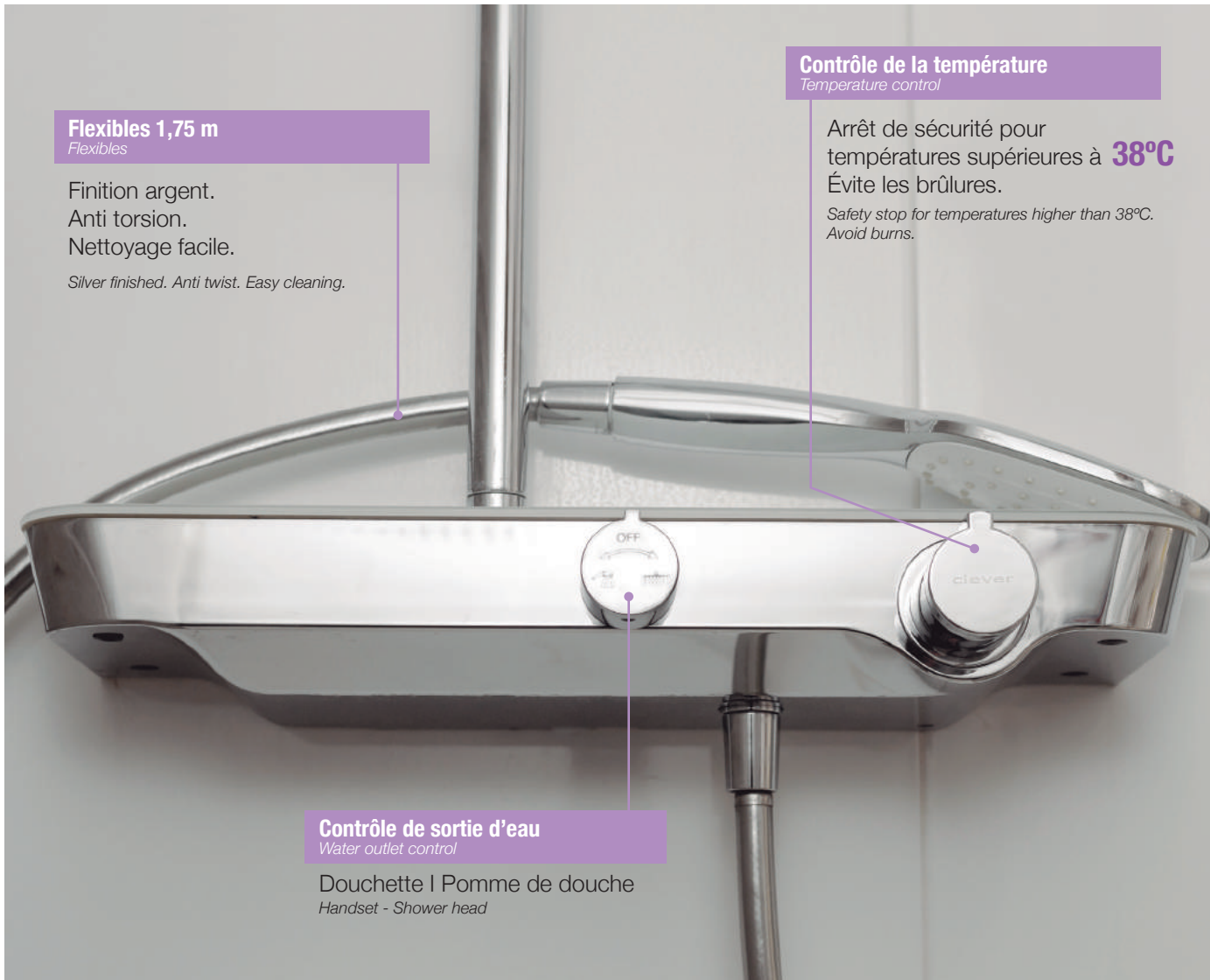

Combi Thermostatique xtreme

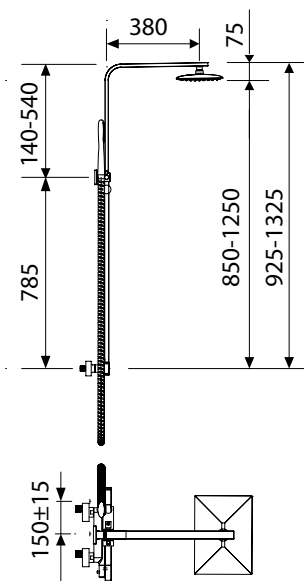
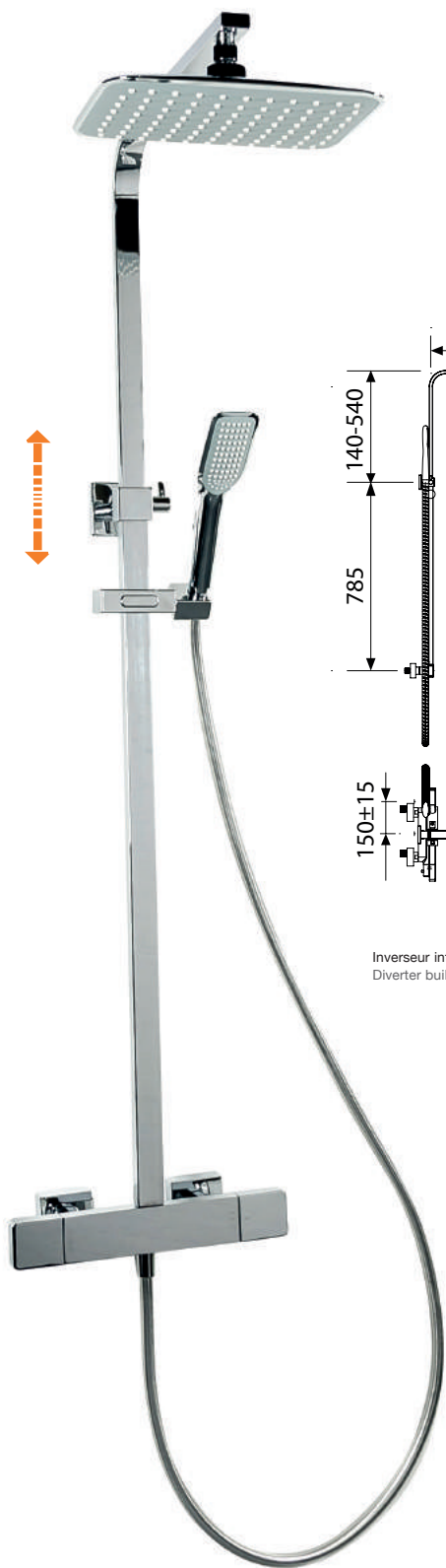

Inverseur intégré dans la poignée
Diverter built in the flow handle

NINE xtreme COLONNE DE DOUCHE THERMOSTATIQUE EXTENSIBLE Thermostatic Extensible shower system

Inclus
Includes



260x190
99608



99609



Silver hose
1,75 m
98880

Ref.	€	
60135	512,00	4



98027

60139



Contrôle de la température
Temperature control

Arrêt de sécurité pour températures supérieures à **38°C**
Évite les brûlures.
Safety stop for temperatures higher than 38°C.
Avoid burns.



Contrôle de sortie d'eau
Water outlet control

Douchette | Pomme de douche pour Colonne de douche extensible thermostatique
Handset - Shower head for Thermostatic extensible shower system

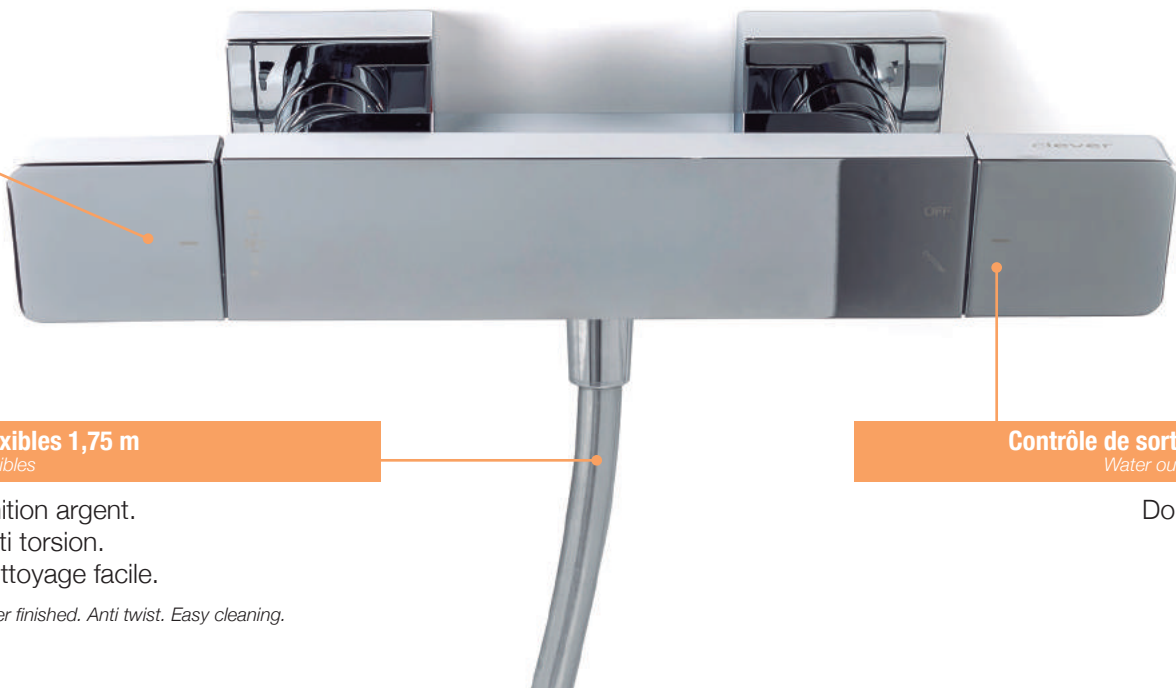
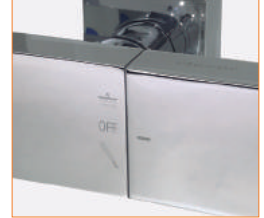

Flexibles 1,75 m
Flexibles

Finition argent.
Anti torsion.
Nettoyage facile.
Silver finished. Anti twist. Easy cleaning.

Contrôle de sortie d'eau
Water outlet control

Douchette
Handset



Support coulissant
Sliding support

Combi Thermostatique urban

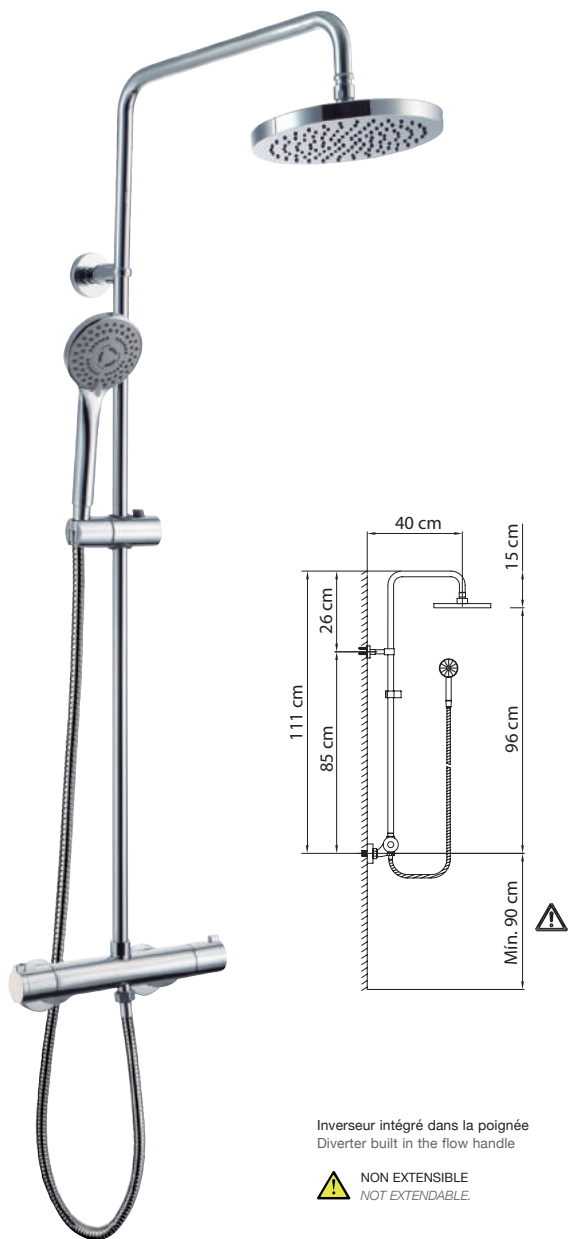

NINE urban COLONNE DE DOUCHE THERMSTATIQUE Thermostatic shower system

Support douchette coulissant, inverseur céramique, pomme de douche, douchette et flexible.
Thermostatic shower valve with diverter built in.

Inclus
Includes



Ref.	€	
60328	400,00	1

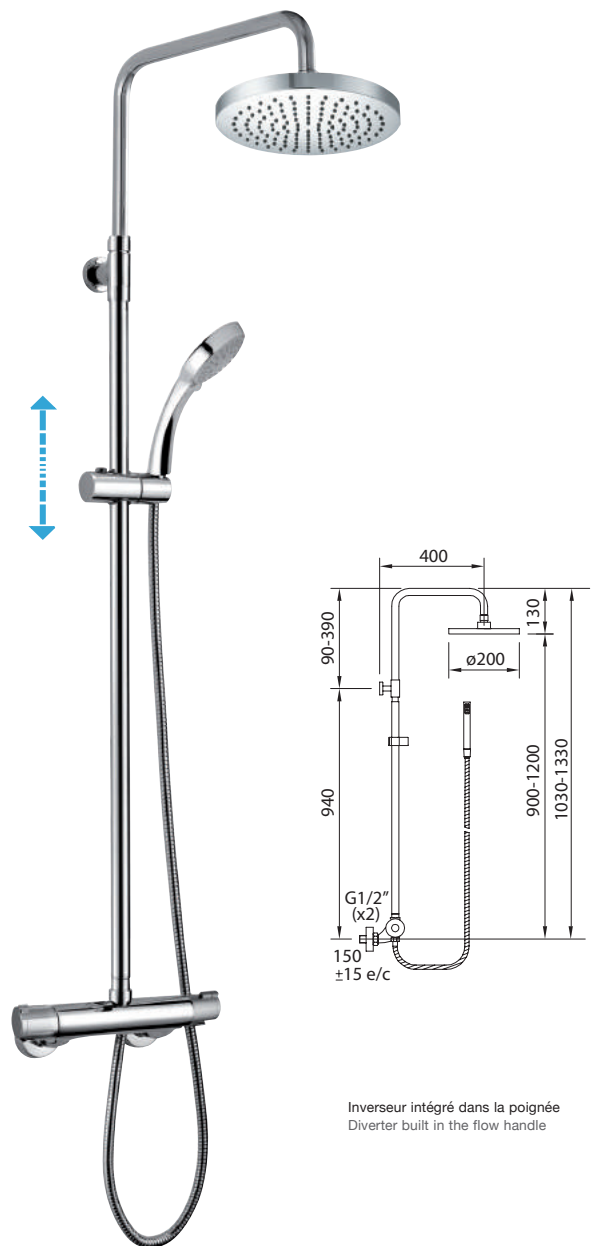

NINE urban COLONNE DE DOUCHE THERMSTATIQUE EXTENSIBLE Extensible Thermostatic shower system

Support douchette coulissant, inverseur céramique, pomme de douche, douchette et flexible.
Adjustable thermostatic shower system (98517) with diverter built.

Inclus
Includes



Ref.	€	
60327	431,00	-



Combi Thermostatique retro

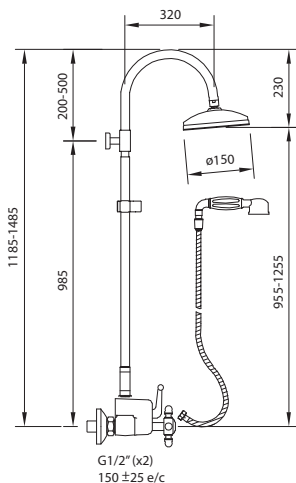
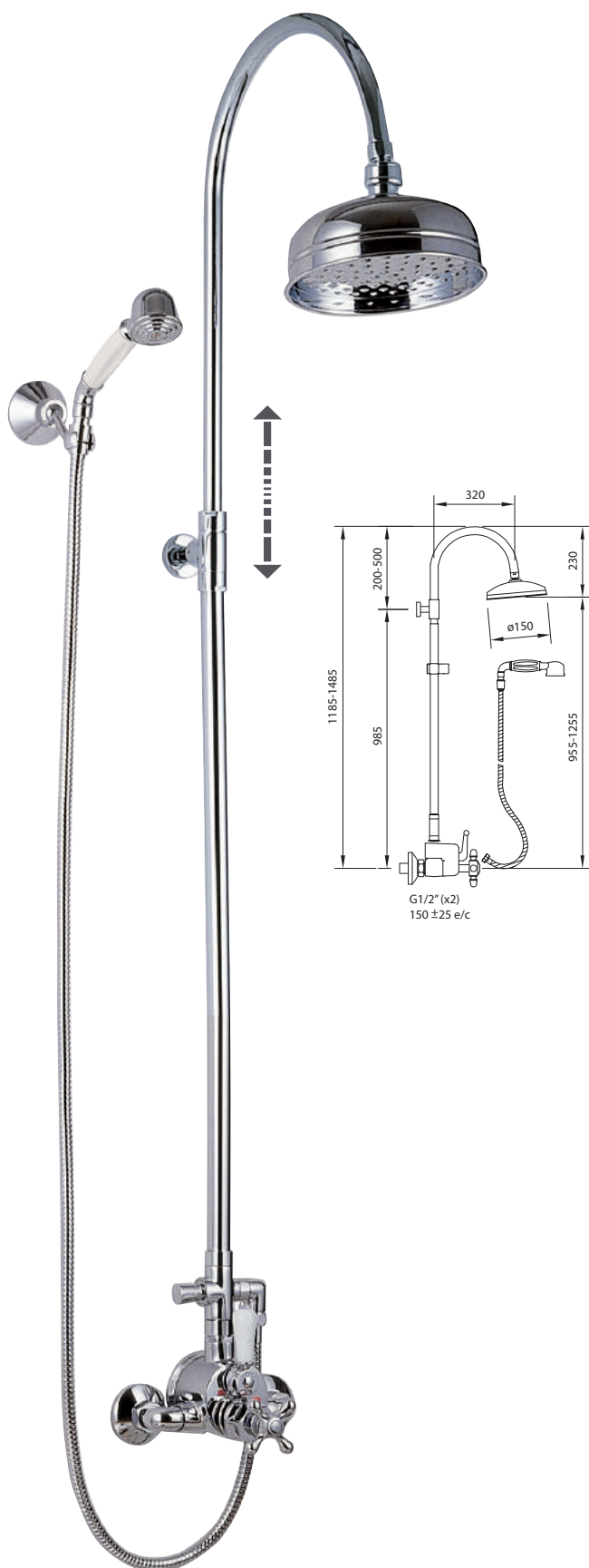

WITH2 *antigona* COLONNE DE DOUCHE THERMOSTATIQUE EXTENSIBLE *Extensible Thermostatic shower system*

*Support douchette orientable, inverseur automatique, pomme de douche, douchette et flexible.
Adjustable Thermostatic bath-shower system Cross (96118) with diverter and fixed handset.*

Inclus Includes



New Tampa
96437



Antigona
90758



1,75 m
97670



Antigona
96159



Support
96497



Antao
96120

Ref.	€	☐
96746	576,00	3



94600 98027



Combis Douche

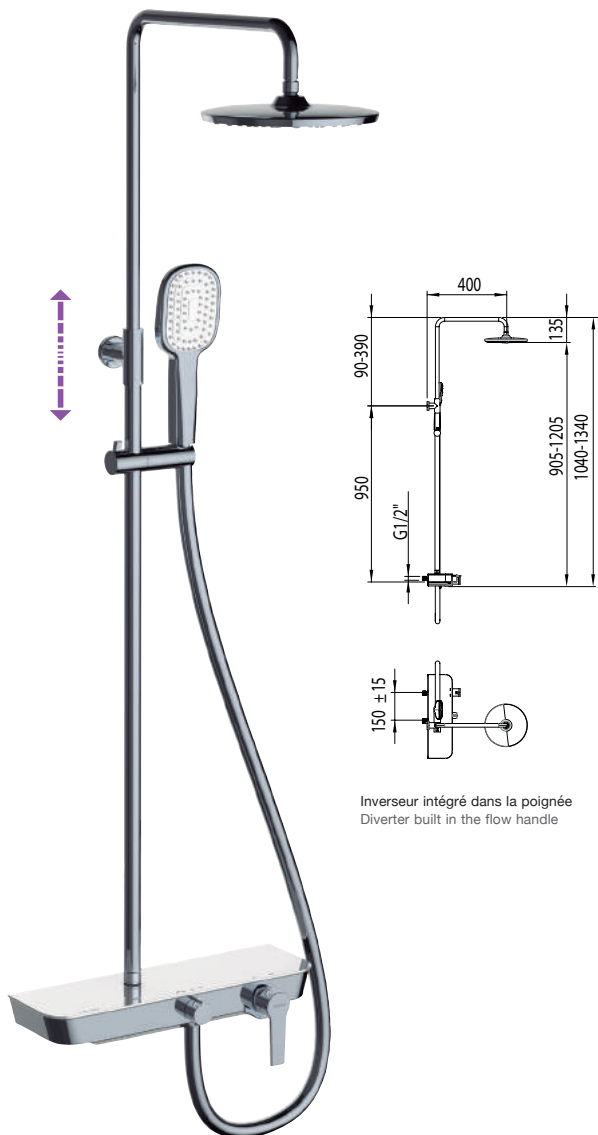

Inverseur intégré dans la poignée
Diverter built in the flow handle

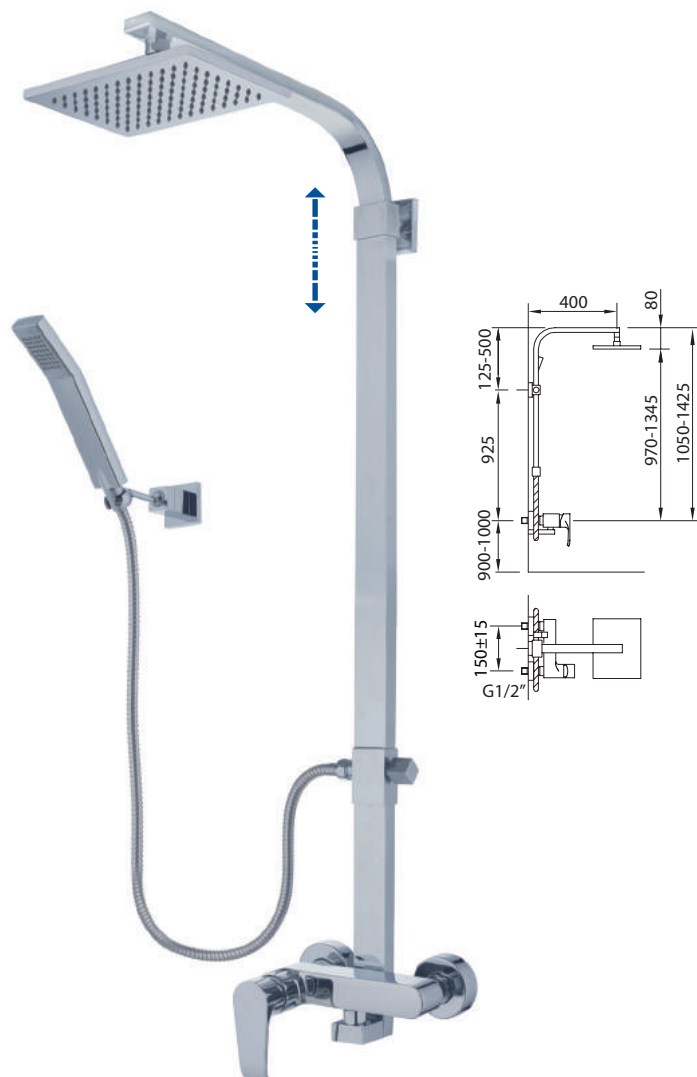

NINE *elegance* COLONNE DE DOUCHE EXTENSIBLE Extensible shower system

Support douchette coulissant, inverseur automatique, pomme de douche, douchette et flexible.
Adjustable shower valve with diverter built in.

Inclus
Includes



Ref.	€	Q
99732	518,00	4

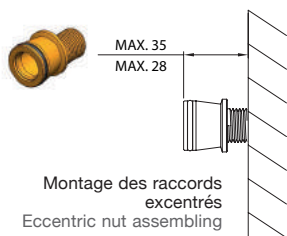

Montage des raccords
excentrés
Eccentric nut assembling



PAULA COLONNE DE DOUCHE EXTENSIBLE Shower system

Support douchette orientable, inverseur automatique, pomme de douche, douchette et flexible.
Adjustable shower system.

Inclus
Includes



Ref.	€	Q
98415	725,00	4



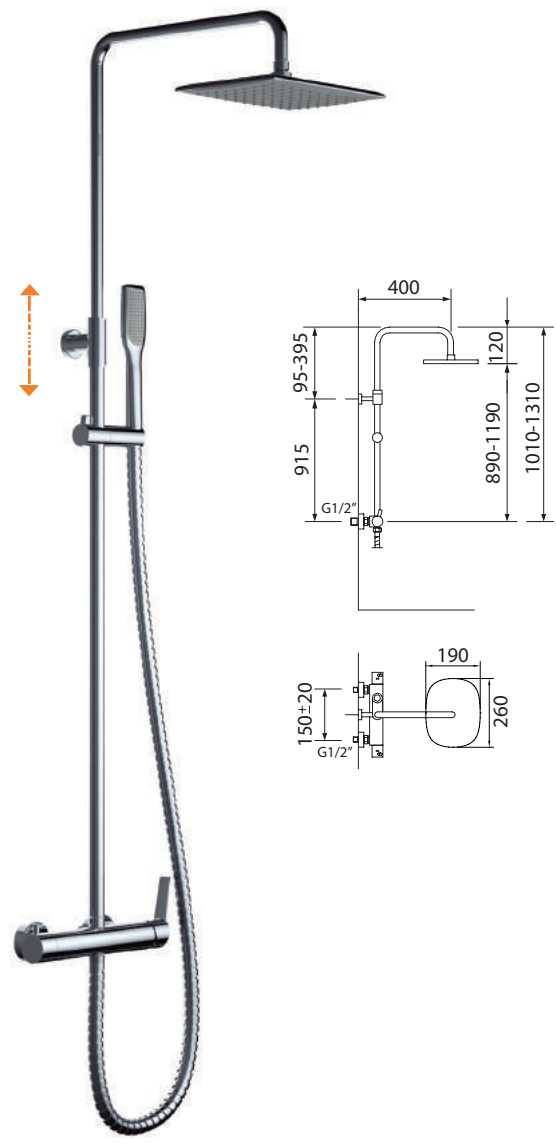
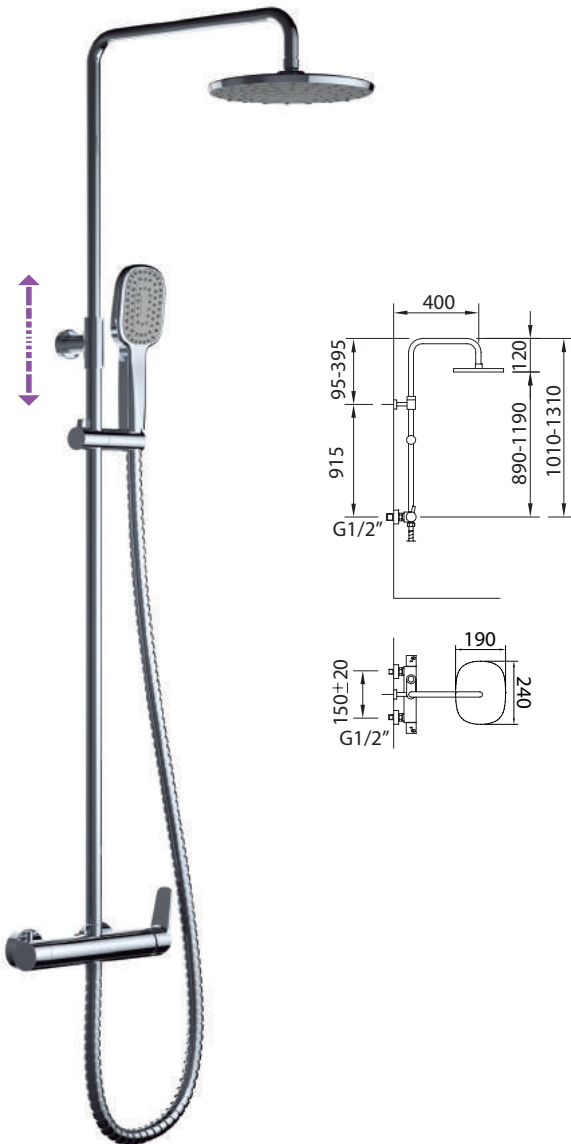

START *elegance*
COLONNE DE DOUCHE EXTENSIBLE
Extensible shower system

Support douchette coulissant, pomme de douche, douchette et flexible.
 Adjustable shower system with diverter built in.

Inclus
 Includes



Ref.	€	📦
99646	373,00	-



START *xtreme*
COLONNE DE DOUCHE EXTENSIBLE
Extensible shower system

Support douchette coulissant, pomme de douche, douchette et flexible.
 Adjustable shower system with diverter built in.

Inclus
 Includes



Ref.	€	📦
99727	373,00	-

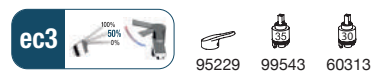

Combis Douche

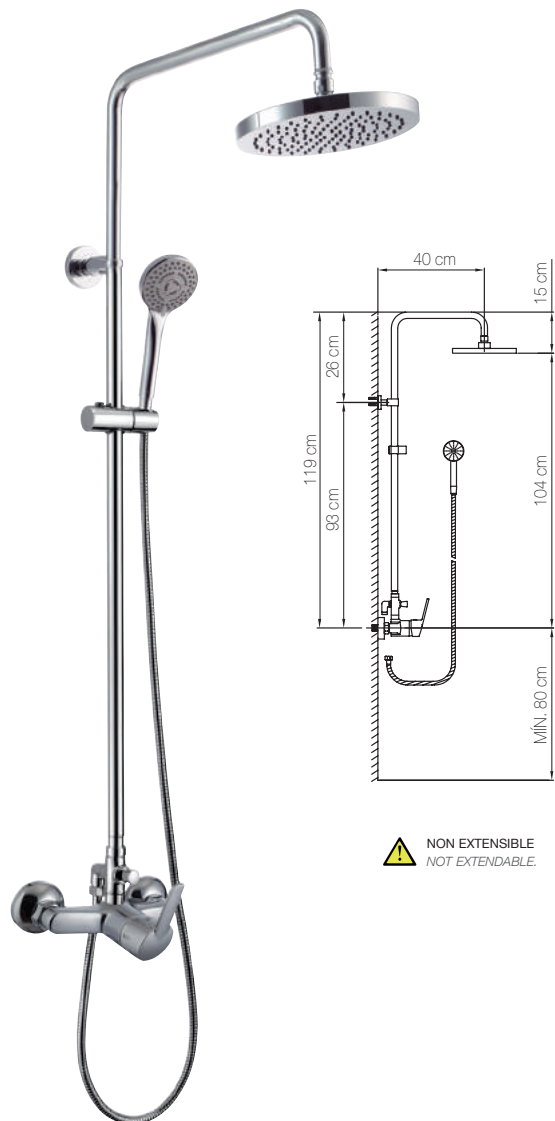
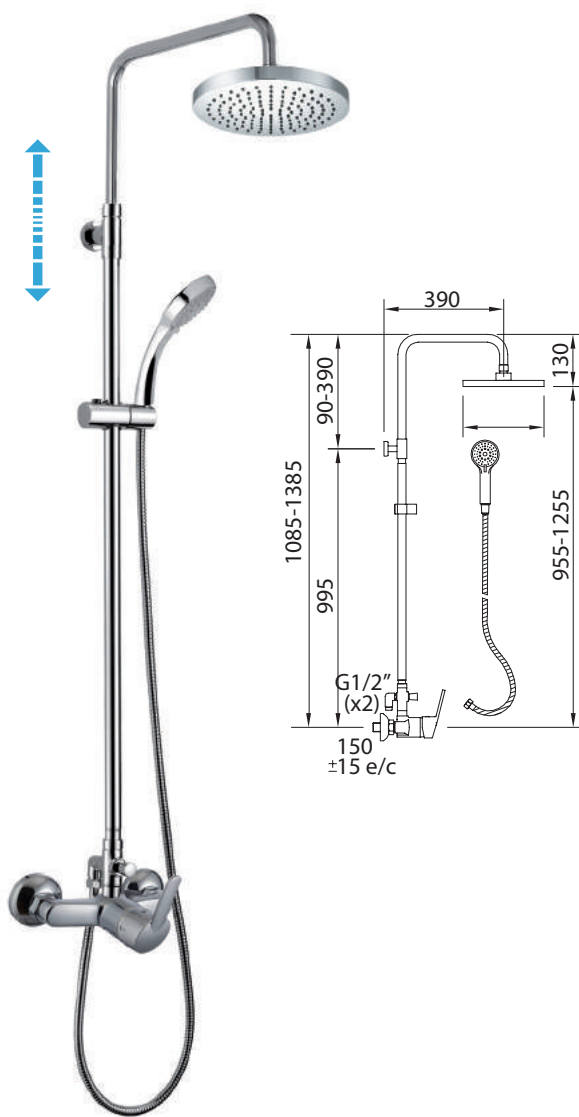

S12 **urban** COLONNE DE DOUCHE EXTENSIBLE *Adjustable shower system*

Support douchette coulissant, inverseur automatique, pomme de douche, douchette et flexible.
Adjustable shower valve with automatic diverter.

Inclus
Includes



Ref.	€	
98909	340,00	1



S12 **urban** COLONNE DE DOUCHE *Shower system*

Ensemble de douche, pomme de douche, douchette et flexible.
Adjustable shower valve with automatic diverter.

Inclus
Includes



Ref.	€	
99308	309,00	1



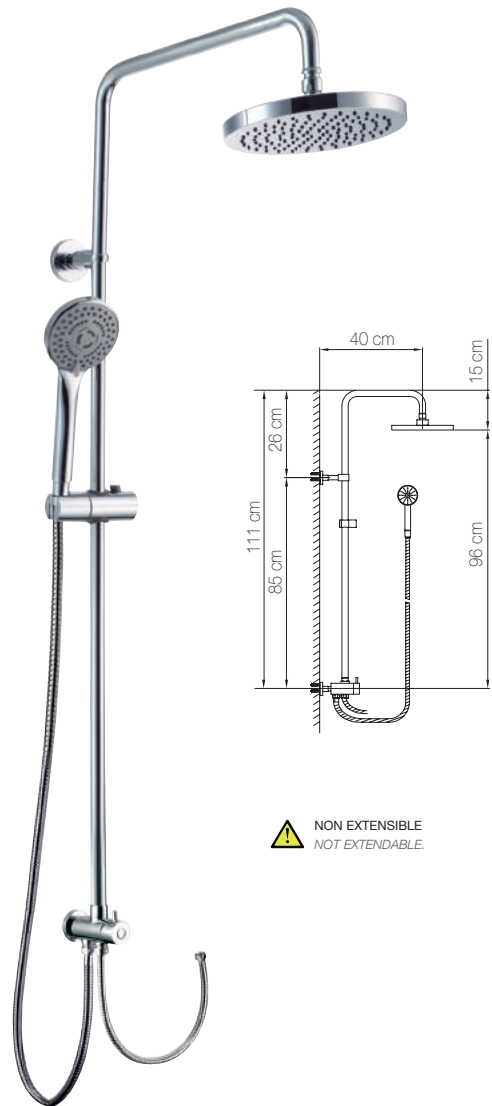

 NON EXTENSIBLE
NOT EXTENDABLE.

WITH2 antigona
COLONNE DE DOUCHE EXTENSIBLE
Extensible shower system

Support douchette orientable, inverseur manuel, pomme de douche, douchette et flexible.
Adjustable shower system Cross (96118) with diverter and fixed handset.

Inclus
Includes



Ref.	€	📦
96154	455,00	3



KIT BOX
COLONNE DE DOUCHE
Shower bar set

Inclus
Includes



Ref.	€	📦
99623	224,00	1



Douchettes *Handsets*

Tech **AIR**

Technologie AIR
AIR Technology



Les douchettes Clever

sont équipées de la technologie AIR Advanced la plus avancée. L'injection d'air avant la sortie d'eau permet de donner du volume aux gouttes et d'obtenir une sensation plus douce et confortable sous la douche. Elle permet aussi d'économiser jusqu'à **30%** de consommation d'eau et d'énergie.

Clever handsets use the advanced technology AIR Advanced. Mixing air with the incoming water reduces the water consumption at least 30%.



-30%
Water reduce

5
Fonctions
Funtions

ABS

Douchette 5 positions, ABS chromé.
Multi-function rub clean handset. Chromed ABS



HEXAGON AIR | 5F | Ø100 mm
DOUCHETTE | Handset

Ref.	€	📦
60307	18,00	-



TANGANYKA | 5F | Ø100 mm
DOUCHETTE | Handset

Ref.	€	📦
ACS 97994	27,00	-



ISÈRE | 5F | Ø100 mm
DOUCHETTE | Handset

Ref.	€	📦
ACS 97984	25,00	-



5
Funciones
Fonctions

Tanganika

Cod. 97994 (Voir la page / See page 64)



 **Mousseur**
Foam



 **Pluie**
Rain



 **Massage**
Massage



 **Brume**
Fog



 **Spray**
Spray

3
Funciones
Fonctions

Beam

Cod. 60304 (Voir la page / See page 66)



 **Pluie**
Rain



 **Massage**
Massage

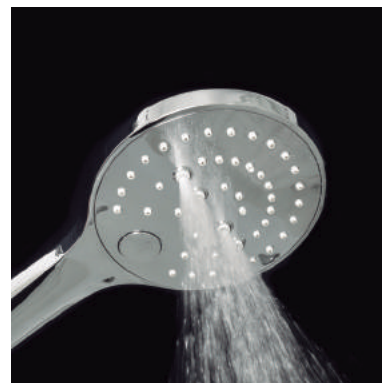

 **Spray**
Spray

Douchettes *Handsets*

3 Fonctions
Functions

ABS

Douchette 3 positions, ABS chromé.
Multi-function rub clean handset. Chromed ABS



BEAM

Avec sortie d'eau à haute pression vaporisée.
High pressure outlet with spray water sensation.

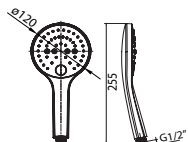

BEAM | 3F | Ø120 mm
DOUCHETTE | Handset

Ref.	€	📦
BEAM 60304	29,00	-

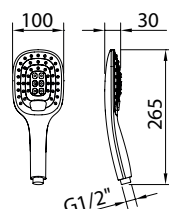

STYLE | 3F | 100x120 mm
DOUCHETTE | Handset

Ref.	€	📦
99610	31,00	48

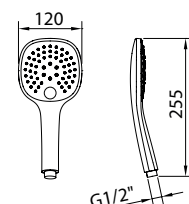

STYLE | 3F | 120x120 mm
DOUCHETTE | Handset

Ref.	€	📦
99613	27,00	60

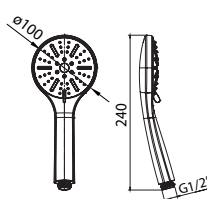
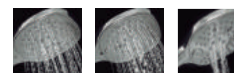

SYVARI EVO AIR | 3F | Ø100 mm
DOUCHETTE | Handset

Ref.	€	📦
60302	18,00	-

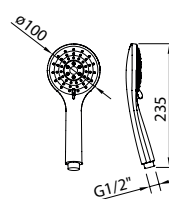
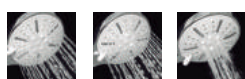

CITY AIR | 3F | Ø100 mm
DOUCHETTE | Handset

Ref.	€	📦
99615	17,00	60

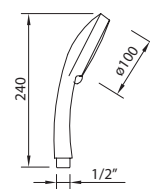
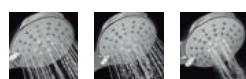

SYVARI | 3F | Ø100 mm
DOUCHETTE | Handset

Ref.	€	📦
ACS 98884	18,00	1

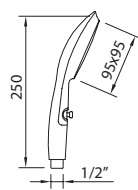
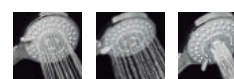

SYSMA | 3F | Ø90 mm
DOUCHETTE | Handset

Ref.	€	📦
98888	26,00	1

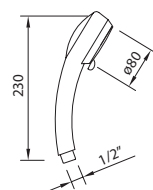
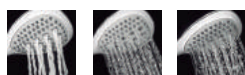

VIENNE | 3F | Ø80 mm
DOUCHETTE | Handset

Ref.	€	📦
ACS 97983	21,00	8



1 ABS

Fonction
Function

Douchette 1 position, ABS chromé.
Single-function rub clean handset. Chromed ABS



STYLE AIR | 1F | 100x120 mm
DOUCHETTE | Handset

Ref.	€	📦
99611	18,00	60



STYLE AIR | 1F | 120x120 mm
DOUCHETTE | Handset

Ref.	€	📦
99612	24,00	60



TREND | 1F | 55x100 mm
DOUCHETTE | Handset

Ref.	€	📦
99609	16,00	100



CITY AIR | 1F | Ø100 mm
DOUCHETTE | Handset

Ref.	€	📦
99614	16,00	60

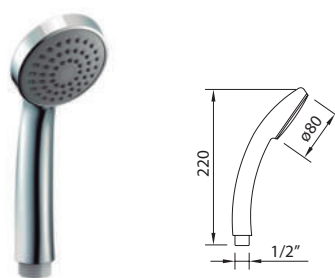

NF | 1F | Ø80 mm
DOUCHETTE | Handset

Ref.	€	📦
99129	14,00	1



NANKAI | 1F | Ø90 mm
DOUCHETTE | Handset

Ref.	€	📦
97142	16,00	50

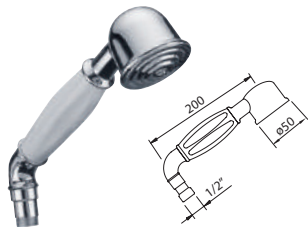

ANTIGONA | 1F | Ø50 mm
DOUCHETTE | Handset

Ref.	€	📦
90758	19,00	50



Laiton / Brass

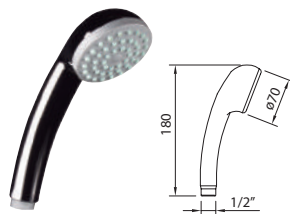

S12 | 1F | Ø70 mm
DOUCHETTE | Handset

Ref.	€	📦
98342	7,90	1

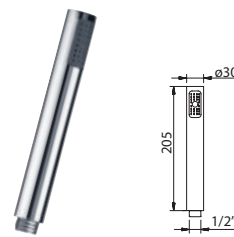

CAIMAN | 1F
DOUCHETTE | Handset

Ref.	€	📦
90796	13,00	50

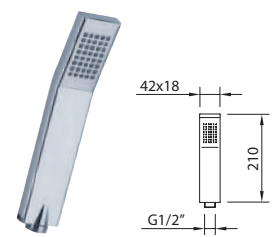

MARINA | 1F
DOUCHETTE | Handset

Ref.	€	📦
96786	22,00	50



Supports *Wall brackets*

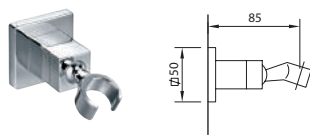

PASCUA
SUPPORT DOUCHETTE
ORIENTABLE

Articulated holder

Laiton chromé. / Chromed brass.

Ref.	€	📦
97112	28,00	20

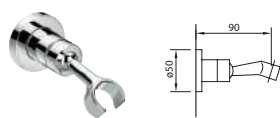

TONGA
SUPPORT DOUCHETTE
ORIENTABLE

Articulated holder

Laiton chromé. / Chromed brass.

Ref.	€	📦
97113	19,00	20



LUZON
SUPPORT DOUCHETTE
ORIENTABLE

Articulated holder

ABS chromé. / Chromed ABS.

Ref.	€	📦
96458	12,00	20



MOA
SUPPORT DOUCHETTE
ORIENTABLE

Articulated holder

ABS chromé. / Chromed ABS.

Ref.	€	📦
96942	8,50	50

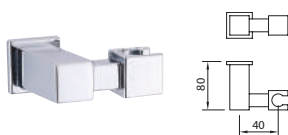

SAONA
SUPPORT DOUCHETTE
ORIENTABLE

Articulated holder

ABS chromé. / Chromed ABS.

Ref.	€	📦
96413	8,00	20

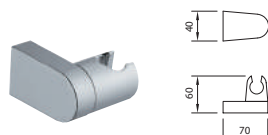

HABANA XTREME
SUPPORT DOUCHETTE
ORIENTABLE

Articulated holder

ABS chromé. / Chromed ABS.

Ref.	€	📦
98208	5,50	20

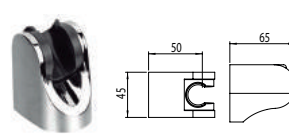

START
SUPPORT DOUCHETTE
ORIENTABLE

Articulated holder

ABS chromé. / Chromed ABS.

Ref.	€	📦
60311	5,50	-

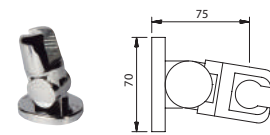

HABANA
SUPPORT DOUCHETTE
ORIENTABLE

Articulated holder

ABS chromé. / Chromed ABS.

Ref.	€	📦
90011	4,35	20

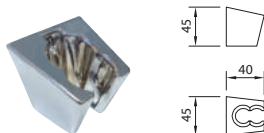

S12
SUPPORT DOUCHETTE
FIXE / Fix holder

ABS chromé, 2 positions.
Chromed ABS, 2 positions.

Ref.	€	📦
98343	3,31	24

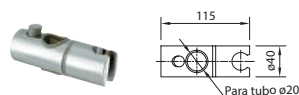

BASIC BOX
SUPPORT COULISSANT
ARTICULÉ

Articulated holder

Ref.	€	📦
BASIC BOX Pour tube ø20. 98997	15,00	20
CEILAN Pour tube ø25. 96264	21,00	20

Flexibles *Flexibles*

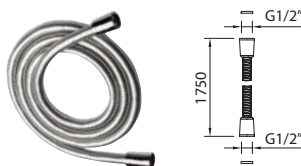

SILVER HOSE
1,75m
FLEXIBLE | Flexible

PVC. Finition argent
PVC. Silver finish.

Ref.	€	📦
98880	23,00	1
ACS 98022	36,00	1

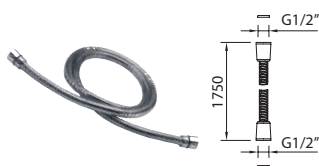

FLEXIBLE | Flexible
1,75m

Ecrous coniques. Laiton.
Flexible 1/2" for handshower with 2
conical nuts. Brass.

Ref.	€	📦
96122	15,00	100



FLEXIBLE | Flexible

97816: L=1,20 m Inox, stainless steel
90703: L=1,50 m Inox, stainless steel
90704: L=1,75 m Inox, stainless steel

Ref.	€	📦
ACS 97816	6,50	15
90703	7,00	50
90704	9,00	40

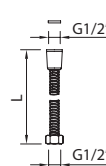

97670: L=1,75 m Inox, stainless steel
97114 cromado: L=1,80 m Inox, stainless steel
99128: L=1,75 m Inox, stainless steel

Ref.	€	📦
ACS 97670	9,50	50
97114	16,00	50
ACS NF 99128	10,00	50



96458
LUZON
Support
Wall bracket



96413
SAONA
Support
Wall bracket



98997
BASIC BOX
Support
Wall bracket



98880
SILVER HOSE
Flexible
Flexible

Barres de douche *Shower kits*

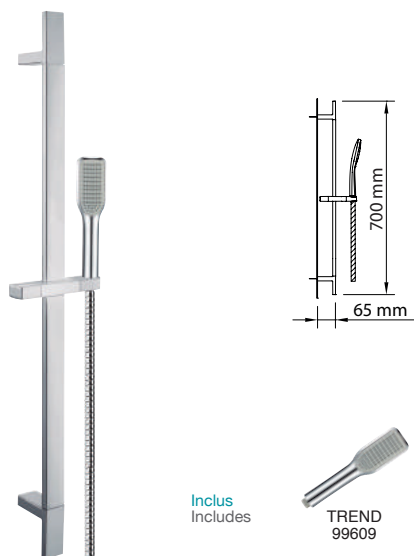

Inclus
Includes



TREND
99609

1,75 m
97670

TREND - 30x10x700 mm
ENSEMBLE BARRE DE DOUCHE
Sliding bar set
ABS

Ref.	€	📦
99626	88,00	10

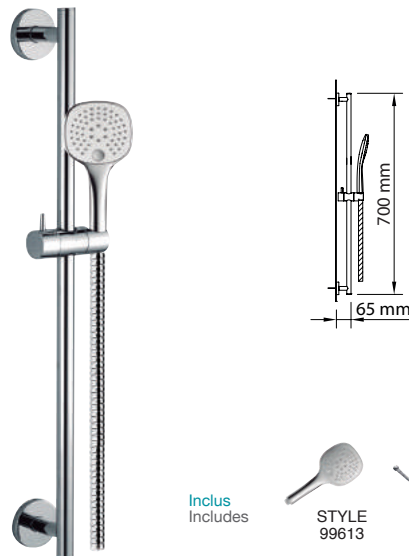

Inclus
Includes



STYLE
99613

1,75 m
97670

STYLE
ENSEMBLE BARRE DE DOUCHE
Sliding bar set
ABS

Ref.	€	📦
ø19x700 mm 99627	83,00	15
ø19x900 mm 99628	89,00	15

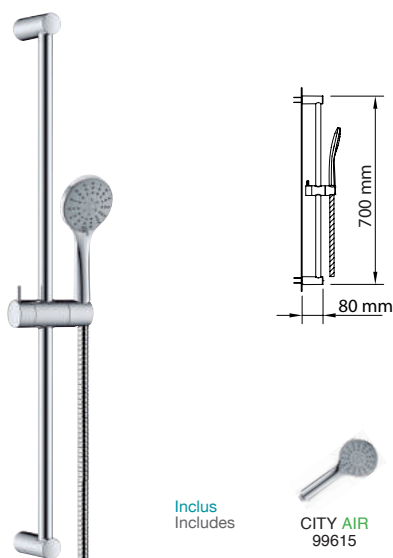

Inclus
Includes



CITY AIR
99615

1,75 m
97670

CITY AIR
ENSEMBLE BARRE DE DOUCHE
Sliding bar set
ABS

Ref.	€	📦
ø19x700 mm 99624	64,00	15
ø19x900 mm 99625	69,00	15

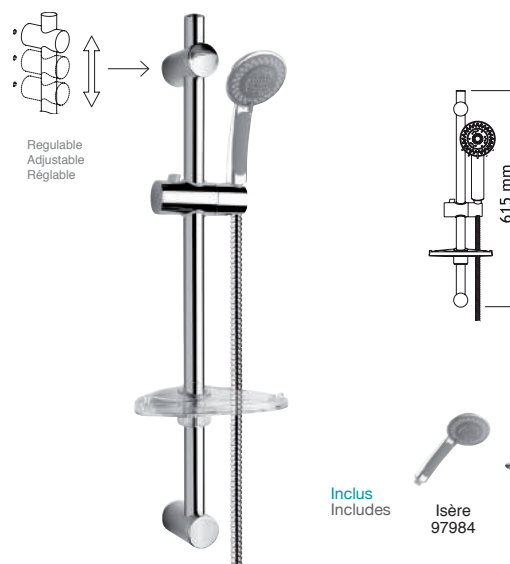

Inclus
Includes



Isère
97984

1,75 m
97670

MICHIGAN - Ø25x615 mm
ENSEMBLE BARRE DE DOUCHE
Sliding bar set

Porte savon amovible. ABS.
ABS Shower kit and adjustable rail with rub clean handset and removable soap dish.

Ref.	€	📦
ACS 97988	89,00	2



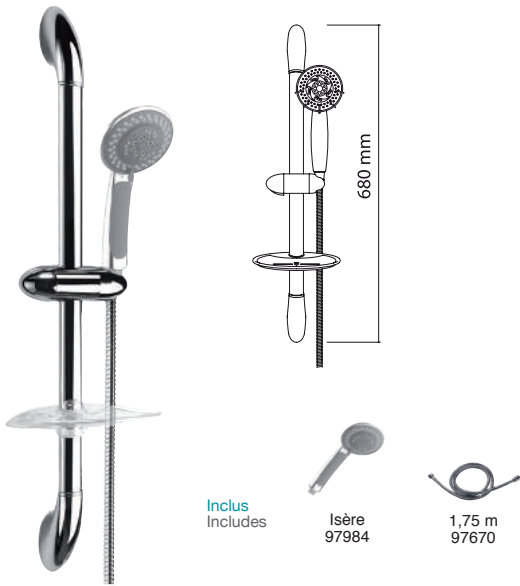

Inclus
Includes

Isère
97984

1,75 m
97670

LEMAN - 680 mm
ENSEMBLE BARRE DE DOUCHE
Sliding bar set

Barra de ducha ABS con jabonera extraíble.
ABS Shower kit and adjustable riser rail with rub clean handset and removable soap dish.
Porte savon amovible. ABS.

Ref.	€	
97986	83,00	2

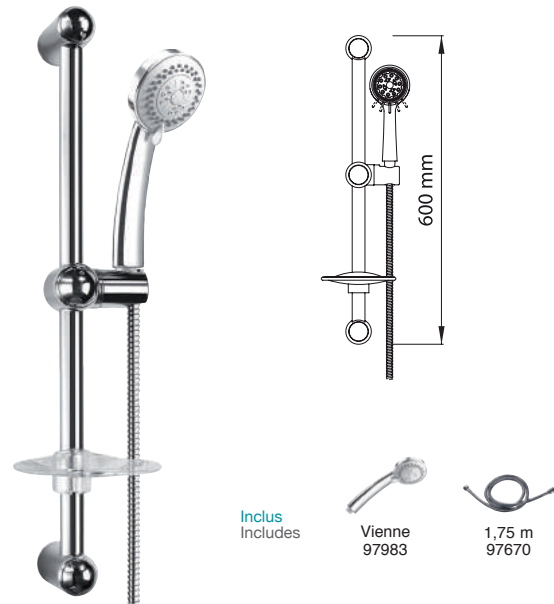

Inclus
Includes

Vienne
97983

1,75 m
97670

BAIKAL - Ø25x600 mm
ENSEMBLE BARRE DE DOUCHE
Sliding bar set

Porte savon amovible. ABS.
ABS Shower kit and adjustable riser rail with rub clean handset and removable soap dish.

Ref.	€	
97985	71,00	2

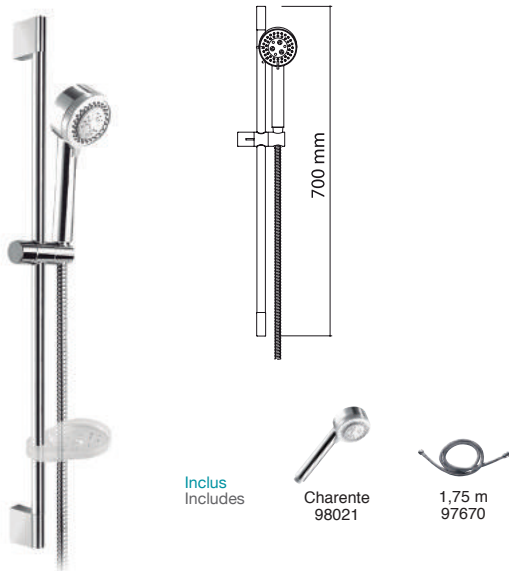

Inclus
Includes

Charente
98021

1,75 m
97670

VICTORIA - Ø20x700 mm
ENSEMBLE BARRE DE DOUCHE
Sliding bar set

Porte savon amovible. ABS.
ABS Shower kit and adjustable rail with rub clean handset and removable soap dish.

Ref.	€	
97987	71,00	2

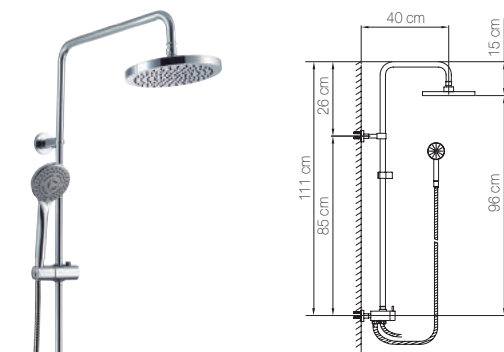

NON EXTENSIBLE / NOT EXTENSIBLE

Inclus
Includes

Circular
98518

Syvari
98884

1,75 m
97670

0,35 m
97396

Support
98998

Kit box
99172

ø20
98997

KIT BOX
COLONNE DE DOUCHE
Shower bar set

Ref.	€	
99623	224,00	1

Barres de douche *Shower kits*

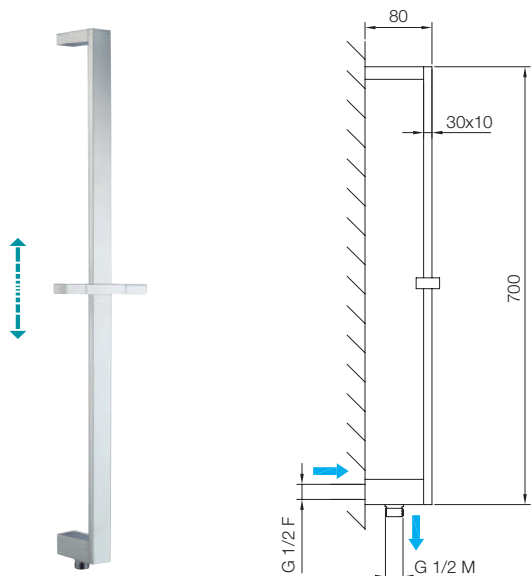

TREND - 30x10x700 mm
BARRE DE DOUCHE ENCASTRÉ
Concealed sliding bar



	Ref.	€	
BRASS	60690	148,00	-

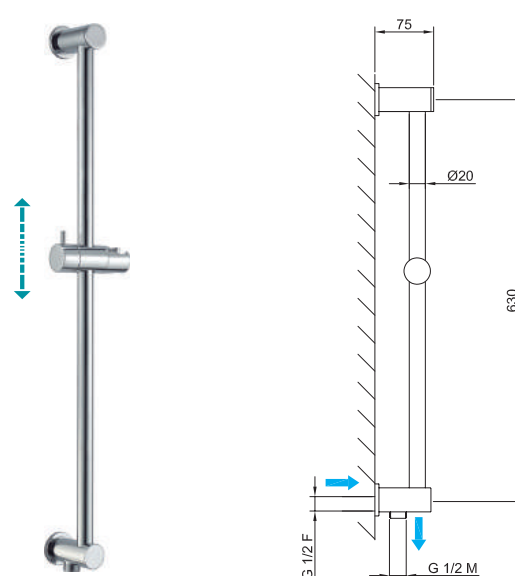

CITY - Ø20x715 mm
BARRE DE DOUCHE ENCASTRÉ
Concealed sliding bar



	Ref.	€	
BRASS	60691	121,00	-

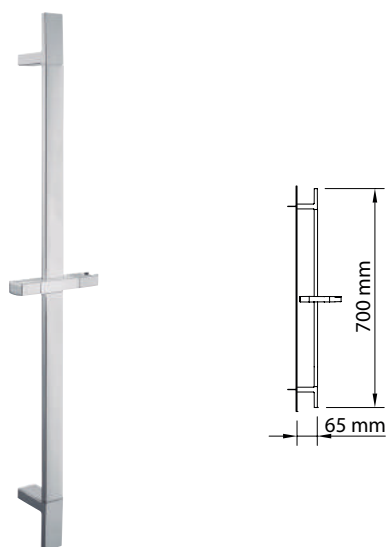

TREND 30x10x700 mm
BARRE DE DOUCHE
Sliding bar

	Ref.	€	
	99620	68,00	10

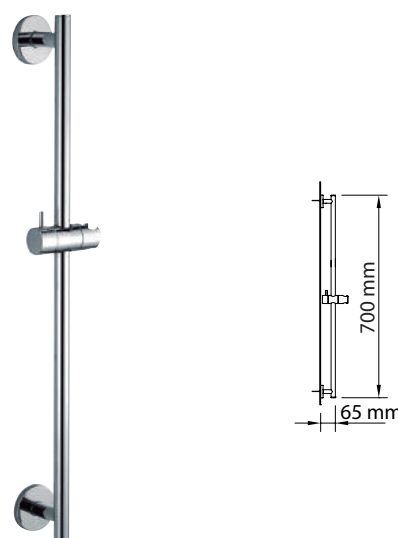

STYLE
BARRE DE DOUCHE
Sliding bar

	Ref.	€	
Ø19x700 mm	99621	42,00	15
Ø19x900 mm	99622	55,00	15



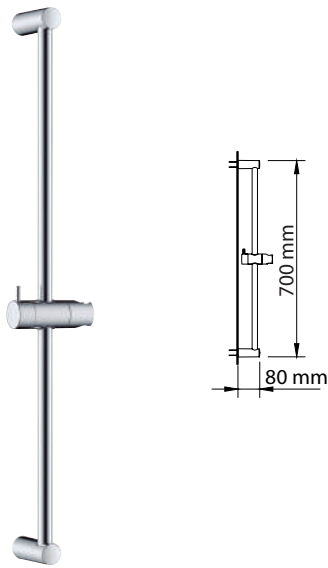

CITY
BARRE DE DOUCHE
Sliding bar

	Ref.	€	📦
ø19x700 mm	99618	41,00	15
ø19x900 mm	99619	43,00	15

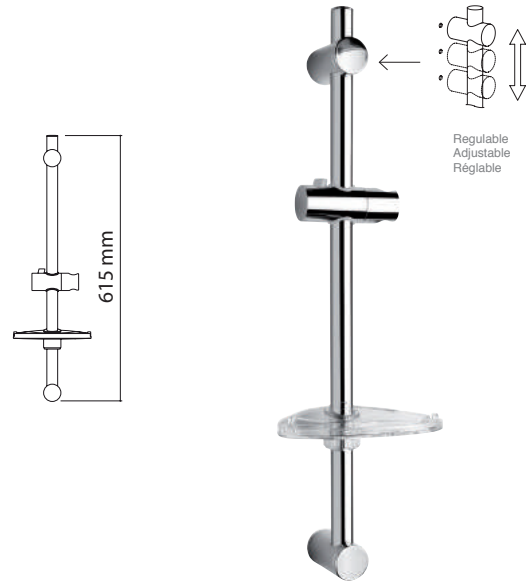

EIRE ø25x615 mm
BARRE DE DOUCHE
Sliding bar

Porte savon amovible. / Removable soap dish.

	Ref.	€	📦
	97992	59,00	2

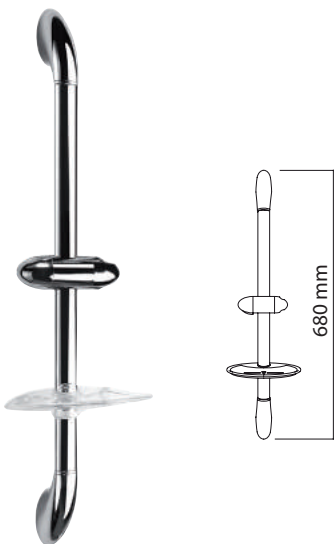

GARDA 680 mm
BARRE DE DOUCHE
Sliding bar

Porte savon amovible. / Removable soap dish.

	Ref.	€	📦
	97990	55,00	2

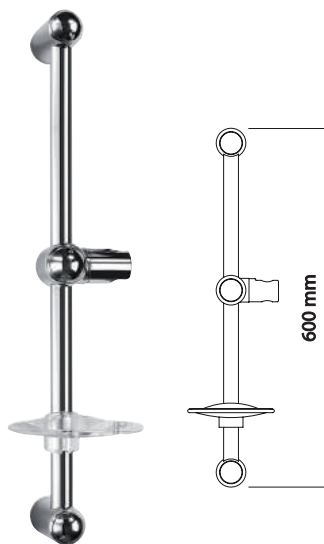

ARAL ø25x600 mm
BARRE DE DOUCHE
Sliding bar

Porte savon amovible. / Removable soap dish.

	Ref.	€	📦
	97989	48,00	2

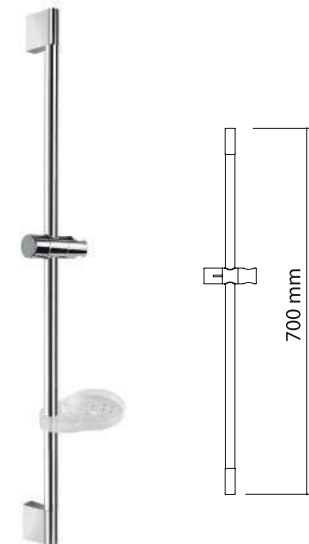

MALAWI ø20x700 mm
BARRE DE DOUCHE
Sliding bar

Porte savon amovible. / Removable soap dish.

	Ref.	€	📦
	97991	46,00	2



Pommes de douche *Shower heads*

ANGEL
630X245 mm

Pomme de douche encastrée
Concealed shower head

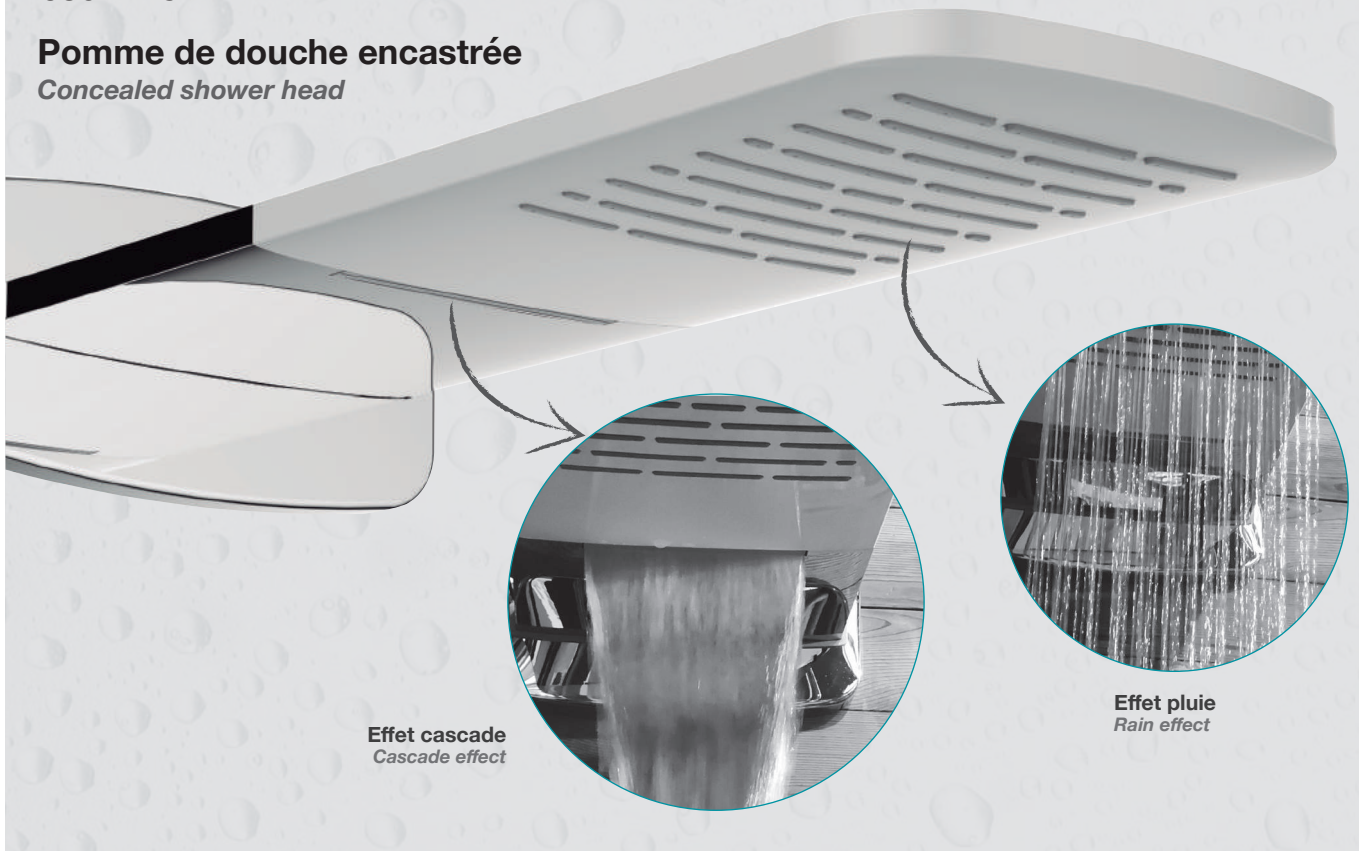

Effet cascade
Cascade effect

Effet pluie
Rain effect

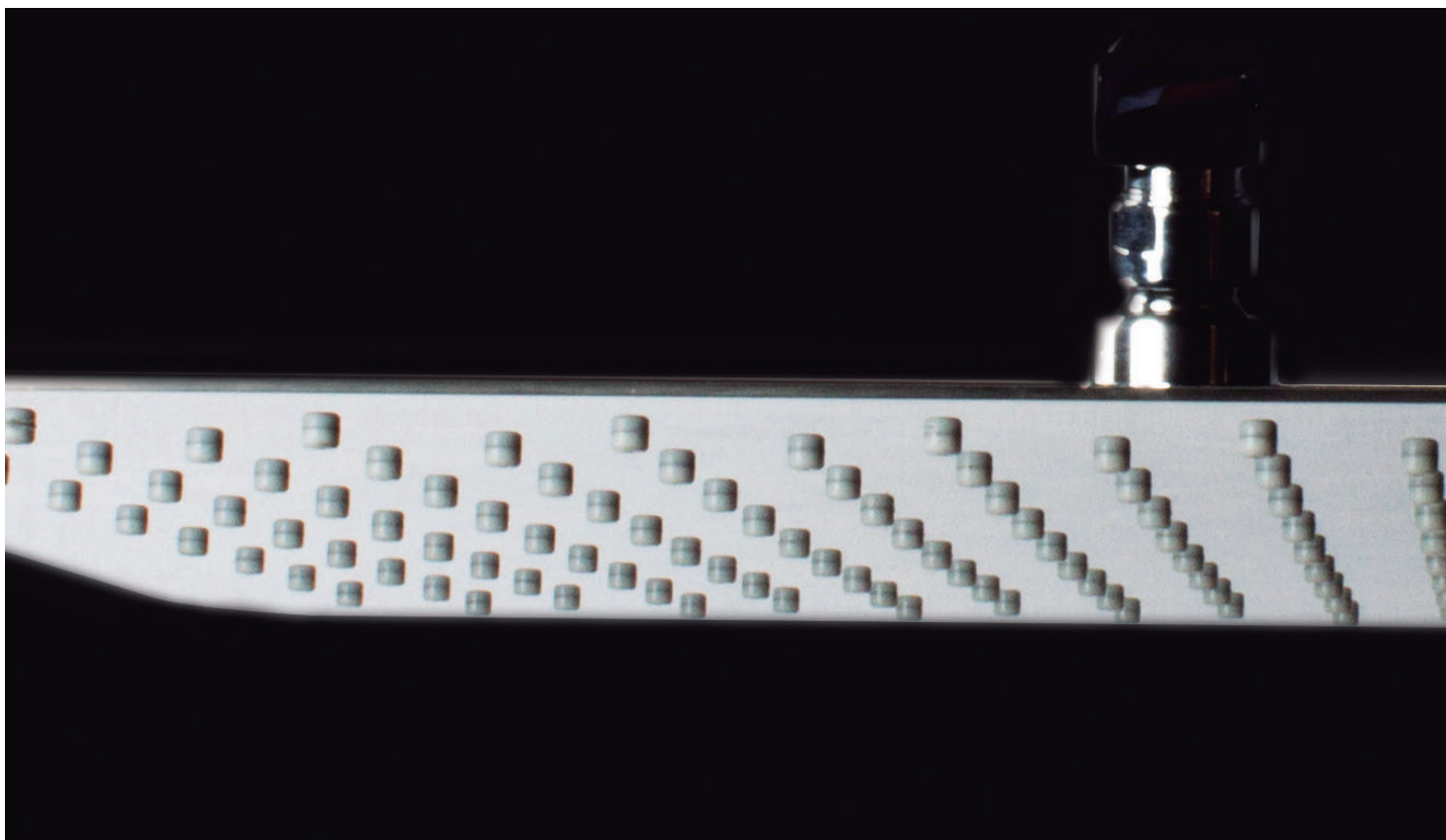

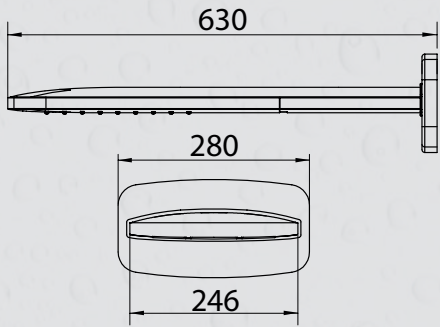

Silicone
Silicone rubber

Finition blanc
White finish

Finition chrome
Chrome finish



Ref.	€	
60308	507,00	-

Pomme de douche encastrée avec effet pluie et cascade. 2 voies.
Concealed shower head with rain and waterfall effect. 2 outlet diverter.

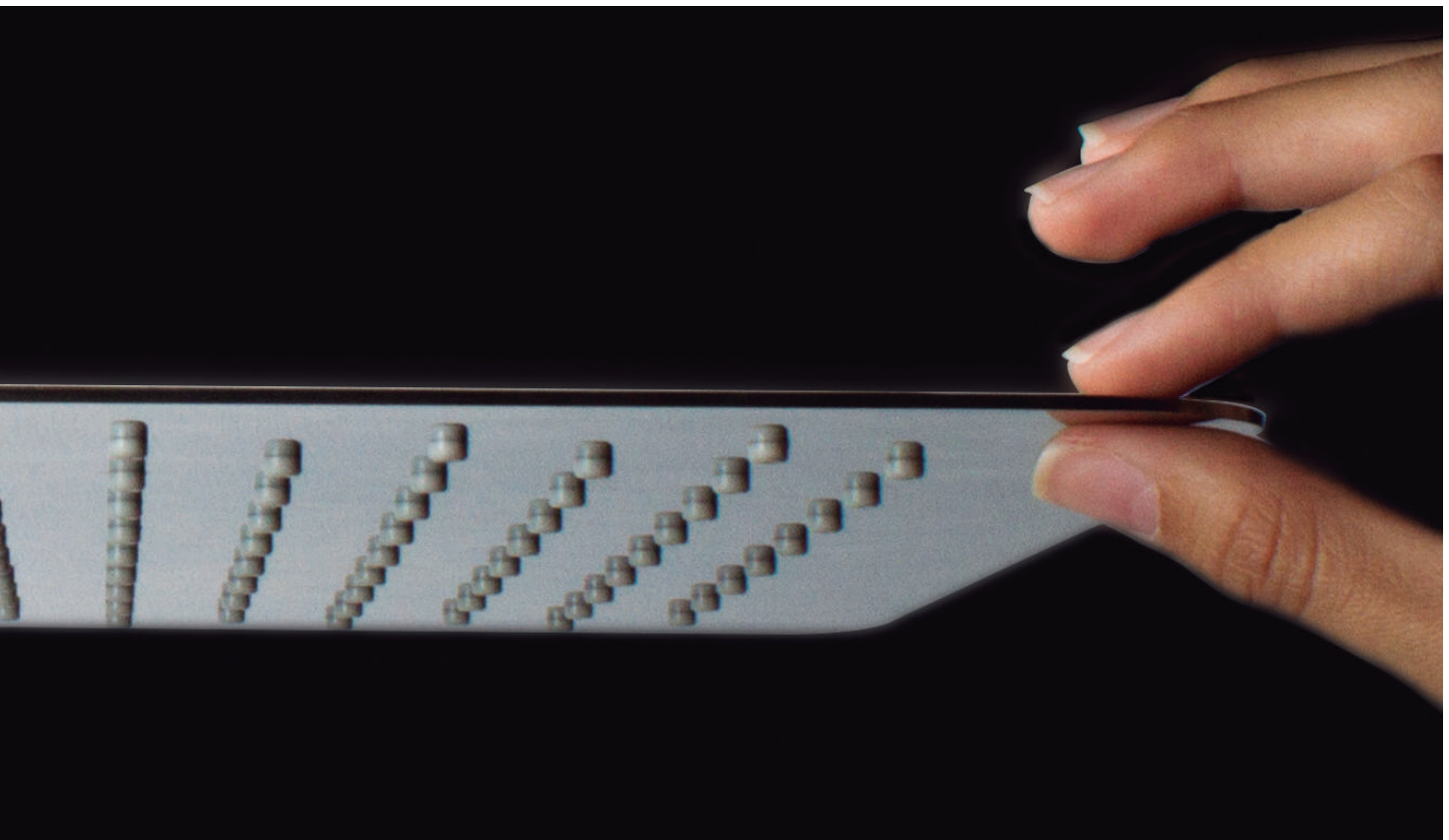

Pommes de douche *Shower heads*



Technologie AIR / AIR Technology

Tech AIR

Les pommes de douche Clever sont équipées de la technologie AIR Advanced la plus avancée. L'injection d'air avant la sortie d'eau permet de donner du volume aux gouttes, et d'obtenir une sensation plus douce et confortable sous la douche. Elle permet aussi d'économiser jusqu'à 30% de consommation d'eau et d'énergie.

Clever shower heads use the advanced technology AIR Advanced. Mixing air with the incoming water reduces the water consumption at least 30%.



-30%
Water reduce

1 Fonction

SLIM INOX AIR

Pomme de douche inox, anti calcaire.
Stainless steel Shower head, swivel, smart lime cleaning.

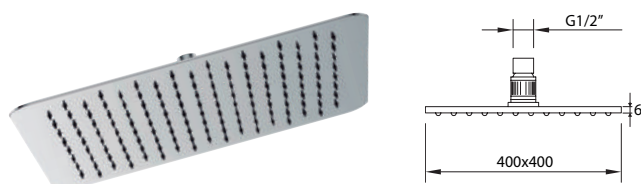

	Ref.	€	📦
400x400 mm	INOX AIR 99688	225,00	5
300x300 mm	INOX AIR 99693	120,00	8
250x250 mm	INOX AIR 99692	90,00	8
200x200 mm	INOX AIR 99600	65,00	12



	Ref.	€	📦
Ø400 mm	INOX AIR 99689	225,00	5
Ø300 mm	INOX AIR 99691	120,00	8
Ø250 mm	INOX AIR 99690	90,00	8
Ø200 mm	INOX AIR 99603	65,00	12

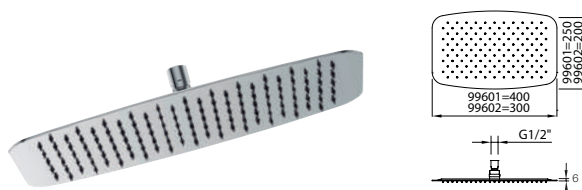

	Ref.	€	📦
400x250 mm	INOX AIR 99601	225,00	5
300x200 mm	INOX AIR 99602	139,00	8

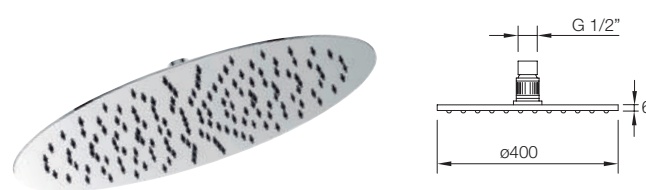

	Ref.	€	📦
Ø400 mm	INOX 97276	225,00*	-
SLIM Ø300 mm	INOX 98899	99,00*	-

* Jusqu'à épuisement des stocks / While stocks last

1
Fonction
Function

LAITON Brass

Pomme de douche laiton anti calcaire.
Brass Shower head, swivel, smart lime cleaning.



INFINITY
200X200 mm

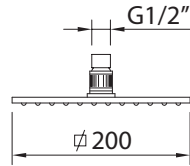

Ref.	€	Icon
ACS BRASS 99685	166,00	12

BIMINI
145x200 mm

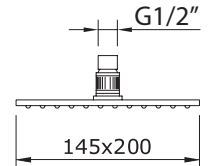

Ref.	€	Icon
BRASS 99686	157,00	12

MINAMI
Ø200 mm

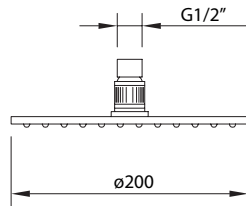

Ref.	€	Icon
ACS BRASS 99687	142,00	12

TAMPA
Ø150 mm

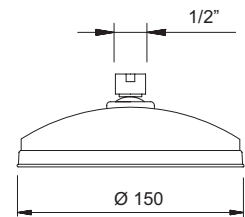

Ref.	€	Icon
BRASS 96437	87,00	8

1
Fonction
Function

ABS AIR

Pomme de douche ABS anti calcaire.
ABS Shower head, swivel, smart lime cleaning.



HEXAGON AIR
Ø230 mm

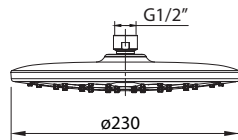
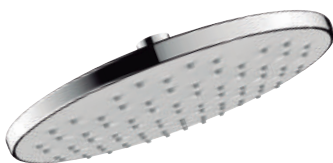

Ref.	€	Icon
ACS ABS AIR 60306	37,00	-

SYVARI EVO AIR
Ø225 mm

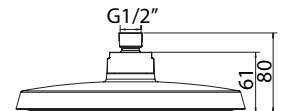

Ref.	€	Icon
ACS ABS AIR 60301	37,00	8

STYLE AIR
240X190 mm

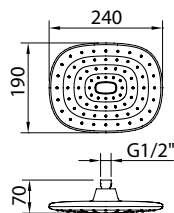

Ref.	€	Icon
ACS ABS AIR 99606	39,00	32

ROUND AIR
Ø120 mm

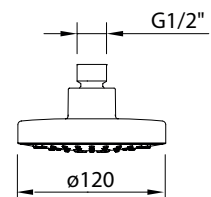

Ref.	€	Icon
ACS ABS AIR 99604	25,00	60

Pommes de douche *Shower heads*

1
Fonction
Function

ABS

Pomme de douche ABS anti calcaire.
ABS Shower head, swivel, smart lime cleaning.



BEAM Ø230 mm

Avec sortie d'eau à haute pression vaporisée.
High pressure outlet with spray water sensation.

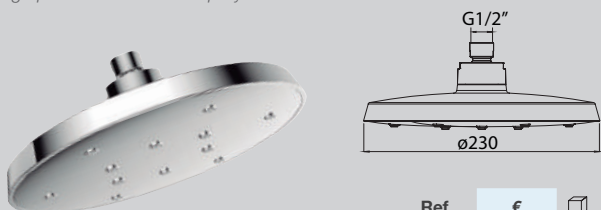

Ref.	€	
ABS BEAM 60303	58,00	-

SLIM CIRCULAR Ø300 mm

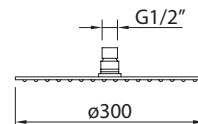

Ref.	€	
ABS 98892	139,00	1

TREND 260x190 mm

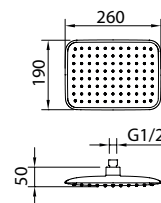
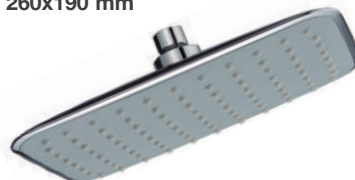

Ref.	€	
ABS 99608	44,00	24

CITY Ø225 mm

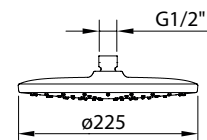

Ref.	€	
ABS 99607	35,00	20

KUBE 200X200 mm

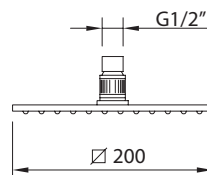

Ref.	€	
ABS 98672	44,00	1

CIRCULAR Ø200 mm

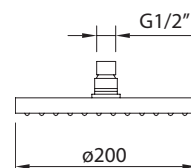

Ref.	€	
ABS 98518	44,00	16



3 Fonctions
Functions

ABS

Pomme de douche ABS anti calcaire.
ABS Shower head, smart lime cleaning.



ZANZIBAR
Ø80 mm

Avec bras de douche
With shower arm

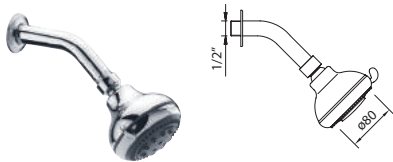

	Ref.	€	📦
	96141	26,00	50

ZANZIBAR
Ø80 mm

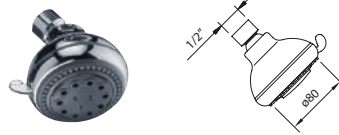

	Ref.	€	📦
	96114	17,00	50

KYOVA
Ø80 mm

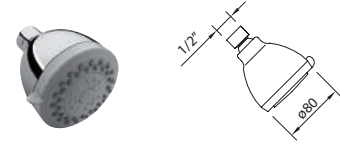

	Ref.	€	📦
	97996	16,00	5

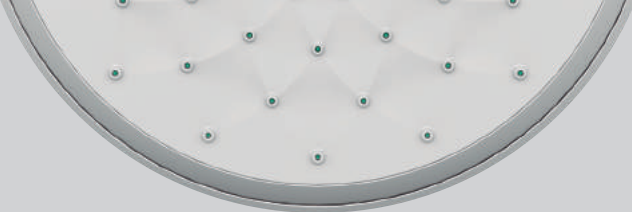

AUTOCLEAN
Ø230 mm



	Ref.	€	📦
	60305	62,00	1

Pomme de douche autoclean

Autoclean shower head



La pomme de douche auto-nettoyante évite l'entartrage des jets d'eau, grâce à un dispositif intégré qui combine gravité et pression d'eau pour nettoyer les orifices.

The shower rain self-cleaning avoids the water outlets to be blocked due to an internal system with needles.



Ce dispositif permet au jet d'eau de conserver sa trajectoire originale vous offrant une sensation de pluie naturelle en permanence.

The system maintains the original water trajectory offering a natural rain sensation.

Ventu

Accessoires de salle de bain Bathroom accessories

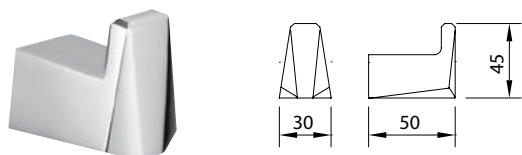

PATÈRE VENTU Clothes hook

Laiton chromé. Kit de fixation inclus.
Brass chromed. Fixing set included.

Ref.	€	📦
99470	19,00	30



PORTE-SAVON VENTU Soap Dish

Porte-savon mural en verre. Kit de fixation inclus.
Wall mounted frosted glass soap dish. Fixing set included.

Ref.	€	📦
99471	48,00	10



PORTE-SAVON VENTU Soap Dish

Porte-savon mural. Kit de fixation inclus.
Wall mounted soap dish. Fixing set included.

Ref.	€	📦
99472	64,00	10

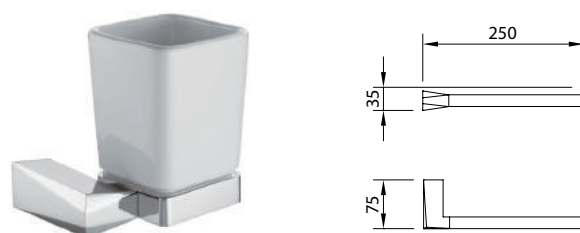

PORTE-VERRE VENTU Brush holder

Laiton chromé. Kit de fixation inclus.
Brass chromed. Fixing set included.

Ref.	€	📦
99473	46,00	10



PORTE-SERVIETTE VENTU Towel rail

Laiton chromé. Kit de fixation inclus.
Brass chromed. Fixing set included.

Ref.	€	📦
99474	42,00	10



PORTE-ROULEAU VENTU Toilet roll

Laiton chromé. Kit de fixation inclus.
Brass chromed. Fixing set included.

Ref.	€	📦
99475	54,00	10



PORTE-ROULEAU SANS COUVERCLE VENTU
Tissue holder without cover

Laiton chromé. Kit de fixation inclus.
Brass chromed. Fixing set included.

Ref.	€	📦
99476	39,00	10

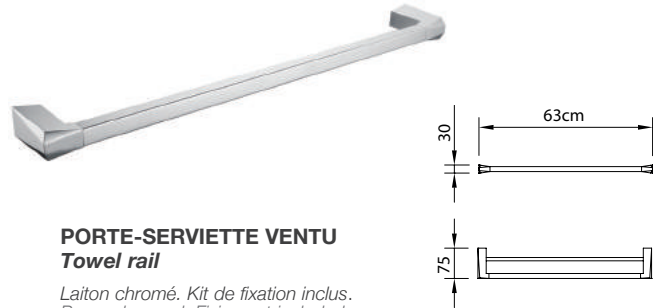

PORTE-SERVIETTE VENTU
Towel rail

Laiton chromé. Kit de fixation inclus.
Brass chromed. Fixing set included.

	Ref.	€	📦
40cm	60156	76,00	12
63cm	99477	81,00	10

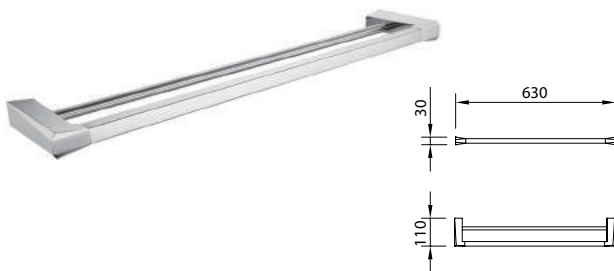

PORTE-SERVIETTE DOUBLE-BARRE VENTU
Double towel rail

Laiton chromé. Kit de fixation inclus.
Brass chromed. Fixing set included.

Ref.	€	📦
99478	101,00	10

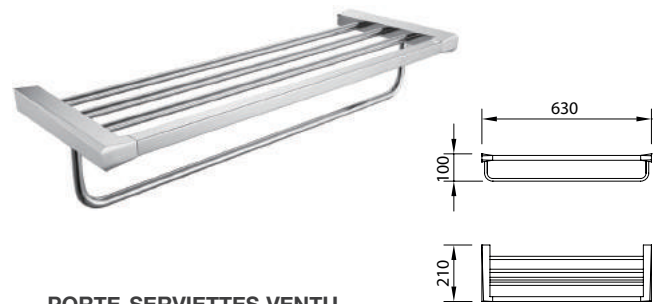

PORTE-SERVIETTES VENTU
Towel rack

Laiton chromé. Kit de fixation inclus.
Brass chromed. Fixing set included.

Ref.	€	📦
99479	166,00	4

PORTE BALAI WC MURAL VENTU
Toilet brush holder

Cristal glacé. Laiton chromé. Kit de fixation inclus.
Frosted glass. Brass chromed. Fixing set included.



Ref.	€	📦
60563	97,00	-



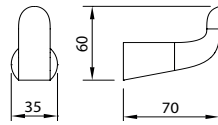

PATÈRE
Clothes hook

Laiton chromé. Kit de fixation inclus.
Brass chromed. Fixing set included.

Ref.	€	📦
99451	20,00	30

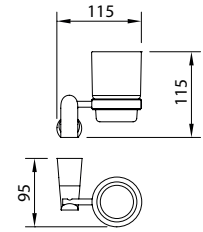

PORTE-VERRE
Brush holder

Laiton chromé. Kit de fixation inclus.
Brass chromed. Fixing set included.

Ref.	€	📦
99453	34,00	10

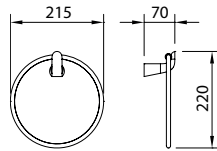

PORTE-SERVIETTE ANNEAU
Towel ring

Laiton chromé. Kit de fixation inclus.
Brass chromed. Fixing set included.

Ref.	€	📦
99454	37,00	10

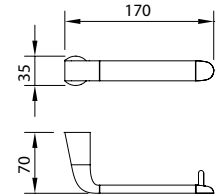

PORTE-ROULEAU SANS COUVERCLE
Tissue holder without cover

Laiton chromé. Kit de fixation inclus.
Brass chromed. Fixing set included.

Ref.	€	📦
99455	34,00	10

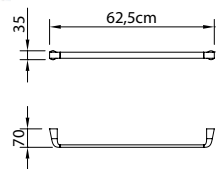

PORTE-SERVIETTE
Towel rail

Laiton chromé. Kit de fixation inclus.
Brass chromed. Fixing set included.

	Ref.	€	📦
40 cm	60157	50,00	12
62,5 cm	99456	65,00	10

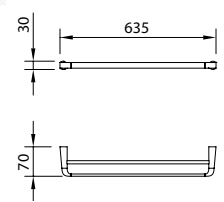

PORTE-SERVIETTE DOUBLE-BARRE
Double towel rail

Laiton chromé. Kit de fixation inclus.
Brass chromed. Fixing set included.

Ref.	€	📦
99457	93,00	10

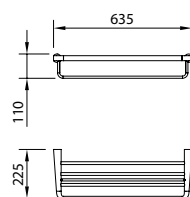

PORTE-SERVIETTES
Towel rack

Laiton chromé. Kit de fixation inclus.
Brass chromed. Fixing set included.

Ref.	€	📦
99458	166,00	4



PORTE BALAI WC MURAL
Toilet brush holder

Céramique. Laiton chromé. Kit de fixation inclus.
Ceramic. Brass chromed. Fixing set included

Ref.	€	📦
60564	50,00	-

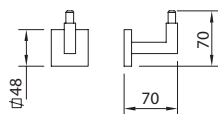

PATÈRE Clothes hook

Laiton chromé. Kit de fixation inclus.
Brass chromed. Fixing set included.

Ref.	€	📦
98655	25,00	30

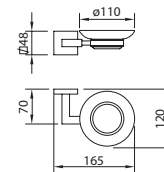

PORTE-SAVON Soap Dish

Porte-savon mural de cristal glacé. Kit de fixation inclus.
Wall mounted frosted glass soap dish. Fixing set included.

Ref.	€	📦
98824	33,00	10

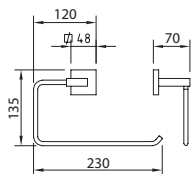
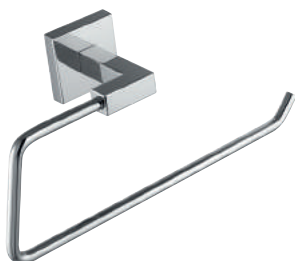

PORTE-SERVIETTE ANNEAU Towel ring

Laiton chromé. Kit de fixation inclus.
Brass chromed. Fixing set included.

Ref.	€	📦
98656	36,00	10

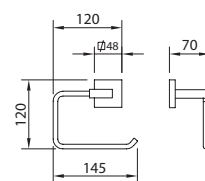

PORTE-ROULEAU Toilet roll

Laiton chromé. Kit de fixation inclus.
Brass chromed. Fixing set included.

Ref.	€	📦
98657	34,00	10

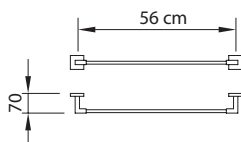

PORTE-SERVIETTE Towel rail

Laiton chromé. Kit de fixation inclus.
Brass chromed. Fixing set included.

	Ref.	€	📦
40 cm	60158	43,00	12
56 cm	98658	53,00	10

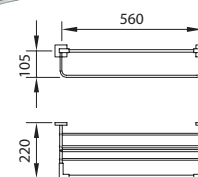

PORTE-SERVIETTE Towel shelf

Laiton chromé. Kit de fixation inclus.
Brass chromed. Fixing set included.

Ref.	€	📦
98659	128,00	4

PORTE BALAI WC MURAL Toilet brush holder

Cristal glacé. Laiton chromé. Kit de fixation inclus.
Frosted glass. Brass chromed. Fixing set included.



Ref.	€	📦
60565	43,00	-



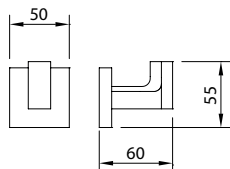

PATÈRE
Clothes hook

Laiton chromé. Kit de fixation inclus.
Brass chromed. Fixing set included.

Ref.	€	📦
99459	23,00	30

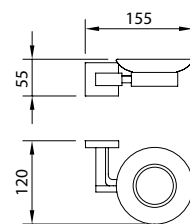

PORTE-SAVON
Soap Dish

Porte-savon mural en verre. Kit de fixation inclus.
Wall mounted frosted glass soap dish. Fixing set included.

Ref.	€	📦
99460	34,00	10

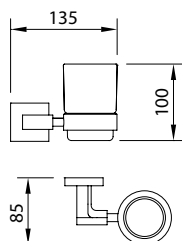

PORTE-VERRE
Brush holder

Laiton chromé. Kit de fixation inclus.
Brass chromed. Fixing set included.

Ref.	€	📦
99461	33,00	10

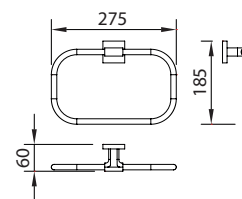

PORTE-SERVIETTE ANNEAU
Towel ring

Laiton chromé. Kit de fixation inclus.
Brass chromed. Fixing set included.

Ref.	€	📦
99462	47,00	10

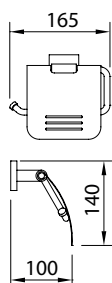

PORTE-ROULEAU
Toilet roll

Laiton chromé. Kit de fixation inclus.
Brass chromed. Fixing set included.

Ref.	€	📦
99463	43,00	10

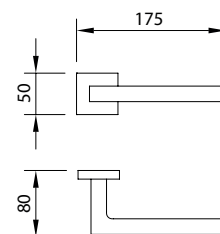

PORTE-ROULEAU SANS COUVERCLE
Tissue holder without cover

Laiton chromé. Kit de fixation inclus.
Brass chromed. Fixing set included.

Ref.	€	📦
99464	32,00	10

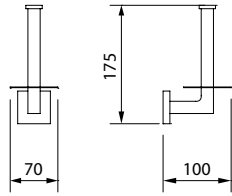

PORTE-ROULEAU
Toilet roll

Laiton chromé. Kit de fixation inclus.
Brass chromed. Fixing set included.

Ref.	€	📦
99465	35,00	10

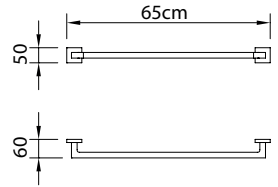

PORTE-SERVIETTE
Towel rail

Laiton chromé. Kit de fixation inclus.
Brass chromed. Fixing set included.

	Ref.	€	📦
40 cm	60159	50,00	12
65 cm	99466	55,00	10

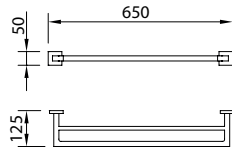

PORTE-SERVIETTE DOUBLE-BARRE
Double towel rail

Laiton chromé. Kit de fixation inclus.
Brass chromed. Fixing set included.

Ref.	€	📦
99467	86,00	10

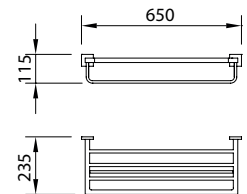

PORTE-SERVIETTE
Towel shelf

Laiton chromé. Kit de fixation inclus.
Brass chromed. Fixing set included.

Ref.	€	📦
99468	128,00	4



PORTE BALAI WC MURAL
Toilet brush holder

Céramique. Laiton chromé. Kit de fixation inclus.
Ceramic. Brass chromed. Fixing set included

Ref.	€	📦
60566	68,00	-

SLIM

Accessoires de salle de bain Bathroom accessories

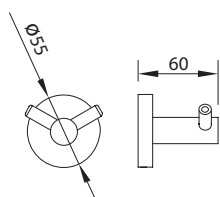

PATÈRE Clothes hook

Laiton chromé. Kit de fixation inclus.
Brass chromed. Fixing set included.

Ref.	€	📦
98650	14,00	30

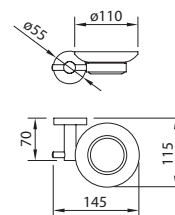

PORTE-SAVON Soap Dish

Porte-savon mural en verre. kit de fixation inclus.
Wall mounted frosted glass soap dish. Fixing set included.

Ref.	€	📦
98825	27,00	10

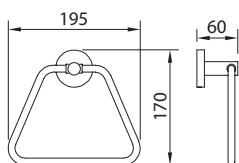

PORTE-SERVIETTE ANNEAU Towel ring

Laiton chromé. Kit de fixation inclus.
Brass chromed. Fixing set included.

Ref.	€	📦
98651	30,00	10

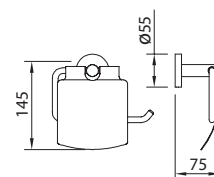

PORTE-ROULEAU Toilet roll

Laiton chromé. Kit de fixation inclus.
Brass chromed. Fixing set included.

Ref.	€	📦
98652	35,00	12

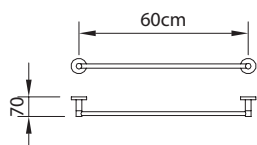

PORTE-SERVIETTE Towel rail

Laiton chromé. Kit de fixation inclus.
Brass chromed. Fixing set included.

	Ref.	€	📦
40cm	60160	35,00	12
60cm	98653	38,00	12

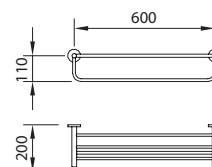

PORTE-SERVIETTE Towel shelf

Laiton chromé. Kit de fixation inclus.
Brass chromed. Fixing set included.

Ref.	€	📦
98654	87,00	4

x3
Magnification

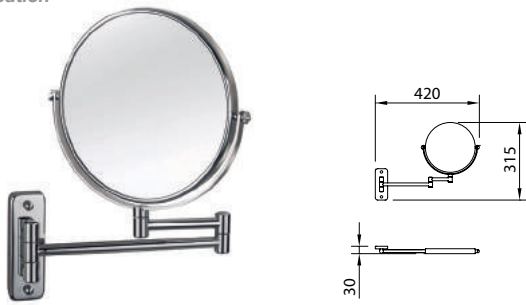

MIROIR GROSSISSANT
Augmented mirror

Miroir double face avec vision normale et grossissement x 3.
Laiton chromé. Kit de fixation inclus.
Double sided. One side with normal vision and one side with 3 x magnification. Brass chromed. Fixing set included.

Ref.	€	📦
99469	109,00	8

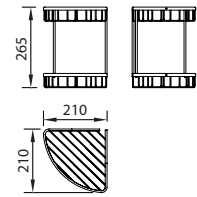

ETAGÈRE D'ANGLE CHROMÉE
Chromed soap double holder

Laiton chromé. Kit de fixation inclus.
Brass chromed. Fixing set included.

Ref.	€	📦
99480	102,00	8

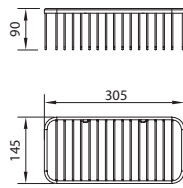

ETAGÈRE DROITE CHROMÉE
Chromed soap dish basket

Laiton chromé. Kit de fixation inclus.
Brass chromed. Fixing set included.

Ref.	€	📦
98826	48,00	10

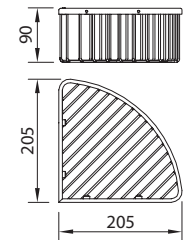

ETAGÈRE D'ANGLE CHROMÉE
Chromed corner soap dish basket

Laiton chromé. Kit de fixation inclus.
Brass chromed. Fixing set included.

Ref.	€	📦
98827	43,00	10



PORTE BALAI WC MURAL
Toilet brush holder

Cristal glacé. Laiton chromé. Kit de fixation inclus.
Frosted glass. Brass chromed. Fixing set included.

Ref.	€	📦
60567	37,00	-

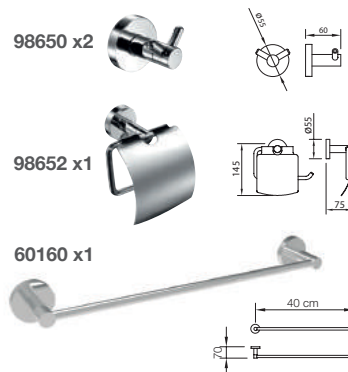

PRÉSENTOIR DE COMPTOIR
4 ACCESSOIRES BATH BOX
Floorstand 4 Accessories Bath Box

Ref.	€	📦
99450	95,00	8*

*(Pack indivisible de 8 unités)
*(Indivisible Packaging of 8 units)

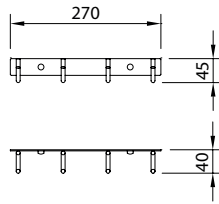

BARRE 4 CROCHETS Clothes hook

Laiton chromé. Kit de fixation inclus.
Brass chromed. Fixing set included.

Ref.	€	📦
99481	23,00	30

INOX

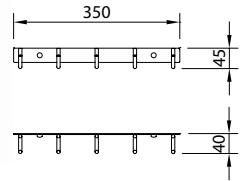

BARRE 5 CROCHETS Clothes hook

Laiton chromé. Kit de fixation inclus.
Brass chromed. Fixing set included.

Ref.	€	📦
99482	28,00	30

INOX

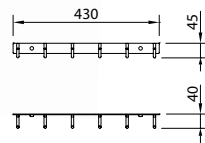

BARRE 6 CROCHETS Clothes hook

Laiton chromé. Kit de fixation inclus.
Brass chromed. Fixing set included.

Ref.	€	📦
99483	33,00	30

INOX

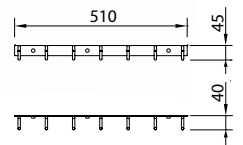

BARRE 7 CROCHETS Clothes hook

Laiton chromé. Kit de fixation inclus.
Brass chromed. Fixing set included.

Ref.	€	📦
99484	38,00	30

INOX



99454
elegance
Porte-serviette anneau
Towel ring



Éviers Chef *Sink mixers*



industriel | professional



PVD
Physical
Vapor
Deposition

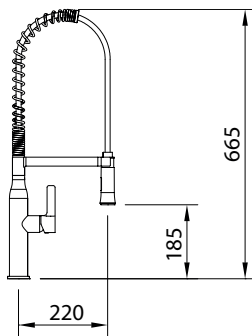

MATT Acabado en mate.
Matt finish. Fini mat

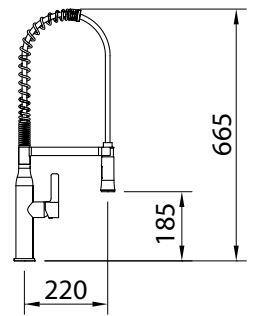

CHEF 5 MATT

MITIGEUR ÉVIER DOUCHETTE *Sink mixer*

Évier à bec orientable, ressort de guidage renforcé, douchette avec poussoir pré-lavage. Livré avec raccords flexibles M-10 3/8" x 370 mm.
Mixer with aerator, swivel spout, handset and flexible hoses M-10 3/8" x 370 mm.

Ref.	€	📦
99445	355,00	4



99659 97372 97688 99658
Luvia Rain-Plus Spray

CHEF 5

MITIGEUR ÉVIER DOUCHETTE *Sink mixer*

Évier à bec orientable, ressort de guidage renforcé, douchette avec poussoir pré-lavage. Livré avec raccords flexibles M-10 3/8" x 370 mm.
Mixer with aerator, swivel spout, handset and flexible hoses M-10 3/8" x 370 mm.

Ref.	€	📦
99444	317,00	4



99447 97372 98759 97688
Luvia Rain-Plus Spray

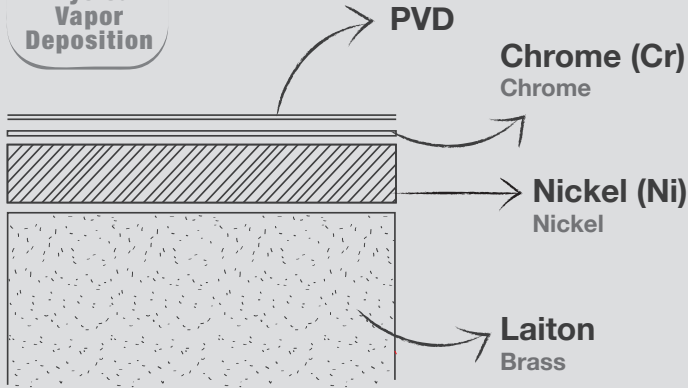

Technologie PVD. Physical Vapor Deposition

Processus de revêtement de nitrure de titane sous vide (PVD) créant une union moléculaire avec la pièce à couvrir.
Le revêtement se condense, formant une pellicule qui donne à la surface une grande résistance à l'usure, aux rayures, aux coups et à la corrosion.

Coating process where titanium nitride is vaporized and transported to an empty form with a molecular union to cover the piece. The coating is condensed, forming a film to create a surface with high resistance, postponing wear, scratches, blows and corrosion.

Pour / For:
Chef 5 MATT, 99445



MITIGEUR ÉVIER INDUSTRIEL 750 Sink mixer with swivel spout and dishwashing shower

Évier à bec orientable, ressort de guidage renforcé, douche avec gachette pré-lavage. Livré avec raccords flexibles M-10 3/8" x 600 mm.
Sink column, straight lateral spout, diverter, strong spring, dishwashing shower, hose 47cm. Flexible hoses M-10 3/8" x 600 mm.

Ref.	€	
750 mm	96365 538,00	4



Éviers Chef Design *Sink mixers*



Slim avec douchette | Slim with hand shower

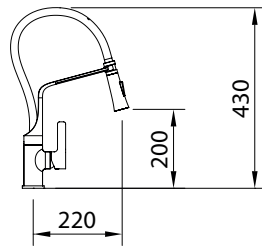

 **Finition blanc-Chrome**
White-Chrome finish.

CHEF 6 BLANC/CHROME

MITIGEUR ÉVIER DOUCHETTE *Sink mixer*

Évier à bec orientable, douchette avec poussoir prélavage. Livré avec raccords flexibles M-10 3/8" x 370 mm.
Mixer with aerator, swivel spout, handset and flexible hoses M-10 3/8" x 370 mm.

Ref.	€	
99733	254,00	4

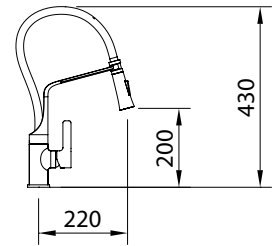

CHEF 6

MITIGEUR ÉVIER DOUCHETTE *Sink mixer*

Évier à bec orientable, douchette avec poussoir prélavage. Livré avec raccords flexibles M-10 3/8" x 370 mm.
Mixer with aerator, swivel spout, handset and flexible hoses M-10 3/8" x 370 mm.

Ref.	€	
99735	212,00	4





CHEF CARBON

MITIGEUR ÉVIER INDUSTRIEL

Sink mixer with swivel spout and dishwashing shower

Évier à bec orientable, douchette avec poussoir pré lavage. Livré avec raccords flexibles M-10 3/8" x 370 mm.
Mixer with aerator, swivel spout, handset and flexible hoses M-10 3/8" x 370 mm.

Ref.	€	📦
98757	305,00	4



98758 97372 98759 97688

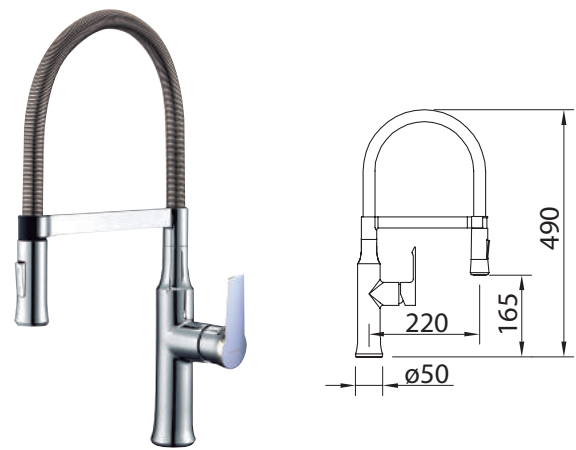

CHEF AGORA

MITIGEUR ÉVIER INDUSTRIEL

Sink mixer with swivel spout and dishwashing shower

Évier à bec orientable, douchette avec poussoir pré lavage. Livré avec raccords flexibles M-10 3/8" x 370 mm.
Mixer with aerator, swivel spout, handset and flexible hoses M-10 3/8" x 370 mm.

Ref.	€	📦
98764	290,00	4



95184 97372 98759 97688

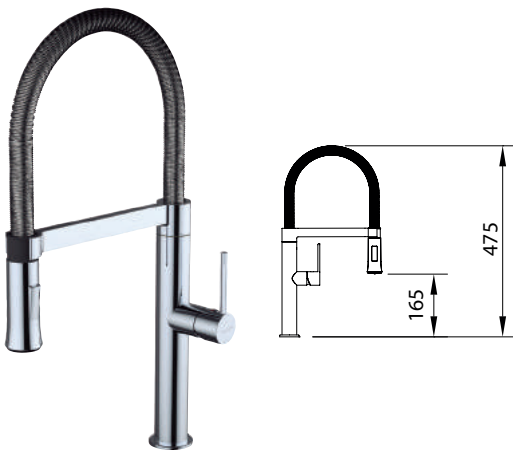

CHEF MAGNET SLIM

MITIGEUR ÉVIER DOUCHETTE

Sink mixer

Évier à bec orientable, douchette avec poussoir pré lavage. Livré avec raccords flexibles M-10 3/8" x 370 mm.
Mixer with aerator, swivel spout, handset and flexible hoses M-10 3/8" x 370 mm.

Ref.	€	📦
ec1 60142	269,00	4



95247 97824 98759 97688

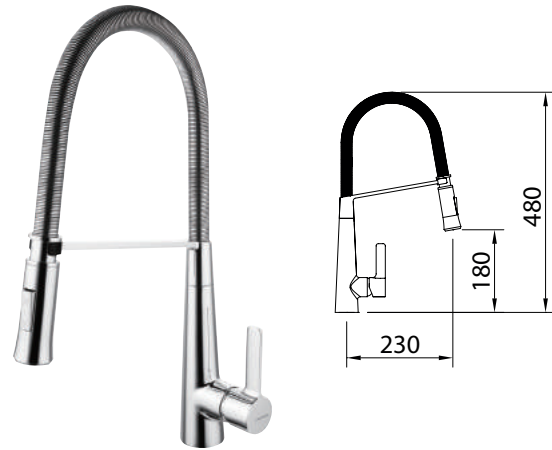

CHEF 4

MITIGEUR ÉVIER DOUCHETTE

Sink mixer

Évier à bec orientable, douchette avec poussoir pré lavage. Livré avec raccords flexibles M-10 3/8" x 420 mm.
Mixer with aerator, swivel spout, handset and flexible hoses M-10 3/8" x 420 mm.

Ref.	€	📦
99443	231,00	4



99447 99665 98759 97688

Éviers Chef Slim *Sink mixers*



CHEF SLIM

MITIGEUR ÉVIER *Sink mixer*

Évier à bec orientable. Livré avec raccords flexibles M-10 3/8" x 370 mm.
Mixer with aerator, handset and flexible hoses M-10 3/8" x 370 mm.

Ref.	€	📦
60143	191,00	4

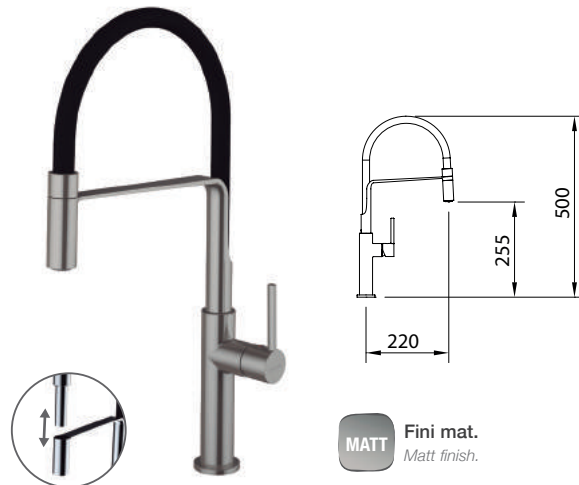

CHEF SLIM MAT

MITIGEUR ÉVIER *Sink mixer*

Évier à bec orientable. Livré avec raccords flexibles M-10 3/8" x 370 mm.
Mixer with aerator, handset and flexible hoses M-10 3/8" x 370 mm.

Ref.	€	📦
60144	212,00	4



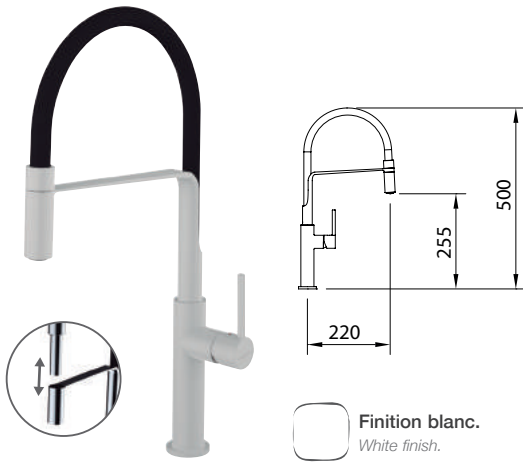

Finition blanc.
White finish.

CHEF SLIM BLANC
MITIGEUR ÉVIER
Sink mixer

Évier à bec orientable.. Livré avec raccords flexibles M-10 3/8" x 370 mm.
Mixer with aerator, handset and flexible hoses M-10 3/8" x 370 mm.

Ref.	€	📦
60145	212,00	4



60317 97824 97688

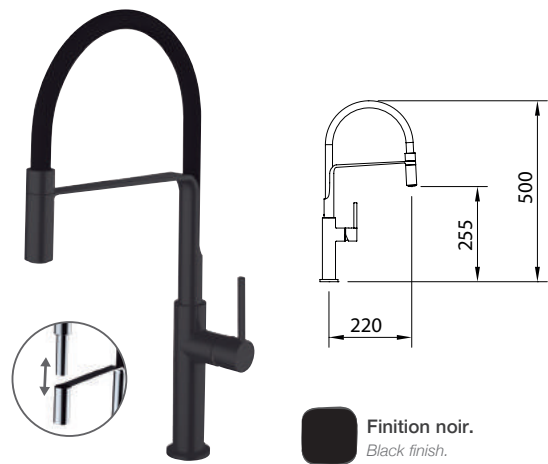

Finition noir.
Black finish.

CHEF SLIM NOIR
MITIGEUR ÉVIER
Sink mixer

Évier à bec orientable. Livré avec raccords flexibles M-10 3/8" x 370 mm.
Mixer with aerator, handset and flexible hoses M-10 3/8" x 370 mm.

Ref.	€	📦
60146	212,00	4



60318 97824 97688

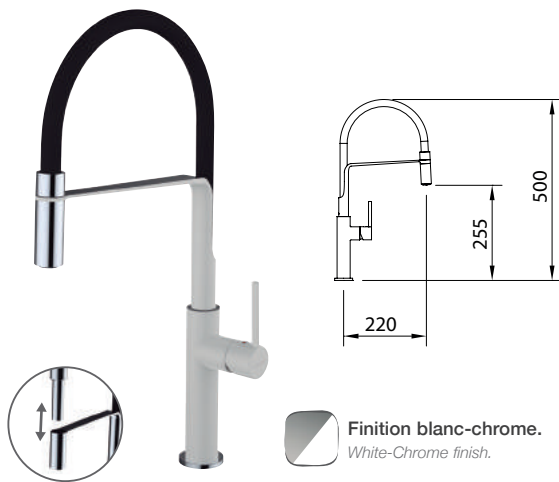

Finition blanc-chrome.
White-Chrome finish.

CHEF SLIM BLANC CHROME
MITIGEUR ÉVIER
Sink mixer

Évier à bec orientable. Livré avec raccords flexibles M-10 3/8" x 370 mm.
Mixer with aerator, handset and flexible hoses M-10 3/8" x 370 mm.

Ref.	€	📦
60147	228,00	4



60317 97824 97688

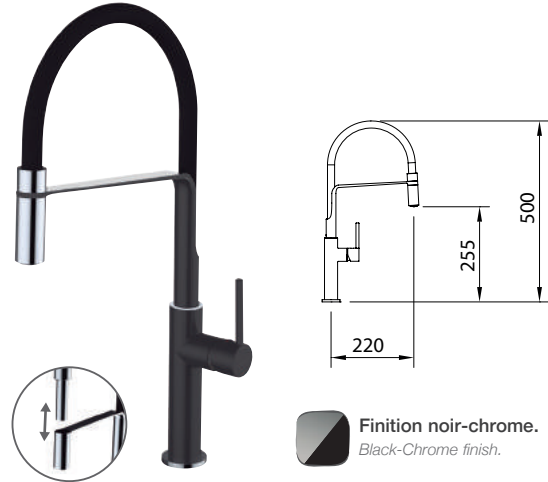

Finition noir-chrome.
Black-Chrome finish.

CHEF SLIM NOIR CHROME
MITIGEUR ÉVIER
Sink mixer

Évier à bec orientable. Livré avec raccords flexibles M-10 3/8" x 370 mm.
Mixer with aerator, handset and flexible hoses M-10 3/8" x 370 mm.

Ref.	€	📦
60148	228,00	4



60318 97824 97688

Éviers douchette Extractible *Sink mixers*

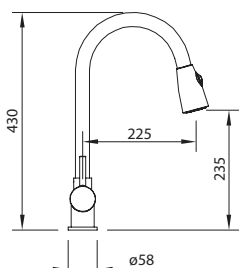

CAIMAN urban 235 mm
MITIGEUR ÉVIER DOUCHETTE EXTRACTIBLE
Pull-out sink mixer

Mitigeur évier bec orientable, douchette extractible, aérateur, raccords flexibles M-10 3/8" x 370 mm.
 Mixer with aerator, swivel spout, pull-out handshower and flexible hoses M-10 3/8" x 370 mm.

Inclus Includes	Ref.	€	Q
1,50 m 96117	97804	219,00	4

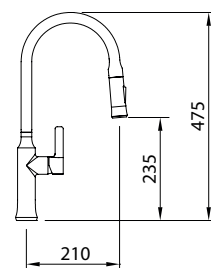

CHEF1
MITIGEUR ÉVIER DOUCHETTE EXTRACTIBLE
Pull-out sink mixer

Évier à bec orientable, douchette extractible avec poussoir pré lavage.
 Livré avec raccords flexibles M-10 3/8" x 370 mm.
 Mixer with aerator, swivel spout, pull-out handset and flexible hoses M-10 3/8" x 370 mm.

Ref.	€	Q
99440	183,00	4

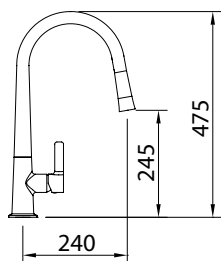

CHEF 3
MITIGEUR ÉVIER DOUCHETTE EXTRACTIBLE
Pull-out sink mixer

Évier à bec orientable, douchette extractible avec poussoir pré lavage.
 Livré avec raccords flexibles M-10 3/8" x 370 mm.
 Mixer with aerator, swivel spout, pull-out handset and flexible hoses M-10 3/8" x 370 mm.

Ref.	€	Q
99442	263,00	4

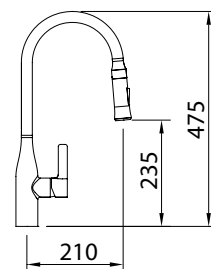

CHEF 2
MITIGEUR ÉVIER DOUCHETTE EXTRACTIBLE
Pull-out sink mixer

Évier à bec orientable, douchette extractible avec poussoir pré lavage.
 Livré avec raccords flexibles M-10 3/8" x 370 mm.
 Mixer with aerator, swivel spout, pull-out handset and flexible hoses M-10 3/8" x 370 mm.

Ref.	€	Q
99441	199,00	4



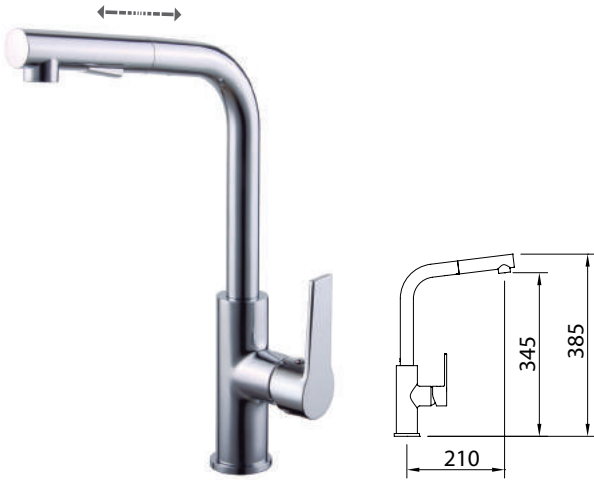

ARTIC xtreme 265 mm
MITIGEUR ÉVIER DOUCHETTE EXTRACTIBLE
Pull-out sink mixer

Mitigeur évier bec orientable, aérateur, douchette extractible avec poussoir pré-lavage, raccords flexibles M-10 3/8" x 370 mm.
 Mixer with aerator, swivel spout, pull-out handset and flexible hoses M-10 3/8" x 370 mm.

	Ref.	€	
	98689	197,00	4

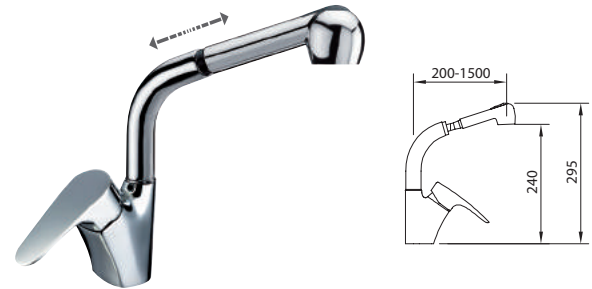

HABANA xtreme 240 mm
MITIGEUR ÉVIER DOUCHETTE EXTRACTIBLE
Pull-out sink mixer

Mitigeur évier bec orientable, douchette extractible, aérateur, raccords flexibles M-10 3/8" x 370 mm.
 Mixer with aerator, swivel spout, pull-out handset and flexible hoses M-10 3/8" x 370 mm.

	Ref.	€		Inclus Includes
	98552	126,00	12	

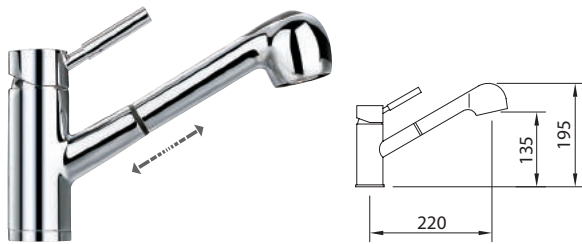

CAIMAN elegance 135 mm
MITIGEUR ÉVIER DOUCHETTE EXTRACTIBLE
Pull-out sink mixer

Mitigeur évier bec orientable, douchette extractible, aérateur, raccords flexibles M-10 3/8" x 370 mm.
 Mixer with aerator, swivel spout, flexible hoses M-10 3/8" x 370 mm.

	Ref.	€	
	97069	199,00	8

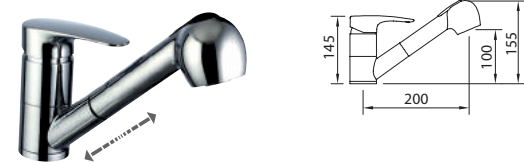

BAHAMA xtreme 100 mm
MITIGEUR ÉVIER DOUCHETTE EXTRACTIBLE
Pull-out sink mixer

Mitigeur évier bec orientable, douchette extractible, aérateur, raccords flexibles M-10 3/8" x 370 mm.
 Mixer with aerator, swivel spout, pull-out handshower and flexible hoses M-10 3/8" x 370 mm.

	Ref.	€		Inclus Includes
	98180	164,00	8	



Accessoires de cuisine Kitchen accessories

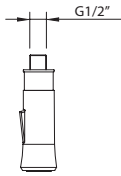

DOUCHETTE | Dishwashing pull-out

98759: pour, for: 98757 - 98764 - 99440
99441 - 99443 - 99444 - 60142 - 60729

99658: pour, for: 99445 (Mate)

ABS



Ref.	€	Q
98759	31,00	50
99658	31,00	50

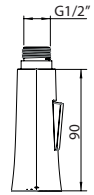

DOUCHETTE | Dishwashing pull-out

60314: pour, for: 99733-99735

99657: pour, for: 99442

ABS



Ref.	€	Q
60314	31,00	-
99657	31,00	50

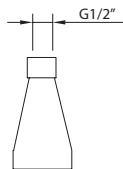

DOUCHETTE | Dishwashing pull-out

Pour, for: 96755 - 97804

ABS



Ref.	€	Q
97364	31,00	50

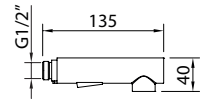

DOUCHETTE | Dishwashing pull-out

Pour, for: 98689

ABS



Ref.	€	Q
99174	31,00	-

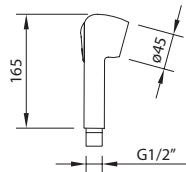

DOUCHETTE | Pull-out handshower for sink mixer

Pour évier / Pull-out handshower for sink mixer:
97069 - 98552 - 98180

ABS



Ref.	€	Q
90794	18,00	50

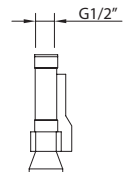

DOUCHETTE | Dishwashing pull-out

Pour, for: 96175 - 96176

Métallique / Metallic



Ref.	€	Q
96273	93,00	50

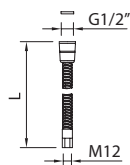

NYLON FLEXIBLE Nylon flexible



Pour/To Artic 96755

Para/To/Pour Artic 98689

Ref.	€	Q
98006	11,00	1
99173	16,00	1

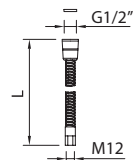

FLEXIBLE Flexible

Flexible pour évier avec douchette extractible
Flexible for pull-out mixer. Stainless steel



Pour/To Artic 97101, 96771, 96365, 96175,96176

Ref.	€	Q
96117	14,00	1
96464	11,00	1

99444
CHEF 5
Mitigeur évier douchette
Sink mixer



Éviers Classique *Sink mixers*

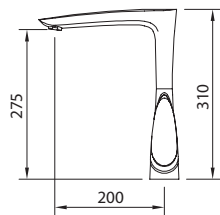

AUDE 275 mm

MITIGEUR ÉVIER
Sink mixer

Mitigeur évier bec orientable, aérateur, raccords flexibles M-10 3/8" x 370 mm.
Mixer with aerator, swivel cast spout, flexible hoses M-10 3/8" x 370 mm.

	Ref.	€	📦
	97815	295,00	8

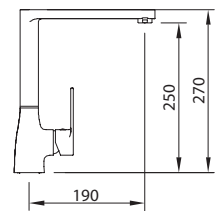

ARTIC xtreme 250 mm

MITIGEUR ÉVIER
Sink mixer

Mitigeur évier bec orientable, aérateur, raccords flexibles M-10 3/8" x 370 mm.
Mixer with aerator, swivel cast spout, flexible hoses M-10 3/8" x 370 mm.

	Ref.	€	📦
	98694	166,00	8



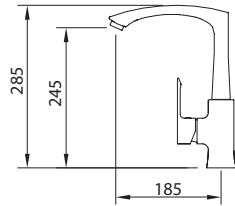

AGORA **elegance** 245 mm

MITIGEUR ÉVIER
Sink mixer

Mitigeur évier bec orientable, aérateur orientable, raccords flexibles M-10 3/8" x 370 mm.
Mixer with orientable aerator, swivel cast spout, flexible hoses M-10 3/8" x 370 mm.

	Ref.	€	☐
	98684	169,00	8

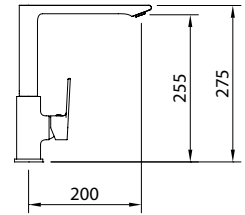

AGORA **xtreme** 255 mm

MITIGEUR ÉVIER
Sink mixer

Mitigeur évier bec orientable, aérateur, raccords flexibles M-10 3/8" x 420 mm.
Mixer with aerator, swivel cast spout, flexible hoses M-10 3/8" x 420 mm.

	Ref.	€	☐
	60113	169,00	-

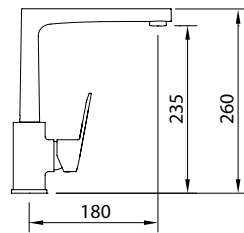

START **xtreme** 235 mm

MITIGEUR ÉVIER
Sink mixer

Mitigeur évier bec orientable, aérateur, raccords flexibles M-10 3/8" x 370 mm.
Mixer with aerator, swivel cast spout, flexible hoses M-10 3/8" x 370 mm.

	Ref.	€	☐
	60198	100,00	8

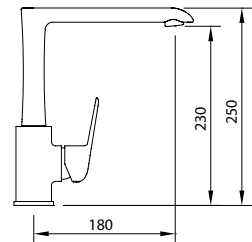

START **elegance** 230 mm

MITIGEUR ÉVIER
Sink mixer

Mitigeur évier bec orientable, aérateur, raccords flexibles M-10 3/8" x 370 mm.
Mixer, aerator, swivel spout, flexible hoses M-10 3/8" x 370 mm.

	Ref.	€	☐
	60184	106,00	8



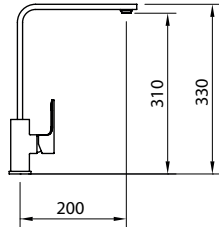

SAONA SLIM

MITIGEUR ÉVIER
Sink mixer

Mitigeur évier bec orientable, aérateur, raccords flexibles M-10 3/8" x 370 mm.
Mixer with aerator, swivel spout, flexible hoses M-10 3/8" x 370 mm.

	Ref.	€	📦
	60128	177,00	8

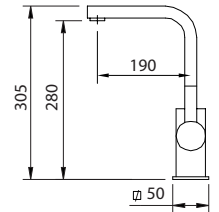

BIMINI

MITIGEUR ÉVIER
Sink mixer

Mitigeur évier bec orientable, aérateur, raccords flexibles M-10 3/8" x 370 mm.
Mixer with aerator, swivel tube spout, flexible hoses M-10 3/8" x 370 mm.

	Ref.	€	📦
	97046	233,00	8

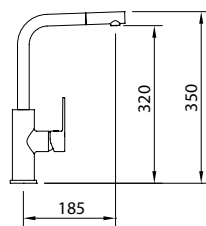

ARTIC xtreme 320 mm

MITIGEUR ÉVIER
Sink mixer

Mitigeur évier bec orientable et rotatif, aérateur, raccords flexibles M-10 3/8" x 370 mm.
Mixer with aerator, swivel cast spout, flexible hoses M-10 3/8" x 370 mm.

	Ref.	€	📦
	99108	155,00	4

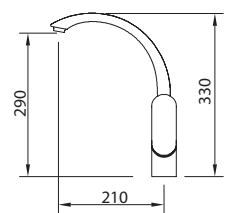

SELENE

MITIGEUR ÉVIER
Sink mixer

Mitigeur évier bec orientable, aérateur, raccords flexibles M-10 3/8" x 370 mm.
Mixer with aerator, swivel cast spout, flexible hoses M-10 3/8" x 370 mm.

	Ref.	€	📦
	98014	270,00	8



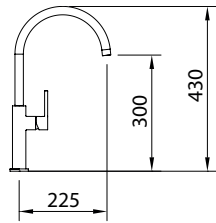

CHEF ESSENTIAL SLIM

MITIGEUR ÉVIER DOUCHETTE
Sink mixer

Évier à bec orientable, ressort de guidage renforcé. Livré avec raccords flexibles M-10 3/8" x 370 mm.
Mixer with aerator, swivel spout, flexible hoses M-10 3/8" x 370 mm.

Ref.	€	📦
60141	160,00	4

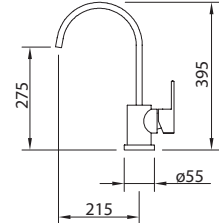

ARTIC urban

MITIGEUR ÉVIER
Sink mixer

Mitigeur évier bec orientable, aérateur, raccords flexibles M-10 3/8" x 420 mm.
Mixer with aerator, swivel tube spout, flexible hoses M-10 3/8" x 420 mm.

Ref.	€	📦
98107	166,00	5

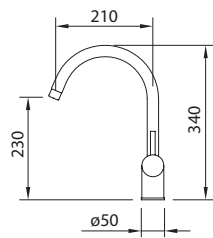

CAIMAN elegance

MITIGEUR ÉVIER
Sink mixer

Mitigeur évier bec orientable, aérateur, raccords flexibles M-10 3/8" x 370 mm.
Mixer with aerator, swivel tube spout, flexible hoses M-10 3/8" x 370 mm.

Ref.	€	📦
97086	168,00	8

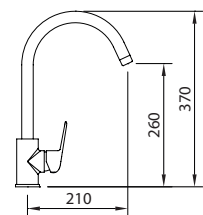

START elegance

MITIGEUR ÉVIER
Sink mixer

Mitigeur évier bec orientable, aérateur, raccords flexibles M-10 3/8" x 370 mm.
Mixer, aerator, swivel tube spout, flexible hoses M-10 3/8" x 370 mm.

Ref.	€	📦
60183	87,00	8



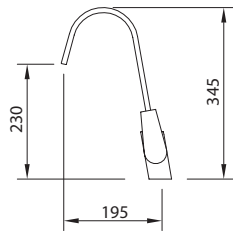

PAULA

MITIGEUR ÉVIER
Sink mixer

Mitigeur évier bec orientable, brise-jet, raccords flexibles M-10 3/8" x 370 mm.
Mixer with water breaker, swivel tube spout, flexible hoses M-10 3/8" x 370 mm.

	Ref.	€	📦
	98201	177,00	8

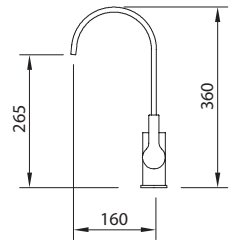

CAIMAN xtreme

MITIGEUR ÉVIER
Sink mixer

Mitigeur évier bec orientable, aérateur, raccords flexibles M-10 3/8" x 370 mm.
Mixer with aerator, swivel spout, flexible hoses M-10 3/8" x 370 mm.

	Ref.	€	📦
	98190	155,00	8

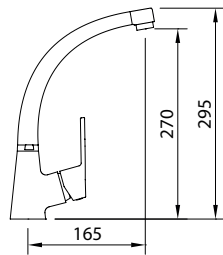

S12 xtreme

MITIGEUR ÉVIER / Sink mixer

Mitigeur évier bec orientable, aérateur, raccords flexibles M-10 3/8" x 370 mm.
Mixer with aerator, swivel tube spout, flexible hoses M-10 3/8" x 370 mm.

Cartouche / Cartridge



	Ref.	€	📦
	99833	75,00	12



Cartouche / Cartridge



	99265	79,00	12
--	-------	-------	----



98201
PAULA
Mitigeur évier
Sink Mixer

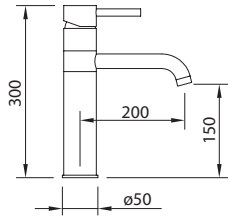

CAIMAN *elegance*

MITIGEUR ÉVIER
Sink mixer

Mitigeur évier bec orientable, aérateur, raccords flexibles M-10 3/8" x 600 mm.
Mixer, aerator swivel spout, flexible hoses M-10 3/8" x 600 mm.

	Ref.	€	
	60161	155,00	20

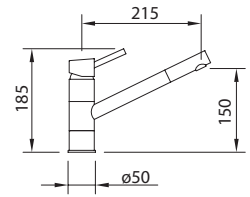

CAIMAN *urban* 150 mmm

MITIGEUR ÉVIER
Sink mixer

Mitigeur évier bec orientable, aérateur, raccords flexibles M-10 3/8" x 370 mm.
Mixer, aerator swivel spout, flexible hoses M-10 3/8" x 370 mm.

	Ref.	€	
	92603	131,00	8

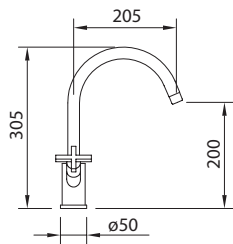

WITH2 *morea* 200 mm

MITIGEUR ÉVIER
Sink mixer

Mélangeur évier, bec orientabl, eaérateur, raccords flexibles M-10 3/8" x 370 mm.
Mixer with aerator, swivel tube spout, flexible hoses M-10 3/8" x 370 mm.

	Ref.	€	
	97005	152,00	8

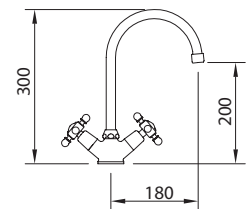

WITH2 *antigona* 200 mm

MITIGEUR ÉVIER
Sink mixer

Mélangeur évier, bec orientabl, eaérateur, raccords flexibles M-10 3/8" x 370 mm.
Mixer with aerator, swivel tube spout, flexible hoses M-10 3/8" x 370 mm.

	Ref.	€	
	92049	65,00	8



Éviers Façon Inox *Sink mixers*



Inox | Stainless steel



MATT Fini mat.
Matt finish.

CHEF 5 MATT

MITIGEUR ÉVIER Sink mixer

Évier à bec orientable, ressort de guidage renforcé, douchette avec poussoir pré-lavage. Livré avec raccords flexibles M-10 3/8" x 370 mm.
Mixer with aerator, swivel spout, handset and flexible hoses M-10 3/8" x 370 mm.

Ref.	€	📦
99445	355,00	4

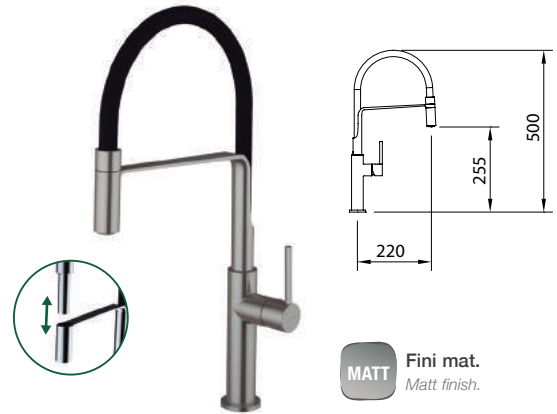

MATT Fini mat.
Matt finish.

CHEF SLIM MAT

MITIGEUR ÉVIER Sink mixer

Évier à bec orientable. Livré avec raccords flexibles M-10 3/8" x 370 mm.
Mixer with aerator, handset and flexible hoses M-10 3/8" x 370 mm.

Ref.	€	📦
60144	212,00	4



INOX Fini inox.
Stainless finish.

CURVE - Fini inox

MITIGEUR ÉVIER Sink mixer

Mitigeur évier bec orientable, aérateur, raccords flexibles M-10 3/8" x 420 mm.
Mixer with aerator, swivel spout, flexible hoses M-10 3/8" x 420 mm.

Ref.	€	📦
99850	145,00	10

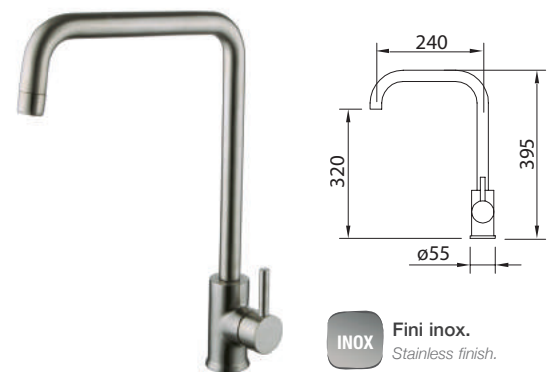

INOX Fini inox.
Stainless finish.

RIGHT - Fini inox

MITIGEUR ÉVIER Sink mixer

Mitigeur évier bec orientable, aérateur, raccords flexibles M-10 3/8" x 420 mm.
Mixer with aerator, swivel spout, flexible hoses M-10 3/8" x 420 mm.

Ref.	€	📦
99851	145,00	10



PVD
Physical
Vapor
Deposition

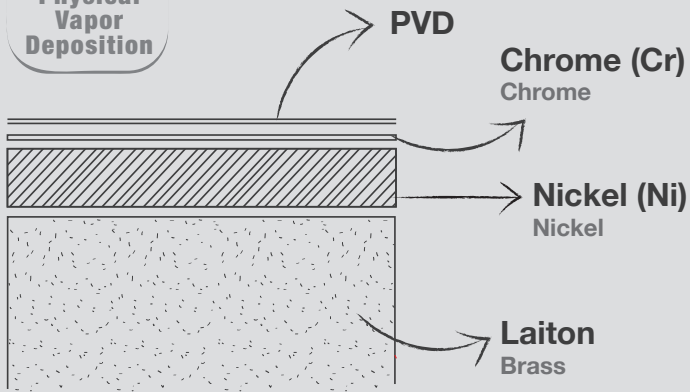

Technologie PVD. Physical Vapor Deposition

Processus de revêtement de nitrure de titane sous vide (PVD) créant une union moléculaire avec la pièce à couvrir.

Le revêtement se condense, formant une pellicule qui donne à la surface une grande résistance à l'usure, aux rayures, aux coups et à la corrosion.

Coating process where titanium nitride is vaporized and transported to an empty form with a molecular union to cover the piece. The coating is condensed, forming a film to create a surface with high resistance, postponing wear, scratches, blows and corrosion.

Pour / For:
Chef 5 MATT, 99445



99850 CURVE INOX
Mitigeur évier
Sink Mixer

Éviers Rabattables *Sink mixers*



Rabattable | Folding spout

Une robinetterie rabattable pour les éviers situés devant une fenêtre.

Avec ces robinets vous pourrez ouvrir la fenêtre de votre cuisine sans obstacles.

Les robinets s'inclinent complètement, sans gêner l'ouverture de la fenêtre. Ils se rabattent avec un simple geste, et disposent de plusieurs points de fixation. Ils retournent facilement à leur position verticale.

Practical solution for sinks below a window.

With this kitchen tap you can open the window without obstacles.

Practical solution for sink mixers below a window. With this kitchen tap you can open the window without any obstacle. The tap totally bends softly allowing to open the window without any inconvenience.

You can return the spout to its original position easily.

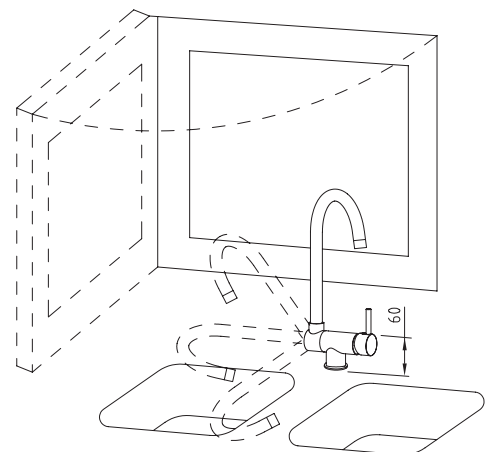



MITIGEUR ÉVIER 3 VOIES À BEC RABATTABLE ET ORIENTABLE POUR ÉQUIPEMENT DE QUALITÉ DE L'EAU
3 way sink mixer for water quality equipment with folding spout

Mitigeur évier à bec rabattable et orientable avec sortie pour eau purifiée, aérateur/buse intégré, raccords flexibles M-10 3/8" x 420 mm. Water quality sink mixer with folding spout with 2 outflows, flexible hoses M-10 3/8" x 420 mm.

Ref.	€	
60731	207,00	-

Inclus Includes  97399 Adaptateur tubo PE 1/4" - 7/16"-24 H. Adapter for PE 1/4" - 7/16"-24 F pipe.



VOIR LA PAGE 112
 See pag. 112



MITIGEUR ÉVIER À BEC RABATTABLE
Sink mixer with folding spout

Mitigeur évier bec rabattable, aérateur, raccords flexibles M-10 3/8" x 370 mm. Deck mounted sink mixer 180° foldingspout, aerator, swivel tube spout, flexible hoses M-10 3/8" x 370 mm.

Ref.	€	
60152	169,00	4

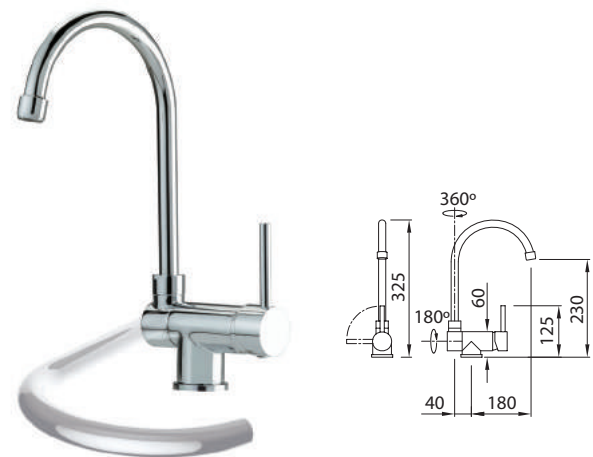

MITIGEUR ÉVIER À BEC RABATTABLE
Sink mixer with folding spout

Mitigeur évier bec rabattable, aérateur, raccords flexibles M-10 3/8" x 370 mm. Deck mounted sink mixer 180° foldingspout, aerator, swivel tube spout, flexible hoses M-10 3/8" x 370 mm.

Ref.	€	
96095	124,00	8



Éviers Eau Purifiée *Sink mixers*

Robinets d'équipement de qualité de l'eau | Water quality equipment taps

NOUVEAU MITIGEUR ÉVIER AVEC SORTIE EAU PURIFIÉE

New drinking water sink mixer



Dispositif aimanté pour
maintenir la douche

Magnet system to grab the dishwashing pull-out



Nous maintenons le **design** des mitigeurs évier **Chef**, mais en le rendant plus fonctionnel grâce à ses **3 voies**.

We maintain the Chef design, but more useful with its 3 ways

CHEF WT 19
Ref. 60729

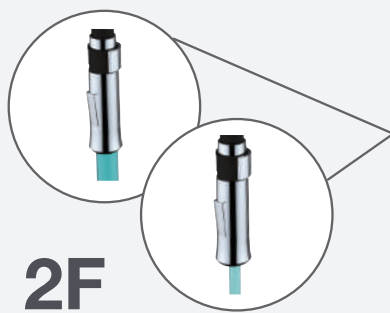

2F

Sortie d'eau mitigée
Mixed water outlet



Sortie d'eau purifiée
Filtered water outlet

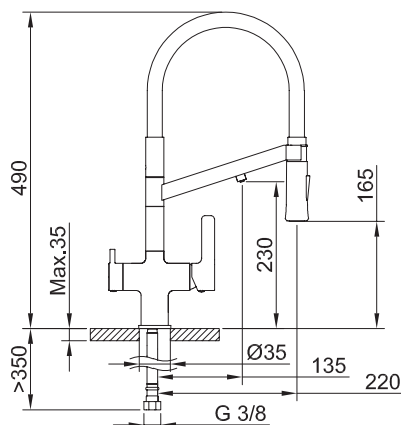

CHEF WT 19

MITIGEUR ÉVIER SEMIPROFSSIONNEL À 3 VOIES POUR ÉQUIPEMENT DE QUALITÉ DE L'EAU
3 way semiprofessional sink mixer for water quality equipment

Mitigeur évier pour eau purifiée, aérateur/buse intégré, raccords flexibles M-10 3/8" x 420 mm.
Water quality sink mixer with 2 outflows, flexible hoses M-10 3/8" x 420 mm.

Ref.	€	
60729	320,00	-

Inclus
Includes



97399

Adaptateur tubo PE 1/4" - 7/16"-24 H.
Adapter for PE 1/4" - 7/16"-24 F pipe.



60733 99656 97698 97688 98759

Disponible en Septembre 2019
Available in September 2019

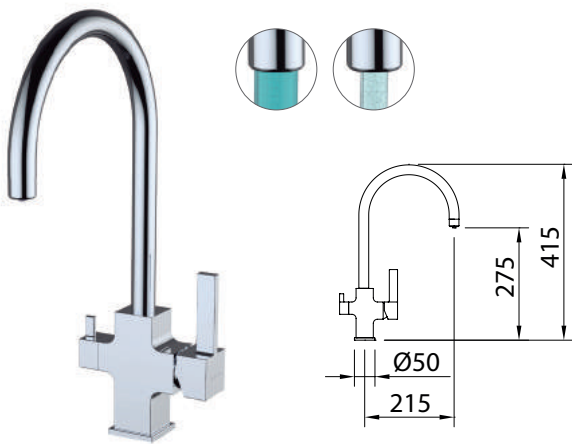

SQUARE

MITIGEUR ÉVIER 3 VOIES POUR ÉQUIPEMENT DE QUALITÉ DE L'EAU
3 way sink mixer for water quality equipment

Mitigeur évier pour eau purifiée, aérateur/buse intégré, raccords flexibles M-10 3/8" x 370 mm.
 Water quality sink mixer with 2 outflows, flexible hoses M-10 3/8" x 370 mm.

Ref.	€	📦
60151	207,00	4



Adaptateur tubo PE 1/4" - 7/16"-24 H.
 Adapter for PE 1/4" - 7/16"-24 F pipe.

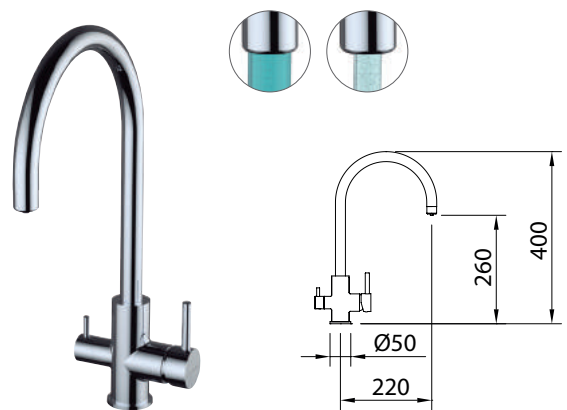

ROUND

MITIGEUR ÉVIER 3 VOIES POUR ÉQUIPEMENT DE QUALITÉ DE L'EAU
3 way sink mixer for water quality equipment

Mitigeur évier pour eau purifiée, aérateur/buse intégré, raccords flexibles M-10 3/8" x 370 mm.
 Water quality sink mixer with 2 outflows, flexible hoses M-10 3/8" x 370 mm.

Ref.	€	📦
60150	179,00	4



Adaptateur tubo PE 1/4" - 7/16"-24 H.
 Adapter for PE 1/4" - 7/16"-24 F pipe.



95249 95251 99656 97688 60153 97698



95248 95250 99656 97688 60153 97698



NOUVEAU MITIGEUR À BEC RABATTABLE ET ORIENTABLE AVEC SORTIE POUR EAU PURIFIÉE

*New drinking water sink mixer with
folding spout*

Eau du réseau et eau
purifiée depuis une seule
manette (Voir Fig.1 et 2)

*Mixed water and filtered water on the
same handle (See Fig.1 and 2)*



RABATTEBLE FS 19
Ref. 60731

QUORE

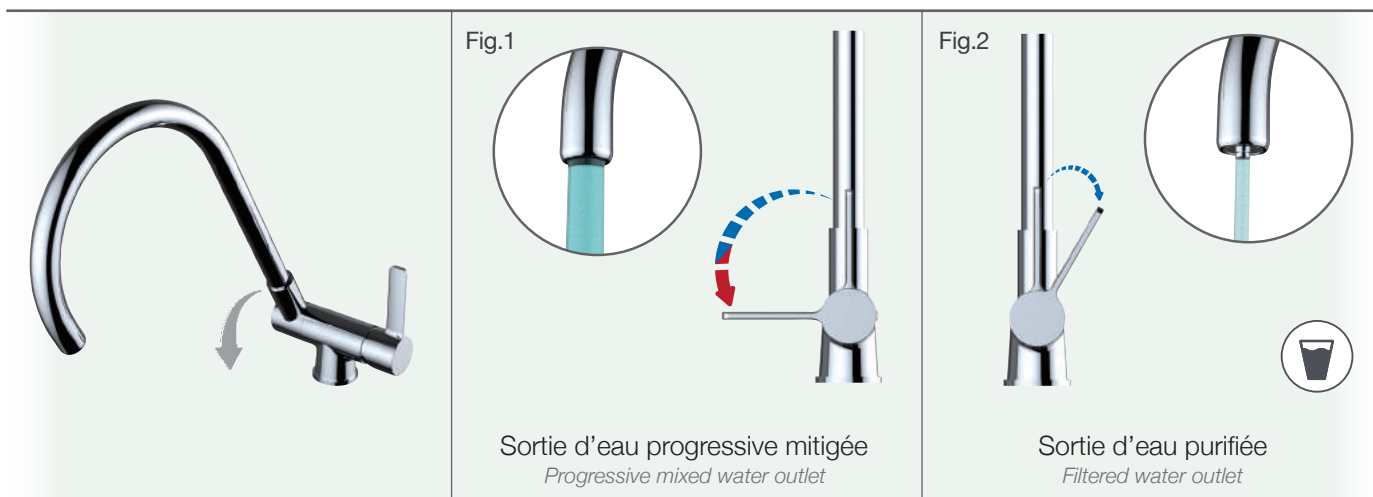
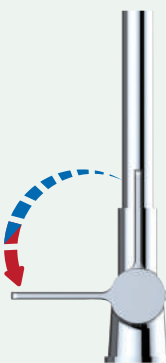
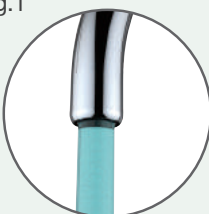

Fig.1



Sortie d'eau progressive mitigée
Progressive mixed water outlet

Fig.2



Sortie d'eau purifiée
Filtered water outlet

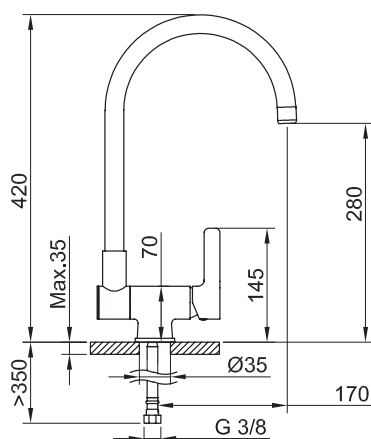

RABATTEBLE FS 19

MITIGEUR ÉVIER 3 VOIES À BEC RABATTABLE ET ORIENTABLE POUR ÉQUIPEMENT DE QUALITÉ DE L'EAU 3 way sink mixer for water quality equipment with folding spout

Mitigeur évier à bec rabattable et orientable avec sortie pour eau purifiée, aérateur/buse intégré, raccords flexibles M-10 3/8" x 420 mm.

Water quality sink mixer with folding spout with 2 outflows, flexible hoses M-10 3/8" x 420 mm.

Ref.	€	
60731	207,00	-

Disponible en Septembre 2019
Available in September 2019

Inclus Includes 97399 Adaptateur tubo PE 1/4" - 7/16"-24 H.
Adapter for PE 1/4" - 7/16"-24 F pipe.



60733 60153 60732 97688

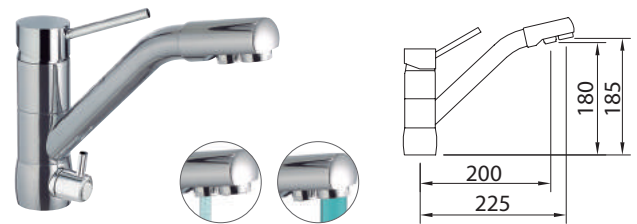
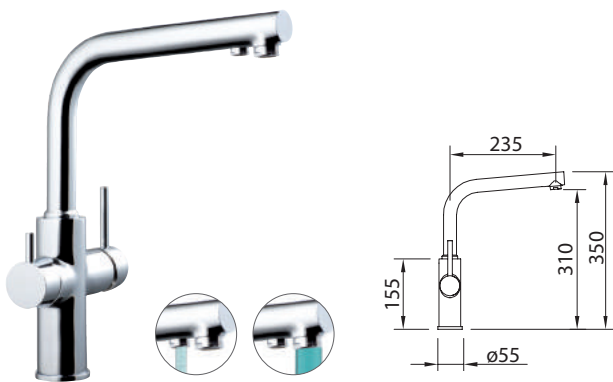

MITIGEUR ÉVIER 3 VOIES POUR ÉQUIPEMENT DE QUALITÉ DE L'EAU
3 way sink mixer for water quality equipment

Mitigeur évier pour eau purifiée, aérateur intégré, raccords flexibles M-10 3/8" x 370 mm.
 Water quality sink mixer with 2 outflows, flexible hoses M-10 3/8" x 370 mm.

MITIGEUR ÉVIER 3 VOIES POUR ÉQUIPEMENT DE QUALITÉ DE L'EAU
3 way sink mixer for water quality equipment

Mitigeur évier pour eau purifiée, aérateur, raccords flexibles M-10 3/8" x 370 mm.
 Water quality sink mixer with 2 outflows, flexible hoses M-10 3/8" x 370 mm.

Ref.	€	📦
97806	189,00	4

Inclus / Includes  97399 Adaptateur tubo PE 1/4" - 7/16"-24 H. / Adapter for PE 1/4" - 7/16"-24 F pipe.



- 95145
- 98631
- 97371
- 97698
- 97688
- 99737
- 90025 ø24
- 96202 ø20

Ref.	€	📦
98760	207,00	8

Inclus / Includes  97399 Adaptateur tubo PE 1/4" - 7/16"-24 H. / Adapter for PE 1/4" - 7/16"-24 F pipe.



- 98778
- 98632
- 97370
- 97697
- 90025
- 96202



NOTES

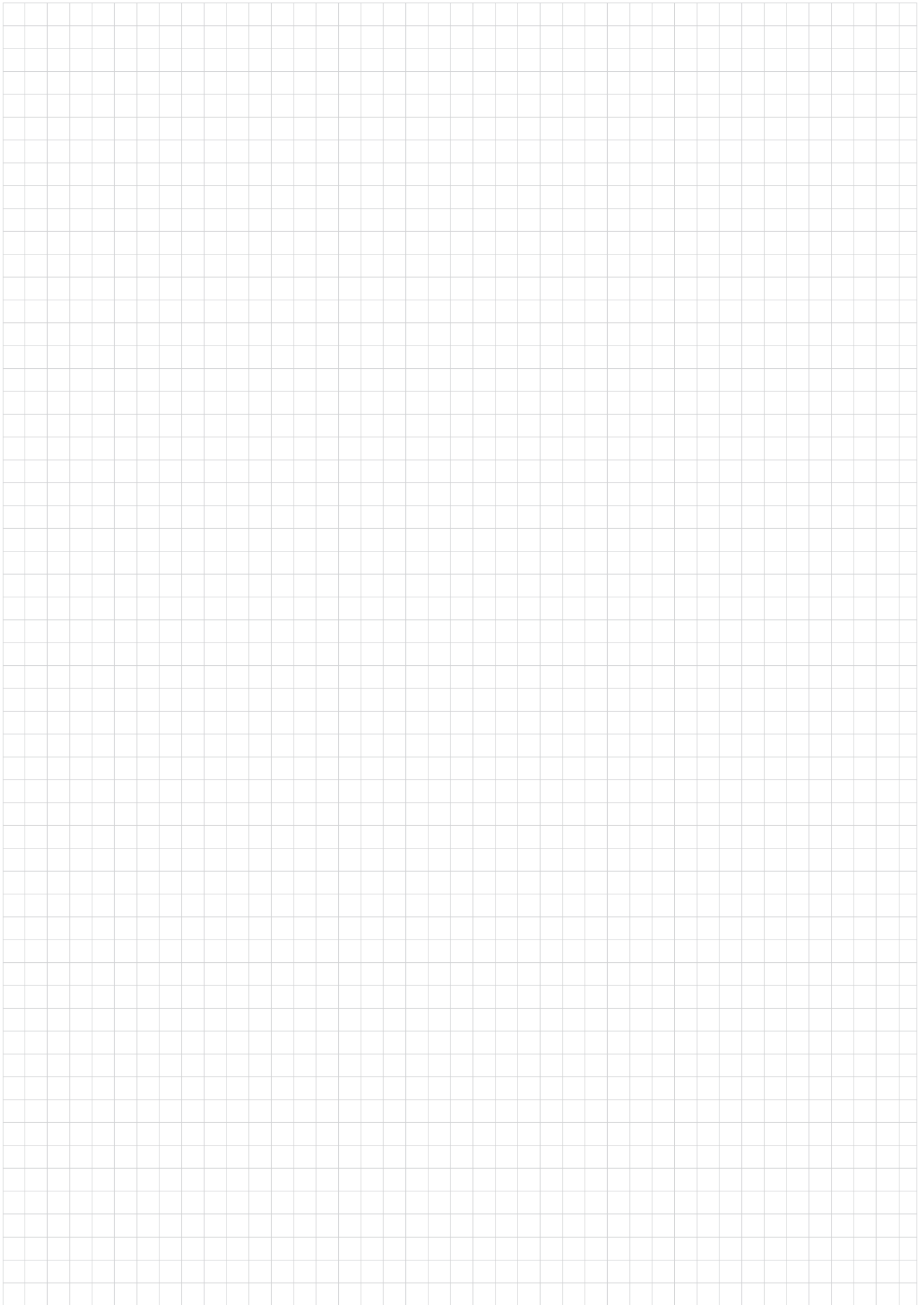

NOTES

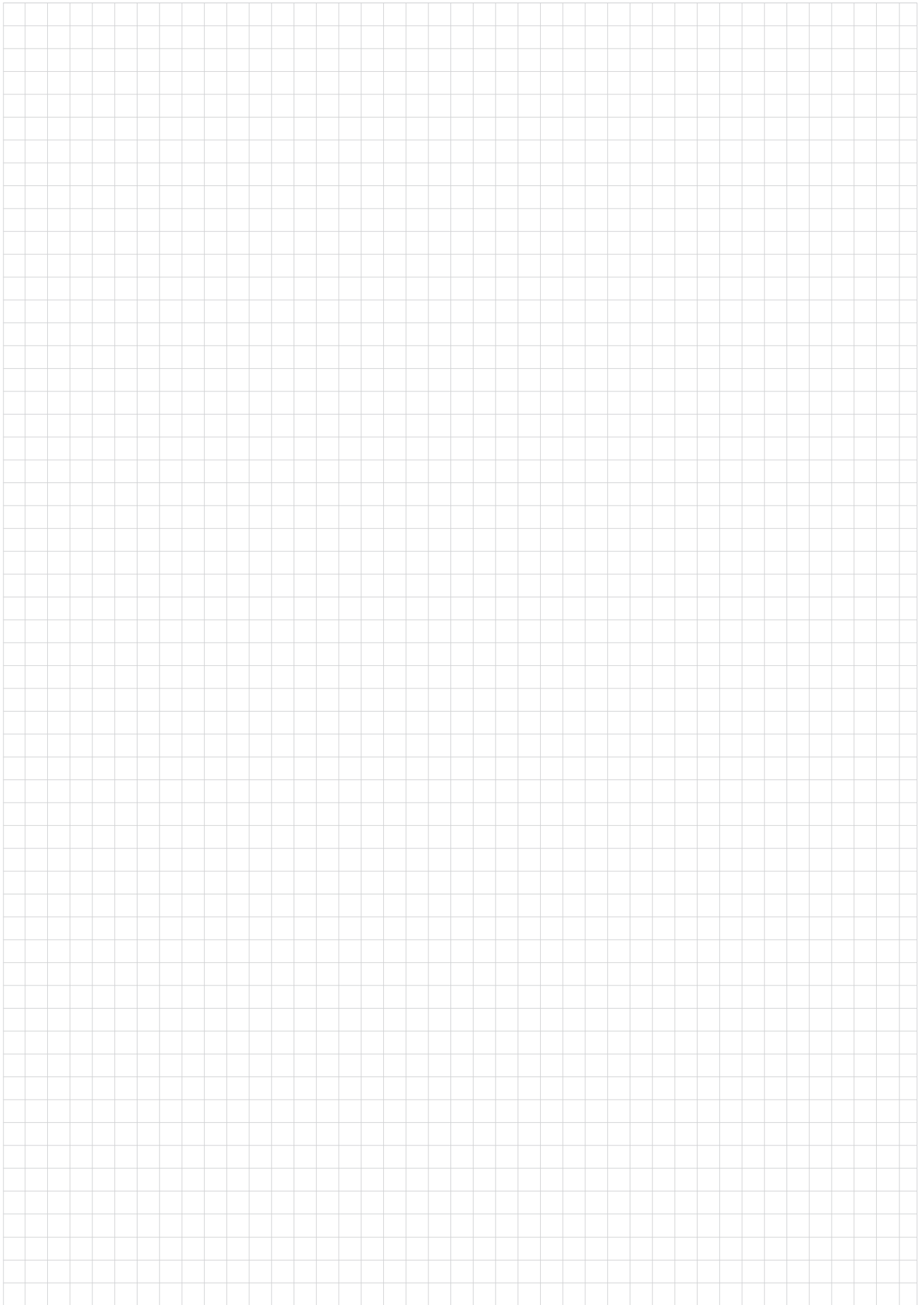

NOTES

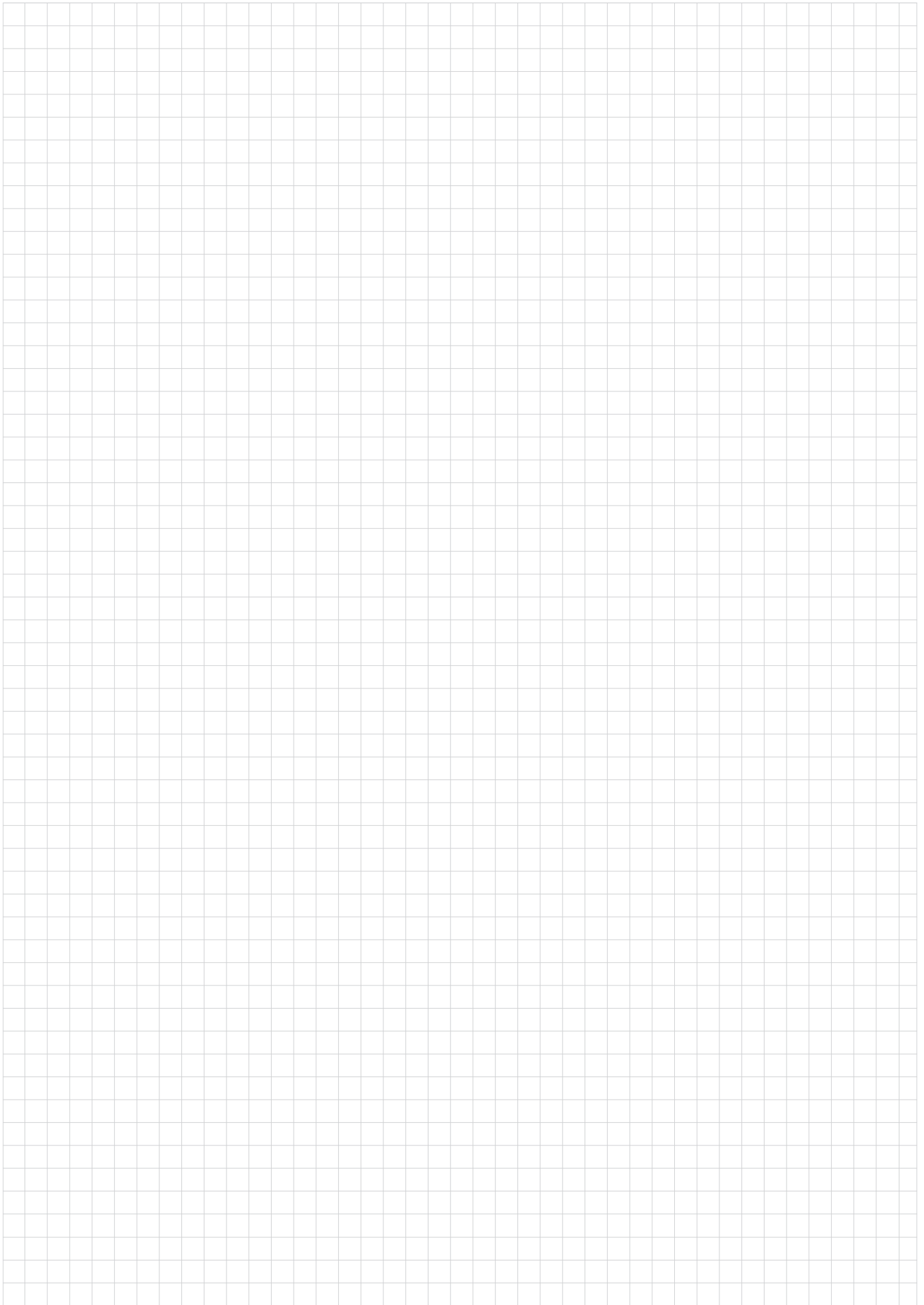

Chaque design,
une émotion

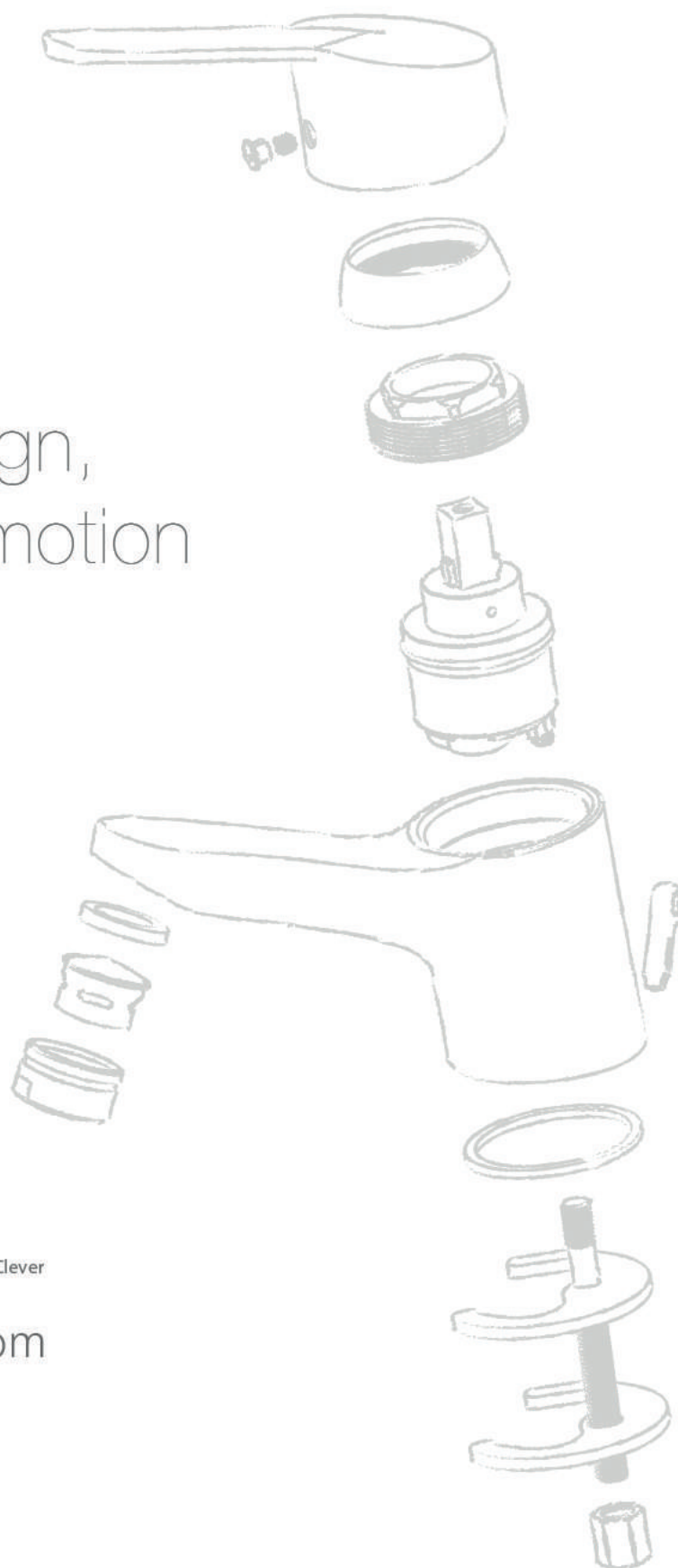

 @CleverGriferia  GriferiaClever  GriferiaClever

www.robinetterieclever.com

Standard Hidráulica S.A.U.

Avenida La Ferrería, 73-75 · Pol. Ind. La Ferrería
08110 - Montcada i Reixac · Barcelona (Spain)
Tel. +34 93 564 10 94 · info@griferiaclever.com

SEDE MADRID

C. Sierra Morena, 15
28320 Pinto (Spain)
+34 91 643 18 86 / +34 91 692 05 53

clever

R O B I N E T T E R I E



Professionnel

— COLLECTION 2019 —

clever

R O B I N E T T E R I E

La marque **Clever** est née en 1998 au sein de **Standard Hidráulica S.A.U.**, une entreprise fondée à Barcelone en 1975 et reconnue comme l'un des principaux fabricants de **robinetterie** pour **la cuisine, la salle de bain et les collectivités** en Espagne. La **qualité**, le **service**, l'**innovation** et l'**excellence de nos designs**, associés à l'intégration constante des **nouvelles technologies** et le **suivi attentif de notre clientèle** sont les fondements de notre philosophie d'entreprise.

Clever taps was launched in 1998 by Standard Hidraulica, company founded in 1975, well known as one of the most important taps, mixers and showers manufacturers in Spain. Our company philosophy is based on quality, service, innovation, exquisite design and technology investigation.

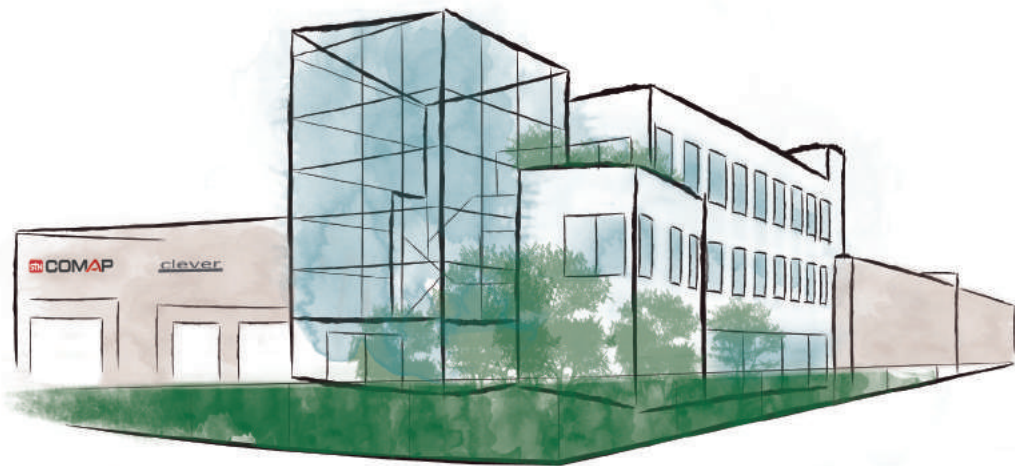

Index des références

Item directory

SHOWROOM ET PROFESSIONNEL

Ref.	€	Pág.
40010	13,00	2_61
40011	13,00	2_61
60100	129,00	1_22
60101	137,00	1_22
60102	145,00	1_22
60103	173,00	1_22
60106	129,00	1_23
60107	137,00	1_23
60108	145,00	1_23
60109	182,00	1_23
60110	161,00	1_23
60111	151,00	1_23
60112	130,00	1_23
60113	169,00	1_23
60113	169,00	1_101
60115	147,00	1_16
60116	155,00	1_16
60117	163,00	1_16
60118	199,00	1_16
60121	147,00	1_17
60122	155,00	1_17
60123	163,00	1_17
60124	238,00	1_17
60125	207,00	1_17
60126	202,00	1_17
60127	171,00	1_17
60128	177,00	1_17
60128	177,00	1_102
60131	342,00	1_51
60132	311,00	1_51
60133	290,00	1_51
60134	259,00	1_51
60135	512,00	1_56
60141	160,00	1_103
60142	269,00	1_93
60143	191,00	1_94
60144	212,00	1_94
60144	212,00	1_106
60145	212,00	1_9
60145	212,00	1_95
60146	212,00	1_7
60146	212,00	1_95
60147	228,00	1_9
60147	228,00	1_95
60148	228,00	1_7
60148	228,00	1_95
60150	179,00	1_111
60151	207,00	1_111
60152	169,00	1_106
60154	383,00	1_50
60156	76,00	1_81
60157	50,00	1_82
60158	43,00	1_83
60159	50,00	1_85
60160	35,00	1_86
60161	155,00	1_29
60161	155,00	1_105
60170	69,00	1_32
60171	77,00	1_32
60172	85,00	1_32
60173	80,00	1_32
60174	88,00	1_32
60175	96,00	1_32
60176	69,00	1_33
60177	77,00	1_33
60178	85,00	1_33

Ref.	€	Pág.
60179	120,00	1_33
60180	105,00	1_33
60181	98,00	1_33
60182	83,00	1_33
60183	87,00	1_35
60183	87,00	1_103
60184	106,00	1_35
60184	106,00	1_101
60185	69,00	1_36
60186	77,00	1_36
60187	85,00	1_36
60188	80,00	1_36
60189	88,00	1_36
60190	96,00	1_36
60191	69,00	1_37
60192	77,00	1_37
60193	85,00	1_37
60194	120,00	1_37
60195	105,00	1_37
60196	98,00	1_37
60197	83,00	1_37
60198	100,00	1_38
60198	100,00	1_101
60301	37,00	1_77
60302	18,00	1_66
60303	58,00	1_78
60304	29,00	1_66
60305	62,00	1_79
60306	37,00	1_77
60307	18,00	1_64
60308	507,00	1_75
60311	5,50	1_68
60314	31,00	1_98
60325	169,00	1_53
60326	154,00	1_53
60327	431,00	1_58
60328	400,00	1_58
60412	420,00	2_45
60413	389,00	2_45
60414	158,00	1_53
60415	143,00	1_53
60418	14,00	2_51
60558	12,00	2_60
60559	1,90	2_64
60563	97,00	1_81
60564	50,00	1_82
60565	43,00	1_83
60566	68,00	1_85
60567	37,00	1_87
60690	148,00	1_72
60691	121,00	1_72
60694	295,00	2_48
60696	23,00	2_30
60697	35,00	2_30
60698	26,00	2_30
60701	16,00	2_60
60702	16,00	2_60
60704	144,00	1_8
60705	144,00	1_6
60706	188,00	1_8
60707	188,00	1_6
60712	95,00	1_8
60713	95,00	1_6
60716	63,00	2_14
60717	71,00	2_14
60718	79,00	2_14

Ref.	€	Pág.
60729	320,00	1_110
60731	207,00	1_109
60731	207,00	1_112
60734	58,00	2_23
60735	45,00	2_23
60736	48,00	2_23
60739	330,00	2_24
60740	290,00	2_24
60741	105,00	2_26
60742	69,00	2_27
60745	227,00	2_41
60746	98,00	2_36
60747	124,00	2_38
60748	175,00	2_40
60761	352,00	1_50
60791	592,00	1_7
90011	4,35	1_68
90703	7,00	1_68
90704	9,00	1_68
90755	23,00	2_61
90758	19,00	1_67
90794	18,00	1_98
90796	13,00	1_67
92049	65,00	1_105
92603	131,00	1_105
92801	45,00	2_22
92901	5,50	2_60
94474	72,00	1_42
94475	72,00	1_43
94476	126,00	1_43
94477	81,00	1_43
94694	61,00	2_33
95040	2,75	2_62
95042	7,50	2_63
95043	4,00	2_62
95044	2,25	2_63
95045	2,25	2_63
95046	2,25	2_63
95051	13,00	2_63
95540	97,00	2_52
95663	22,00	2_54
95664	57,00	2_56
95665	54,00	2_56
95666	54,00	2_52-2_56
95667	538,00	2_54
95668	33,00	2_54
95669	33,00	2_54
95670	43,00	2_54
95671	72,00	2_56
95717	33,00	2_52
95749	38,00	2_54
95753	181,00	2_53
95754	67,00	2_53
95755	78,00	2_53
95756	41,00	2_54
95806	54,00	2_56
95821	186,00	2_52
95824	54,00	2_54
95828	93,00	2_55
95829	54,00	2_52
95832	93,00	2_55
95837	52,00	2_55
95838	93,00	2_55
95839	41,00	2_55
95840	43,00	2_55
96095	124,00	1_109

Index des références

Item directory

SHOWROOM ET PROFESSIONNEL

Ref.	€	Pág.
96097	27,00	2_31
96114	17,00	1_79
96117	14,00	1_98
96118	191,00	2_64
96120	40,00	2_63
96122	15,00	1_68
96127	55,00	2_22
96128	42,00	2_22
96133	17,00	2_31
96134	32,00	2_31
96136	25,00	2_29
96141	26,00	1_79
96141	26,00	2_42
96152	66,00	2_22
96153	41,00	2_42
96154	455,00	1_45
96154	455,00	1_63
96173	52,00	2_61
96174	43,00	2_61
96238	6,00	2_62
96243	2,75	2_62
96254	18,00	2_60
96255	18,00	2_60
96264	21,00	1_68
96264	21,00	2_64
96267	6,50	2_62
96273	93,00	1_98
96292	43,00	2_61
96299	9,50	2_63
96365	538,00	1_91
96413	8,00	1_68
96437	87,00	1_77
96458	12,00	1_68
96464	11,00	1_98
96545	80,00	1_42
96546	80,00	1_43
96746	576,00	1_44
96746	576,00	1_59
96747	500,00	1_45
96786	22,00	1_67
96942	8,50	1_68
97001	152,00	1_46
97002	152,00	1_47
97003	243,00	1_47
97005	152,00	1_47-1_105
97006	232,00	1_46
97007	232,00	1_47
97018	1113,00	1_48
97020	702,00	1_48
97041	243,00	1_14
97042	243,00	1_14
97043	243,00	1_15
97044	394,00	1_15
97045	348,00	1_15
97046	233,00	1_15
97046	233,00	1_102
97061	142,00	1_28
97062	142,00	1_29
97065	188,00	1_28
97069	199,00	1_29
97069	199,00	1_97
97086	168,00	1_29
97086	168,00	1_103
97101	538,00	1_91
97106	17,00	2_61
97107	17,00	2_61

Ref.	€	Pág.
97112	28,00	1_68
97113	19,00	1_68
97114	16,00	1_68
97125	168,00	1_46
97126	168,00	1_47
97127	248,00	1_46
97131	259,00	1_14
97132	259,00	1_14
97133	259,00	1_15
97135	158,00	1_28
97136	158,00	1_29
97142	16,00	1_67
97148	26,00	2_43
97276	225,00	1_75
97363	1,25	2_63
97364	31,00	1_98
97368	41,00	2_42
97395	18,00	2_60
97396	3,75	2_62
97397	6,00	2_62
97399	7,00	2_63
97670	9,50	1_68
97688	2,25	2_62
97740	28,00	2_29
97800	86,00	2_28
97801	114,00	2_28
97802	64,00	2_28
97803	59,00	2_28
97804	219,00	1_96
97806	189,00	1_113
97809	17,00	2_29
97810	243,00	1_10
97811	295,00	1_10
97812	243,00	1_11
97813	394,00	1_11
97814	348,00	1_11
97815	295,00	1_11
97815	295,00	1_100
97816	6,50	1_68
97825	3,75	2_62
97840	251,00	1_10
97841	259,00	1_10
97842	303,00	1_10
97843	311,00	1_10
97844	251,00	1_11
97845	259,00	1_11
97846	363,00	1_11
97847	317,00	1_11
97850	251,00	1_14
97851	251,00	1_15
97852	251,00	1_14
97853	363,00	1_15
97854	317,00	1_15
97866	150,00	1_28
97868	150,00	1_29
97881	160,00	1_46
97882	160,00	1_47
97883	222,00	1_47
97885	240,00	1_46
97927	88,00	1_42
97928	88,00	1_43
97929	105,00	1_43
97930	60,00	1_43
97975	95,00	2_33
97983	21,00	1_66
97984	25,00	1_64

Ref.	€	Pág.
97985	71,00	1_71
97986	83,00	1_71
97987	71,00	1_71
97988	89,00	1_70
97989	48,00	1_73
97990	55,00	1_73
97991	46,00	1_73
97992	59,00	1_73
97994	27,00	1_64
97996	16,00	1_79
97999	64,00	2_42
98000	66,00	2_42
98001	26,00	2_43
98004	35,00	2_42
98005	21,00	2_42
98006	11,00	1_98
98009	295,00	1_12
98010	243,00	1_12
98011	243,00	1_13
98012	394,00	1_13
98013	348,00	1_13
98014	270,00	1_13
98014	270,00	1_102
98017	251,00	1_12
98018	259,00	1_12
98019	251,00	1_13
98020	259,00	1_13
98022	36,00	1_68
98102	131,00	1_26
98103	175,00	1_26
98104	131,00	1_27
98105	179,00	1_27
98106	148,00	1_27
98107	166,00	1_27
98107	166,00	1_103
98109	147,00	1_26
98110	139,00	1_26
98111	191,00	1_26
98112	183,00	1_26
98113	147,00	1_27
98114	139,00	1_27
98149	169,00	1_52
98150	363,00	1_13
98151	317,00	1_13
98175	87,00	2_8
98176	85,00	2_9
98179	158,00	2_10
98180	164,00	1_97
98180	164,00	2_10
98181	95,00	2_8
98182	103,00	2_8
98183	93,00	2_9
98184	101,00	2_9
98185	126,00	1_30
98186	173,00	1_30
98187	126,00	1_31
98188	194,00	1_31
98189	162,00	1_31
98190	155,00	1_31
98190	155,00	1_104
98191	134,00	1_30
98192	142,00	1_30
98193	181,00	1_30
98194	189,00	1_30
98195	134,00	1_31
98196	142,00	1_31

Index des références

Item directory

SHOWROOM ET PROFESSIONNEL

Ref.	€	Pág.
98197	147,00	1_18
98198	147,00	1_19
98199	220,00	1_19
98200	174,00	1_19
98201	177,00	1_19
98201	177,00	1_104
98202	155,00	1_18
98203	163,00	1_18
98204	155,00	1_19
98205	163,00	1_19
98208	5,50	1_68
98235	27,00	2_43
98236	27,00	2_43
98282	135,00	2_9
98283	104,00	2_9
98331	53,00	2_15
98334	75,00	2_16
98338	61,00	2_15
98339	69,00	2_15
98342	7,90	1_67
98343	3,31	1_68
98344	81,00	2_16
98413	217,00	1_18
98415	690,00	1_60
98426	184,00	1_42
98427	192,00	1_42
98428	200,00	1_42
98429	151,00	1_43
98440	104,00	2_43
98441	104,00	2_43
98442	52,00	2_29
98448	60,00	2_31
98449	27,00	2_31
98451	28,00	2_31
98458	27,00	2_31
98478	184,00	1_52
98497	16,00	2_62
98517	191,00	2_64
98518	44,00	1_78
98527	320,00	2_46
98539	189,00	1_19
98540	143,00	1_19
98541	158,00	1_27
98542	127,00	1_27
98543	173,00	1_31
98552	126,00	1_97
98615	92,00	2_13
98616	81,00	2_12
98617	89,00	2_12
98618	77,00	2_13
98619	85,00	2_13
98645	105,00	2_13
98646	83,00	2_13
98647	39,00	2_63
98650	14,00	1_86
98651	30,00	1_86
98652	35,00	1_86
98653	38,00	1_86
98654	87,00	1_86
98655	25,00	1_83
98656	36,00	1_83
98657	34,00	1_83
98658	53,00	1_83
98659	128,00	1_83
98666	2,75	2_62
98667	2,75	2_62

Ref.	€	Pág.
98671	595,00	2_44
98672	44,00	1_78
98673	14,00	2_60
98674	15,00	2_60
98675	18,00	2_60
98678	172,00	1_21
98679	140,00	1_21
98680	140,00	1_20
98681	140,00	1_21
98682	193,00	1_21
98683	161,00	1_21
98684	169,00	1_21
98684	169,00	1_101
98685	148,00	1_20
98686	156,00	1_20
98687	148,00	1_21
98688	156,00	1_21
98689	197,00	1_97
98690	111,00	1_24
98691	111,00	1_25
98692	158,00	1_25
98693	127,00	1_25
98694	166,00	1_25
98694	166,00	1_100
98695	119,00	1_24
98696	127,00	1_24
98697	119,00	1_25
98698	127,00	1_25
98699	137,00	1_25
98700	106,00	1_25
98703	124,00	2_34
98706	141,00	2_34
98707	141,00	2_34
98708	141,00	2_34
98709	141,00	2_34
98710	141,00	2_34
98711	82,00	2_36-2_38
98714	98,00	2_36
98715	98,00	2_37
98716	98,00	2_36
98717	98,00	2_37
98718	98,00	2_37
98719	98,00	2_37
98720	98,00	2_36
98721	98,00	2_37
98723	98,00	2_37
98724	93,00	2_37
98725	93,00	2_37
98729	124,00	2_38
98730	124,00	2_39
98731	124,00	2_38
98732	124,00	2_39
98733	124,00	2_39
98734	124,00	2_39
98735	124,00	2_38
98736	124,00	2_39
98738	124,00	2_39
98739	110,00	2_39
98740	110,00	2_39
98742	113,00	2_40-2_41
98745	175,00	2_40
98746	175,00	2_40
98747	175,00	2_40
98748	175,00	2_40
98749	175,00	2_40
98750	227,00	2_41

Ref.	€	Pág.
98751	3,75	2_63
98752	3,75	2_63
98753	121,00	2_9
98755	93,00	2_13
98757	305,00	1_93
98759	31,00	1_98
98760	207,00	1_113
98764	290,00	1_93
98783	183,00	1_20
98784	152,00	1_24
98798	34,00	2_29
98799	36,00	2_29
98800	59,00	2_14
98801	91,00	2_15
98802	81,00	2_15
98803	79,00	2_16
98804	85,00	2_16
98805	67,00	2_14
98806	75,00	2_14
98807	101,00	2_15
98808	91,00	2_15
98822	203,00	1_53
98823	218,00	1_52
98824	33,00	1_83
98825	27,00	1_86
98826	48,00	1_87
98827	43,00	1_87
98850	499,00	2_46
98880	23,00	1_68
98881	22,00	2_50
98884	18,00	1_66
98885	18,00	2_50
98886	64,00	2_50
98888	26,00	1_66
98892	139,00	1_78
98895	67,00	2_33
98896	45,00	2_33
98897	50,00	2_33
98899	99,00	1_76
98909	340,00	1_62
98913	153,00	2_10
98928	188,00	1_53
98929	203,00	1_52
98986	2,75	2_62
98994	3,63	2_62
98996	124,00	2_64
98997	15,00	1_68
98997	15,00	2_64
98998	13,00	2_62
99108	155,00	1_102
99121	155,00	2_9
99122	124,00	2_9
99127	15,00	2_60
99128	10,00	1_68
99129	14,00	1_67
99130	8,50	2_60
99136	223,00	2_51
99142	289,00	2_46
99145	83,00	2_8
99146	91,00	2_8
99147	99,00	2_8
99154	77,00	2_12
99155	85,00	2_12
99158	55,00	2_14
99159	63,00	2_14
99160	71,00	2_14

Index des références

Item directory

SHOWROOM ET PROFESSIONNEL

Ref.	€	Pág.
99161	57,00	2_14
99162	65,00	2_14
99163	73,00	2_14
99172	40,00	2_64
99173	16,00	1_98
99174	31,00	1_98
99178	90,00	2_15
99185	95,00	2_8
99187	99,00	2_8
99188	103,00	2_8
99190	107,00	2_8
99191	111,00	2_8
99193	115,00	2_8
99208	88,00	2_12
99210	92,00	2_12
99211	96,00	2_12
99213	100,00	2_12
99214	61,00	2_32
99215	85,00	2_32
99216	99,00	2_33
99221	67,00	2_16
99222	69,00	2_16
99223	71,00	2_16
99248	57,00	1_40
99249	65,00	1_40
99250	73,00	1_40
99251	67,00	1_40
99252	75,00	1_40
99253	83,00	1_40
99265	79,00	1_41
99265	79,00	1_104
99308	309,00	1_62
99386	87,00	1_35
99388	91,00	1_35
99389	96,00	1_35
99392	34,00	2_31
99393	27,00	2_31
99440	183,00	1_96
99441	199,00	1_96
99442	263,00	1_96
99443	231,00	1_93
99444	317,00	1_90
99445	355,00	1_90
99445	355,00	1_106
99450	95,00	1_87
99450	95,00	2_51
99451	20,00	1_82
99453	34,00	1_82
99454	37,00	1_82
99455	34,00	1_82
99456	65,00	1_82
99457	93,00	1_82
99458	166,00	1_82
99459	23,00	1_84
99460	34,00	1_84
99461	33,00	1_84
99462	47,00	1_84
99463	43,00	1_84
99464	32,00	1_84
99465	35,00	1_85
99466	55,00	1_85
99467	86,00	1_85
99468	128,00	1_85
99469	109,00	1_87
99470	19,00	1_80
99471	48,00	1_80

Ref.	€	Pág.
99472	64,00	1_80
99473	46,00	1_80
99474	42,00	1_80
99475	54,00	1_80
99476	39,00	1_81
99477	81,00	1_81
99478	101,00	1_81
99479	166,00	1_81
99480	102,00	1_87
99481	23,00	1_88
99482	28,00	1_88
99483	33,00	1_88
99484	38,00	1_88
99600	65,00	1_76
99601	225,00	1_76
99602	139,00	1_76
99603	65,00	1_76
99604	25,00	1_77
99606	39,00	1_77
99607	35,00	1_78
99608	44,00	1_78
99609	16,00	1_67
99610	31,00	1_66
99611	18,00	1_67
99612	24,00	1_67
99613	27,00	1_66
99614	16,00	1_67
99615	17,00	1_66
99616	86,00	2_43
99617	86,00	2_43
99618	41,00	1_73
99619	43,00	1_73
99620	68,00	1_72
99621	42,00	1_72
99622	55,00	1_72
99623	224,00	1_63-1_71
99624	64,00	1_70
99625	69,00	1_70
99626	88,00	1_70
99627	83,00	1_70
99628	89,00	1_70
99646	373,00	1_34
99646	373,00	1_61
99657	31,00	1_98
99658	31,00	1_98
99685	166,00	1_77
99686	157,00	1_77
99687	142,00	1_77
99688	225,00	1_76
99689	225,00	1_76
99690	90,00	1_76
99691	120,00	1_76
99692	90,00	1_76
99693	120,00	1_76
99718	216,00	2_34
99719	135,00	2_36
99720	156,00	2_38
99727	373,00	1_38
99727	373,00	1_61
99731	595,00	1_54
99732	518,00	1_60
99733	254,00	1_9
99733	254,00	1_92
99735	212,00	1_92
99750	60,00	2_20
99751	68,00	2_20

Ref.	€	Pág.
99752	76,00	2_20
99753	60,00	2_20
99754	68,00	2_20
99755	76,00	2_20
99756	98,00	2_21
99757	77,00	2_21
99758	70,00	2_21
99759	49,00	2_21
99760	28,00	2_21
99760	28,00	2_31
99766	53,00	2_20
99767	61,00	2_20
99768	69,00	2_20
99769	86,00	2_21
99770	53,00	2_21
99771	32,00	2_21
99780	60,00	2_18
99781	68,00	2_18
99782	76,00	2_18
99783	68,00	2_18
99784	76,00	2_18
99785	77,00	2_19
99786	49,00	2_19
99787	28,00	2_19
99787	28,00	2_31
99788	53,00	2_18
99789	61,00	2_18
99790	69,00	2_18
99791	86,00	2_19
99792	53,00	2_19
99793	32,00	2_19
99803	63,00	2_61
99804	70,00	2_61
99820	53,00	1_40
99821	61,00	1_40
99822	69,00	1_40
99823	63,00	1_40
99824	71,00	1_40
99825	79,00	1_40
99826	53,00	1_41
99827	61,00	1_41
99828	69,00	1_41
99829	85,00	1_41
99830	75,00	1_41
99831	70,00	1_41
99832	60,00	1_41
99833	75,00	1_41
99833	75,00	1_104
99850	145,00	1_106
99851	145,00	1_106
99862	2,75	2_62
99928	110,00	1_37
99929	118,00	1_37
99930	126,00	1_37
99931	110,00	1_33
99932	118,00	1_33
99933	126,00	1_33
99944	87,00	2_10
99945	91,00	2_10
99946	70,00	2_16
99947	74,00	2_16
99948	93,00	2_15
99949	83,00	2_15
99950	92,00	2_15

Que signifie chaque symbole?

What's the meaning of each icon?

Sécurité Security



MEDICAL
Hygiène maximale
Maximum hygiene



THERMOSTATIQUE
Contrôle thermostatique, haute précision
Thermostatic control, high precision



SAFETY BLOCK
Double système de sécurité pour thermostatique
Double security system for thermostatic



TERMOLIMIT
Limitation de la température
Temperature limit



ANTIVANDÁLICO
Blocage de l'approvisionnement en eau à 55 secondes
Blocking the water supply at 55 seconds

Matériaux Materials



EXTRA BRASS
Laiton de haute qualité
High quality brass



EXTRA CHROME
Chromage de haute qualité
High quality chrome



STAINLESS STEEL
Robinetterie en acier inox
Stainless steel taps



EUROCOLGADOR
Emballage avec orifice pour stockage sur broche
Retail packaging

Environnement Environment



AIR ADVANCED
Mélange air et eau
Air and water mixture



ECONATURE
Cartouche C2/ec2 avec 2 positions
C2/ec2 cartridge with 2 positions



PUBLIC PLACE
Conçu pour les lieux publics
Designed for public places



NOISELESS
Système de réduction du bruit
Noise reduction system



WATER REDUCE
Système de réduction de débit
Flow reduction system

Design et qualité Design & Quality



PATENTED
Design exclusif et breveté
Exclusive and patented design



TOP WARRANTY
Garantie qualité 5 ans
5 years warranty

Technologie Technology



CERAMIC CONTROL
Disques céramiques
Ceramic disc



G180
Tête céramique
Ceramic headworks



GMT
Tête à clapet
Conventional multiturm



COLD OPEN
Ouverture en eau froide
Cold opening



WATERFALL
Effet cascade
Waterfall effect



SUPERFIX
Anti-mouvements évier
Stop movement of sink mixer



ANTI-CAL
Dispositif anticalcaire
Anti lime



ULTRA SLIM
Pomme de douche
Ultra slim fixed heads

Cartouche Cartridge



STANDARD
Modèle standard
Standard model



ECONATURE
Économie d'eau. Cartouche avec 2 positions.
Water saving. Cartridge with 2 positions



ECONATURE + COLDOPEN
Économie d'eau et d'énergie
Water and energy saving

Index

Bahama xtreme	2_08
Start urban	2_12
S12 urban	2_14
G180	2_18
GMT	2_20
Temporisés <i>Delay action taps</i>	2_22
Électroniques <i>Electronic taps</i>	2_24
Douchettes hygiéniques <i>Shattaf</i>	2_28
Lave-mains <i>Cold water taps</i>	2_30
P.M.R. <i>Medical lever operated devices</i>	2_32
Encastrés iclever <i>Concealed basin mixers</i>	2_34
Compléments <i>Accessoires</i>	2_42
Clever Box Colonnes de douche <i>Shower systems</i>	2_44
Accessoires box <i>Box accessories</i>	2_50
Présentoirs <i>Displays</i>	2_52
Vidages et compléments <i>Pop-ups and other accessories</i>	2_60
Pièces de rechange <i>Spare parts</i>	2_62
Information technique <i>Technical information</i>	2_65
Conditions de vente <i>Sale conditions</i>	2_82

Bahama xtreme

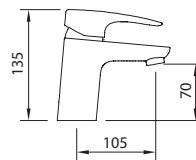
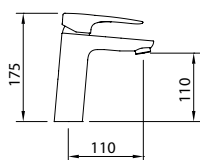

MITIGEUR LAVABO 110 / Basin mixer 110

Mitigeur Lavabo, aérateur, raccords flexibles M-10 3/8" x 500 mm.
Mixer, aerator, flexible hoses M-10 3/8" x 500 mm.

MITIGEUR LAVABO 70 / Basin mixer 70

Mitigeur Lavabo, aérateur, raccords flexibles M-10 3/8" x 420 mm.
Mixer, aerator, flexible hoses M-10 3/8" x 420 mm.

Cartouche / Cartridge



			Ref.	€	☐
			99185	95,00	12
			99188	103,00	12
			99191	111,00	12



98209 98870 99229

Cartouche / Cartridge



			Ref.	€	☐
			99145	83,00	12
			99146	91,00	12
			99147	99,00	12

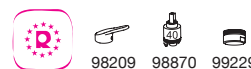

98209 98870 99229

Cartouche / Cartridge



			Ref.	€	☐
			99187	99,00	12
			99190	107,00	12
			99193	115,00	12

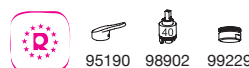

95190 98902 99229

Cartouche / Cartridge



			Ref.	€	☐
			98175	87,00	12
			98181	95,00	12
			98182	103,00	12

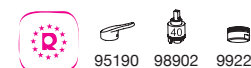

95190 98902 99229

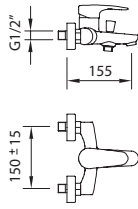

MITIGEUR BAIN-DOUCHE / Bath-shower mixer

Mitigeur bain-douche, aérateur, inverseur automatique.
Bath-shower mixer with aerator, automatic diverter.

Cartouche / Cartridge



REF.
96108
97670
98208

ACS	NF	E _{3/1} C ₁ A ₁ U ₃	Ref.	€	□
			99121	155,00	8

Sans kit de douche
Without shower kit

ACS	NF	E _{3/1} C ₁ A ₁ U ₃	Ref.	€	□
			98282	135,00	8

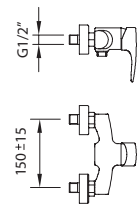

MITIGEUR DOUCHE / Shower mixer

Mitigeur douche.
Shower mixer.

Cartouche / Cartridge



REF.
96108
97670
98208

ACS	NF	E ₁ C ₁ A ₂ U ₃	Ref.	€	□
			99122	124,00	8

Sans kit de douche
Without shower kit

ACS	NF	E ₁ C ₁ A ₂ U ₃	Ref.	€	□
			98283	104,00	8

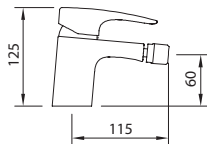

MITIGEUR BIDET / Bidet mixer

Mitigeur bidet, aérateur rotule, raccords flexibles M-10 3/8" x 370 mm.
Mixer, swivel aerator, flexible hoses M-10 3/8" x 370 mm.

Cartouche / Cartridge



ACS	NF	E ₀ C ₂ A ₁ U ₃	Ref.	€	□
			98176	85,00	12
			98183	93,00	12
			98184	101,00	12

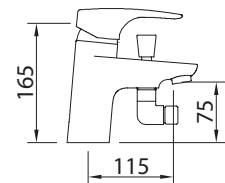

Le coude peut se retirer
The elbow can be removed

MITIGEUR BAIN-DOUCHE MONOTROU / Bath-shower mixer

Mitigeur bain-douche - Monotrou, aérateur, raccords flexibles M-10 3/8" x 370 mm.
Mixer, diverter aerator, flexible hoses M-10 3/8" x 370 mm.

Cartouche / Cartridge



REF.
96108
97670
98208

ACS	NF	E _{3/1} C ₁ A ₁ U ₃	Ref.	€	□
			98753	121,00	8



Produits connexes
Related products



PAG. xxx

SYNTHÉTIQUE_ 99130
Vidage Universel
Universal drain quick-clac



PAG. xxx

MÉTALLIQUE_ 99127
Vidage Universel
Universal drain quick-clac



PAG. xxx

LEO_ 60558
Vidage Universel
Universal drain quick-clac



PAG. xxx

elegance_ 99803
Colonettes
Bath Legs



PAG. xxx

Xtreme_ 99803
Colonettes
Bath Legs

Bahama xtreme



MITIGEUR ÉVIER Horizontal sink mixer

Mitigeur évier bec orientable, aérateur, raccords flexibles M-10 3/8" x 370 mm.
Mixer, aerator, swivel spout flexible hoses M-10 3/8" x 370 mm.

Cartouche / Cartridge

C1	ACS	NF	E ₀ C ₃ A ₁ U ₃	Ref.	€	8
				99944	87,00	8
	98209	98870	60155	97688		

Cartouche / Cartridge

C3	ACS	NF	E ₀ C ₃ A ₁ U ₃	Ref.	€	8
				99945	91,00	8
	98209	98902	60155	97688		

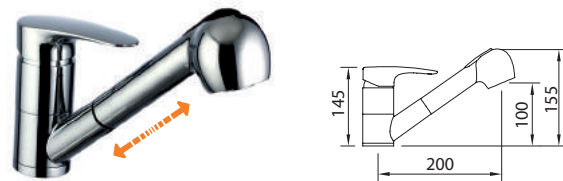

MITIGEUR ÉVIER AVEC DOUCHETTE EXTRACTIBLE Pull-out sink mixer

Mitigeur évier bec orientable, douchette extractible, aérateur, raccords flexibles M-10 3/8" x 370 mm.
Mixer with aerator, swivel spout, pull-out handshower and flexible hoses M-10 3/8" x 370 mm.

Cartouche / Cartridge

ec2	ACS	NF	E ₀ C ₃ A ₁ U ₃	Ref.	€	8
				98180	164,00	8
	98209	97370	97688			
	2 Fonctions 90794	96117				

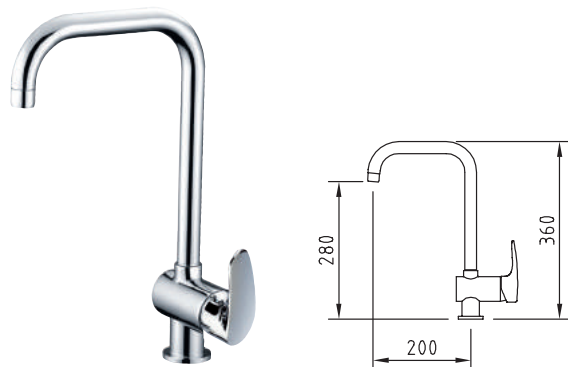

MITIGEUR ÉVIER / Sink mixer

Mitigeur évier bec orientable, aérateur, raccords flexibles M-10 3/8" x 420 mm.
Mixer, aerator, swivel tube spout, flexible hoses M-10 3/8" x 420 mm.

Cartouche / Cartridge

ec2	ACS	NF	E ₀ C ₃ A ₁ U ₃	Ref.	€	8
				98913	153,00	8
	98210	98781	97688	99232		

Cartouche / Cartridge

C3	ACS	NF	E ₀ C ₃ A ₁ U ₃	Ref.	€	8
				98179	158,00	8
	95191	98903	97688	99232		

Technologie / Technology

COLD OPEN. SYSTÈME D'OUVERTURE EN EAU FROIDE POUR FAIRE DES ÉCONOMIES D'ÉNERGIE.

Cold Open system. It opens in cold position. You save energy.



SYSTÈME ECONATURE ÉCONOMIE D'EAU.

Deux positions d'ouverture de la poignée.

Econature system. Save water. Two positions of opening the handle.

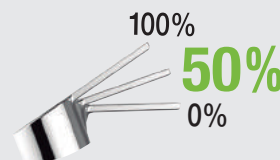



98175
Mitigeur Lavabo
Basin Mixer

Start urban

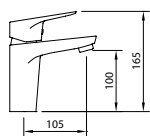

MITIGEUR LAVABO 100 / Tall basin mixer 100

Mitigeur lavabo, aérateur, raccords flexibles M-10 3/8" x 420 mm.
Mixer, aerator, flexible hoses M-10 3/8" x 420 mm.

Cartouche / Cartridge



	Ref.	€	Q
	99208	88,00	12
	99211	96,00	12



95181 98870 99229

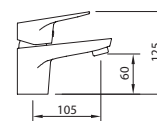

MITIGEUR LAVABO 60 / Basin mixer 60

Mitigeur lavabo, aérateur, raccords flexibles M-10 3/8" x 420 mm.
Mixer, aerator, flexible hoses M-10 3/8" x 420 mm.

Cartouche / Cartridge



	Ref.	€	Q
	E ₀ C ₃ A ₁ U ₃	99154	77,00 12
	E ₀ C ₃ A ₁ U ₃	99155	85,00 12

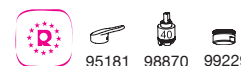

95181 98870 99229

Cartouche / Cartridge



	Ref.	€	Q
	99210	92,00	12
	99213	100,00	12

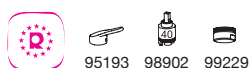

95193 98902 99229

Cartouche / Cartridge



	Ref.	€	Q
	E ₀ C ₃ A ₁ U ₃	98616	81,00 12
	E ₀ C ₃ A ₁ U ₃	98617	89,00 12



95193 98902 99229

Produits connexes Related products

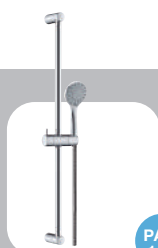

PAG. 1.70

CITY AIR _ 99624
Kit douche
Shower kit



PAG. 2.60

LEO _ 98674
Vidage Universel
Universal drain quick-clac



PAG. 2.61

DESIGN _ 40010
Robinet d'angle
Angle Valve



PAG. 1.53

NINE urban _ 60325
Mitigeur douche thermostatique
Thermostatic shower mixer

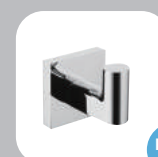

PAG. 1.84

urban _ 99459
Accessoires de salle de bain
Bathroom accessories

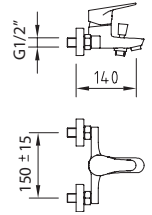

MITIGEUR BAIN-DOUCHE
Bath-shower mixer

Mitigeur bain-douche, aérateur, inverseur intégré
Bath-shower mixer with aerator, hidden diverter.

Cartouche / Cartridge



Sans kit de douche
Without shower kit

Ref.	€	Q
ACS NF E _{3/1} C ₁ A ₁ U ₃ 98645	105,00	8

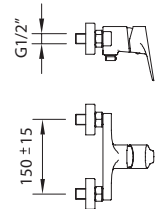

MITIGEUR DOUCHE
Shower mixer

Mitigeur douche
Shower mixer.

Cartouche / Cartridge



Sans kit de douche
Without shower kit

Ref.	€	Q
ACS NF E ₁ C ₁ A ₂ U ₃ 98646	83,00	8

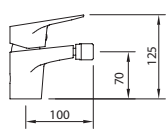
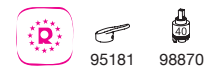

MITIGEUR BIDET / Bidet mixer

Mitigeur bidet, aérateur rotule, raccords flexibles M-10 3/8" x 420 mm.
Mixer, swivel aerator, flexible hoses M-10 3/8" x 420 mm.

Cartouche / Cartridge



Ref.	€	Q
ACS 98618	77,00	12
ACS 98619	85,00	12

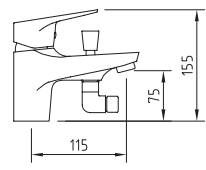

MITIGEUR BAIN-DOUCHE MONOTROU / Bath-shower mixer

Mitigeur bain-douche - Monotrou, aérateur, raccords flexibles M-10 3/8" x 370 mm.
Mixer, diverter aerator, flexible hoses M-10 3/8" x 370 mm.

Cartouche / Cartridge



Sans kit de douche
Without shower kit

Ref.	€	Q
ACS NF E _{3/1} C ₁ A ₁ U ₃ 98755	93,00	8

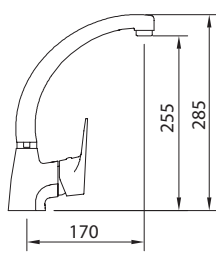

MITIGEUR ÉVIER, BEC TUBE / Sink mixer

Mitigeur évier bec orientable, aérateur, raccords flexibles M-10 3/8" x 420 mm.
Mixer with aerator, swivel tube spout, flexible hoses M-10 3/8" x 420 mm.

Cartouche / Cartridge



Ref.	€	Q
ACS NF E ₀ C ₃ A ₁ U ₃ 98615	92,00	12



S12 urban

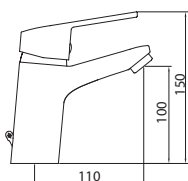



MITIGEUR LAVABO 100 / Basin mixer 100

Mitigeur lavabo, aérateur, raccords flexibles M-10 3/8" x 420 mm.
Basin mixer with aerator, flexible hoses M-10 3/8" x 420 mm.

Cartouche / Cartridge



	Ref.	€	Q
	60716	63,00	12
	60717	71,00	12
	60718	79,00	12

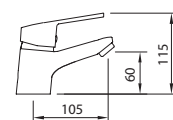







MITIGEUR LAVABO 60 / Basin mixer 60

Mitigeur lavabo, aérateur, raccords flexibles M-10 3/8" x 370 mm.
Basin mixer with aerator, flexible hoses M-10 3/8" x 370 mm.

Cartouche / Cartridge





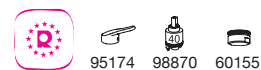



	Ref.	€	Q
 	E ₀ C ₁ A ₁ U ₃ 99158	55,00	12
 	E ₀ C ₁ A ₁ U ₃ 99159	63,00	12
 	E ₀ C ₁ A ₁ U ₃ 99160	71,00	12



Cartouche / Cartridge









	Ref.	€	Q
 	E ₀ C ₂ A ₁ U ₃ 99161	57,00	12
 	E ₀ C ₂ A ₁ U ₃ 99162	65,00	12
 	E ₀ C ₂ A ₁ U ₃ 99163	73,00	12



Cartouche / Cartridge



	Ref.	€	Q
 	E ₀ C ₃ A ₁ U ₃ 98800	59,00	12
 	E ₀ C ₃ A ₁ U ₃ 98805	67,00	12
 	E ₀ C ₃ A ₁ U ₃ 98806	75,00	12





MITIGEUR BAIN-DOUCHE / Bath-shower mixer

Mitigeur bain-douche, aérateur, inverseur
Bath-shower mixer, aerator, automatic diverter.

Cartouche / Cartridge



REF.
98342
97670
98343

Sans kit de douche
Without shower kit

	Ref.	€	
E _{3/1} C ₁ A ₁ U ₃	98807	101,00	8
E _{3/1} C ₁ A ₁ U ₃	98801	91,00	8



Cartouche / Cartridge



Sans kit de douche
Without shower kit

	Ref.	€	
E _{3/1} C ₂ A ₁ U ₃	99948	93,00	8

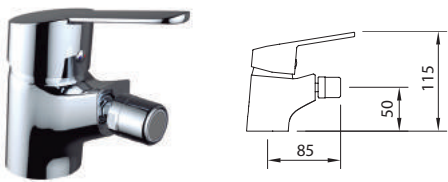

MITIGEUR BIDET / Bidet mixer

Mitigeur bidet, aérateur rotule, raccords flexibles M-10 3/8" x 370 mm.
Mixer, swivel aerator, flexible hoses M-10 3/8" x 370 mm.

Cartouche / Cartridge



	Ref.	€	
	98331	53,00	12
	98338	61,00	12
	98339	69,00	12



MITIGEUR DOUCHE / Shower mixer

Mitigeur douche. / Shower mixer.

Cartouche / Cartridge



REF.
98342
97670
98343

Sans kit de douche
Without shower kit

	Ref.	€	
E ₁ C ₁ A ₂ U ₃	98808	91,00	8
E ₁ C ₁ A ₂ U ₃	98802	81,00	8



Cartouche / Cartridge



Sans kit de douche
Without shower kit

	Ref.	€	
E ₁ C ₂ A ₂ U ₃	99949	83,00	8

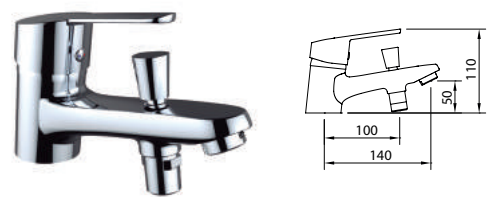

MITIGEUR BAIN-DOUCHE MONOTROU / Bath-shower mixer

Mitigeur bain-douche - Monotrou, aérateur, raccords flexibles M-10 3/8" x 370 mm.
Mixer, diverter aerator, flexible hoses M-10 3/8" x 370 mm.

Cartouche / Cartridge



Sans kit de douche
Without shower kit

	Ref.	€	
E _{3/1} C ₁ A ₁ U ₃	99178	90,00	-

95174 98870 96200 98490 99138 Anti-retour Check valve

Cartouche / Cartridge



Sans kit de douche
Without shower kit

	Ref.	€	
E _{3/1} C ₂ A ₁ U ₃	99950	92,00	-

95174 98871 96200 98490 99138 Anti-retour Check valve

Produits connexes
Related products



SYNTHÉTIQUE_ 99130
Vidage Universel
Universal drain quick-clac



MÉTALLIQUE_ 99127
Vidage Universel
Universal drain quick-clac



LEO_ 60558
Vidage Universel
Universal drain quick-clac



elegance_ 99803
Colonettes
Bath Legs



Xtreme_ 99803
Colonettes
Bath Legs

S12 urban

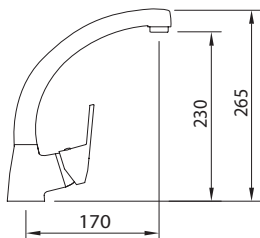





MITIGEUR ÉVIER BEC TUBE Sink mixer

Mitigeur évier bec orientable, aérateur, raccords flexibles M-10 3/8" x 370 mm.
Mixer with aerator, swivel tube spout, flexible hoses M-10 3/8" x 370 mm.

Cartouche / Cartridge

ec1	Ref.	€	12
 	98334	75,00	12
			
95175	98237	99229	

Cartouche / Cartridge

C3	Ref.	€	12
 	E ₀ C ₃ A ₁ U ₃ 98803	79,00	12
			
95196	98903	60155	

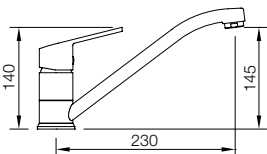

MITIGEUR ÉVIER Horizontal sink mixer

Mitigeur évier bec orientable, aérateur, raccords flexibles M-10 3/8" x 370 mm.
Sink mixer, aerator, swivel spout, flexible hoses M-10 3/8" x 370 mm.

Cartouche / Cartridge

C1	Ref.	€	12
 	E ₃ C ₁ A ₁ U ₃ 99946	70,00	12
			
95195	98802	60155	

Cartouche / Cartridge

C3	Ref.	€	12
 	E ₃ C ₃ A ₁ U ₃ 99947	74,00	12
			
95195	98802	60155	

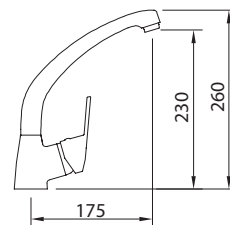





MITIGEUR ÉVIER BEC FONTE Sink mixer

Mitigeur évier bec orientable, aérateur, raccords flexibles M-10 3/8" x 370 mm.
Mixer with aerator, swivel cast spout and connections M10-3/8" x 370 mm.

Cartouche / Cartridge

ec1	Ref.	€	12
 	98344	81,00	12
			
95175	98237	99229	

Cartouche / Cartridge

C3	Ref.	€	12
 	E ₀ C ₃ A ₁ U ₃ 98804	85,00	12
			
95196	98903	60155	

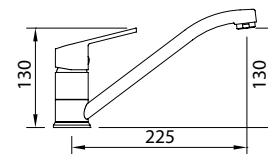

MITIGEUR ÉVIER Horizontal sink mixer

Mitigeur évier bec orientable, aérateur, raccords flexibles M-10 3/8" x 370 mm.
Sink mixer, aerator, swivel spout, flexible hoses M-10 3/8" x 370 mm.

Cartouche / Cartridge

ec1	Ref.	€	12
	99221	67,00	12
			
99224	99226	90025	

Cartouche / Cartridge

ec2	Ref.	€	12
	99222	69,00	12
			
99224	99227	90025	

Cartouche / Cartridge

ec3	Ref.	€	12
	99223	71,00	12
			
99225	99228	90025	



G180



Aérateur "coinslot"
Coinslot aerator

180° **NF** **TÊTE CÉRAMIQUE**
Ceramic headworks

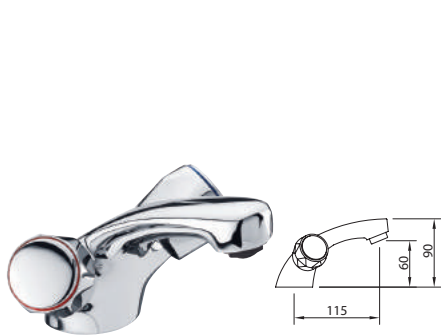

MÉLANGEUR LAVABO 60

Basin mixer 60

Mélangeur lavabo, aérateur, raccords flexibles M-10 3/8" x 370 mm.
Mixer, aerator, flexible hoses M-10 3/8" x 370 mm.



MÉLANGEUR LAVABO HAUT 180

Tall basin mixer 180

Mélangeur lavabo, aérateur, raccords flexibles M-10 3/8" x 370 mm.
Mixer with aerator, swivel tube spout, flexible hoses M-10 3/8" x 370 mm.



MÉLANGEUR BIDET

Bidet mixer

Mélangeur bidet, aérateur rotule, raccords flexibles M-10 3/8" x 370 mm.
Mixer, swivel aerator, flexible hoses M-10 3/8" x 370 mm.

	Ref.	€	📦
	99780	60,00	12
	99781	68,00	12
	99782	76,00	12



	Ref.	€	📦
	99788	53,00	12
	98789	61,00	12
	98790	69,00	12



	Ref.	€	📦
	99783	68,00	-
	99784	76,00	-



Produits connexes

Related products



urban _ 98650
Accessoires de salle de bain
Bathroom accessories



LEO _ 99398
Vidage Universel
Universal drain quick-clac



SIFÓN BOTELLA LATÓN _ 90755
Siphon laiton
Brass bottle trap



DESIGN _ 40010
Robinet d'equerre
Angle Valve



MÉLANGEUR BAIN-DOUCHE
Bath-shower mixer

Mélangeur bain-douche, aérateur, inverseur automatique.
Bath-shower mixer, aerator, automatic diverter.

	Ref.	€	
Sans kit de douche Without shower kit	99785	77,00	-



MÉLANGEUR DOUCHE
Shower mixer

Mélangeur douche.
Shower mixer.

	Ref.	€	
Sans kit de douche Without shower kit	99786	49,00	-



MÉLANGEUR BAIN-DOUCHE MONOTROU
Bath-shower mixer

Mitigeur bain-douche - Monotrou, aérateur, raccords flexibles M-10 3/8" x 370 mm.
Mixer, diverter aerator, flexible hoses M-10 3/8" x 370 mm.

	Ref.	€	
Sans kit de douche Without shower kit	99791	86,00	-

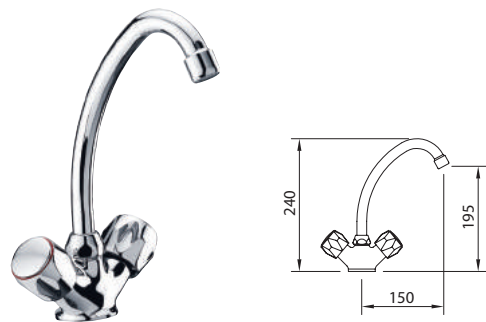

MÉLANGEUR ÉVIER
Sink mixer

Mélangeur évier, bec orientable, aérateur, raccords flexibles M-10 3/8" x 370 mm.
Mixer with aerator, swivel tube spout, flexible hoses M-10 3/8" x 370 mm.

	Ref.	€	
Sans kit de douche Without shower kit	99792	53,00	-

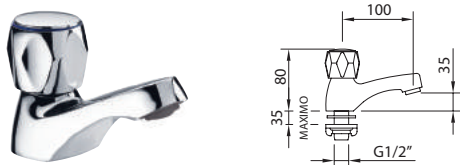

ROBINET SIMPLE
Single tap

Robinet lavabo, aérateur.
Deck mounted single basin faucet, with aerator, cold water indice.

	Ref.	€	
Sans kit de douche Without shower kit	99787	28,00	24

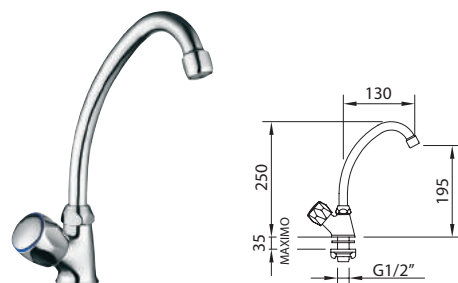

ROBINET ÉVIER SIMPLE
Sink mixer

Robinet évier bec orientable, aérateur.
Deck mounted single faucet aerator and swivel tube spout.

	Ref.	€	
Sans kit de douche Without shower kit	99793	32,00	-





Aérateur "coinslot"
Coinslot aerator



TÊTE À CLAPET
Conventional multiturn

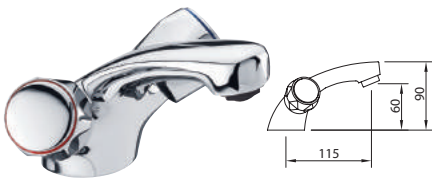

MÉLANGEUR LAVABO 60
Basin mixer 60

Mélangeur lavabo, aérateur, raccords flexibles M-10 3/8" x 370 mm.
Mixer, aerator, flexible hoses M-10 3/8" x 370 mm.



MÉLANGEUR LAVABO HAUT 180
Tall basin mixer 180

Mélangeur lavabo, aérateur, raccords flexibles M-10 3/8" x 370 mm.
Mixer with aerator, swivel tube spout, flexible hoses M-10 3/8" x 370 mm.



MÉLANGEUR BIDET
Bidet mixer

Mélangeur bidet, aérateur rotule, raccords flexibles M-10 3/8" x 370 mm.
Mixer, swivel aerator, flexible hoses M-10 3/8" x 370 mm.

	Ref.	€	📦
	99750	60,00	12
	99751	68,00	12
	99752	76,00	12



60366 60365 60155

	Ref.	€	📦
	99766	53,00	12
	99767	61,00	12
	99768	69,00	12



60366 60365 99232

	Ref.	€	📦
	99753	60,00	-
	99754	68,00	-
	99755	76,00	-



60366 60365 99232

Produits connexes
Related products



PAG. 1.86

Urban _ 98650
Accessoires de salle de bain
Bathroom accessories



PAG. 2.60

LEO _ 99398
Vidage Universel
Universal drain quick-clac



PAG. 2.61

SIFÓN BOTELLA LATÓN _ 90755
Siphon laiton
Brass bottle trap

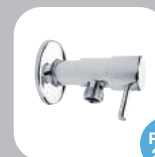

PAG. 2.61

DESIGN _ 40010
Robinet d'équerre
Angle Valve



MÉLANGEUR BAIN-DOUCHE
Bath-shower mixer

Mélangeur bain-douche, aérateur, inverseur automatique.
Bath-shower mixer, aerator, automatic diverter.

	Ref.	€	📦
REF. 98342, 97670, 98343	99756	98,00	8
Sans kit de douche Without shower kit	99757	77,00	8

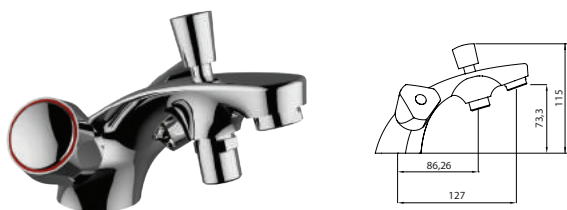

MÉLANGEUR BAIN-DOUCHE MONOTROU
Bath-shower mixer

Mitigeur bain-douche - Monotrou, aérateur, raccords flexibles M-10 3/8" x 370 mm.
Mixer, diverter aerator, flexible hoses M-10 3/8" x 370 mm.

	Ref.	€	📦
Sans kit de douche Without shower kit	99769	86,00	-

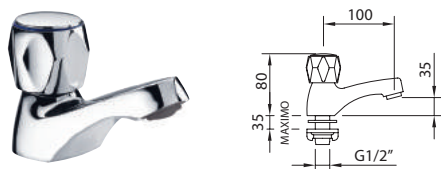

ROBINET SIMPLE
Single tap

Robinet lavabo, aérateur.
Deck mounted single basin faucet, with aerator, cold water indice.

	Ref.	€	📦
	99760	28,00	24



MÉLANGEUR DOUCHE
Shower mixer

Mélangeur douche.
Shower mixer.

	Ref.	€	📦
REF. 98342, 97670, 98343	99758	70,00	12
Sans kit de douche Without shower kit	99759	49,00	8

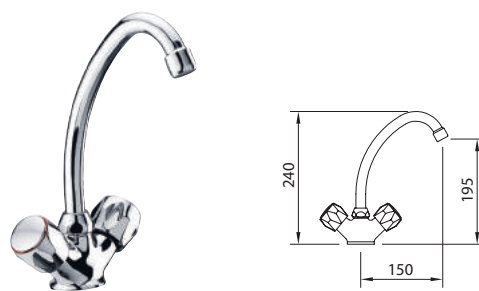
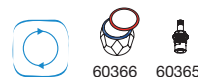

MÉLANGEUR ÉVIER
Sink mixer

Mélangeur évier, bec orientabl, eaérateur, raccords flexibles M-10 3/8" x 370 mm.
Mixer with aerator, swivel tube spout, flexible hoses M-10 3/8" x 370 mm.

	Ref.	€	📦
	99770	53,00	12

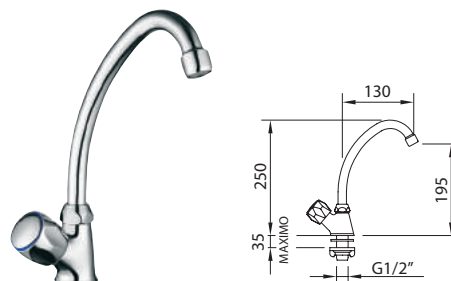

ROBINET ÉVIER SIMPLE
Sink mixer

Robinet évier bec orientable, aérateur.
Deck mounted single faucet aerator and swivel tube spout.

	Ref.	€	📦
	99771	32,00	8



Temporisés *Delay action*

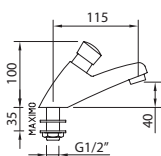

ROBINET TEMPORISÉ *Delay action basin tap*

Robinet simple, avec aérateur, 14 secondes, cartouche M26.
Deck mounted basin tap, with aerator, 14 seconds, cartridge M26.

Ref.	€	📦
96127	55,00	24

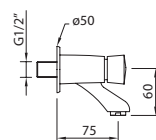

ROBINET TEMPORISÉ MURAL *Wall mounted delay action basin tap*

Robinet simple, avec aérateur, 14 secondes, cartouche M26.
Wall mounted basin tap, with aerator, 14 seconds, cartridge M26.

Ref.	€	📦
96128	42,00	24

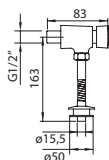

ROBINET TEMPORISÉ URINOIR MURAL *Wall mounted urinal flush valve*

Robinet temporisé urinoir 1/2", 7 secondes, cartouche M26.
Urinal 1/2", 7 seconds, cartridge M26.

Ref.	€	📦
92801	45,00	24

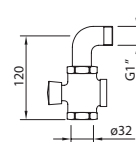

ROBINET TEMPORISÉ SANITAIRE MURAL *Wall mounted sanitary flush valve*

Robinet temporisé urinoir mural.
Urinal external fluxor.

Ref.	€	📦
96152	66,00	24



Nouveau robinet temporisé avec système autonettoyant de plus grande durabilité

New delay action with self-cleaning system and greater durability



Cartouche autonettoyante.

Self-cleaning cartridge.



Aérateur extra plat et antivandalisme.

Aerated and anti-vandalism aerator.



Filtre antiparticules intégré à l'entrée d'eau

Particle filter integrated in the water inlet.

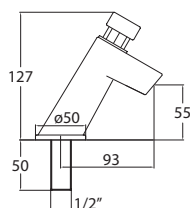

ROBINET TEMPORISÉ
Delay action basin tap

Robinet simple, avec aérateur, 14 secondes cartouche M28.
Deck mounted basin tap, with aerator, 14 seconds, cartridge M28.

Ref.	€	
60734	58,00	-



cosedal



60737



60149

NEOPERL

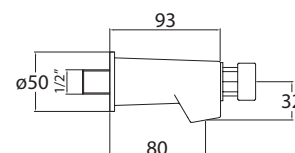

ROBINET TEMPORISÉ MURAL
Wall mounted delay action basin tap

Robinet simple, avec aérateur, 14 secondes cartouche M28.
Wall mounted basin tap, with aerator, 14 seconds, cartridge M28.

Ref.	€	
60735	45,00	-



cosedal



60737



60149

NEOPERL

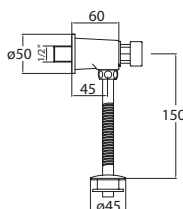

ROBINET TEMPORISÉ URINOIR MURAL
Wall mounted urinal flush valve

Robinet temporisé urinoir 1/2", 7 secondes, cartouche M28.
Urinal 1/2", 7 seconds, cartridge M28.

Ref.	€	
60736	48,00	-



cosedal



60738

Cartouche

Durabilité mécanique
Mechanic Duration

210.000

Cycles de vie / Lifecycles

La cartouche doit résister à une pression maximale de 25 bars pendant 60 secondes.

Pression recommandée: **3 bars.**

*25 bars is the maximum pressure that must be resisted for 60s.
Recommended pressure: 3 bars.*

Selon la norme: EN-816
According to standard: EN-816

*Ces données ne sont que des valeurs de référence.
These data are only reference values.

60734 / 60735 / 60736

Disponible à partir de Septembre 2019
Available from September 2019

Électroniques *Electronic devices*

Nouveaux robinets électroniques

New electronic faucets



POWERED BY

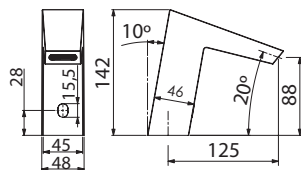

PLATINUM

LAVABO ÉLECTRONIQUE 90 - ROBINET 1 EAU SENSOR TAP 90 - 1 water

Robinet simple avec aérateur. Boîtier (60741) et flexible inclus.
Deck mounted basin tap with aerator. Box (60741) and flexible included.

Ref.	€	
60739	330,00	-

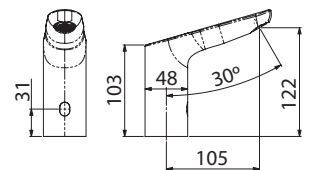

elegance

LAVABO ÉLECTRONIQUE 120 - ROBINET 1 EAU SENSOR TAP 120 - 1 water

Robinet simple avec aérateur. Boîtier (60741) et flexible inclus.
Deck mounted basin tap with aerator. Box (60741) and flexible included.

Ref.	€	
60740	290,00	-



12 cm
Distance de détection
Detection distance



Capteur anti-vandalisme.
Blocage de l'approvisionnement en eau
au bout de 55 secondes.

Anti-vandalism sensor. Blocking the water supply at 55 seconds.

Aérateur anti-vandalisme.
Un outil spécial est nécessaire
pour le démontage.

Anti-vandal aerator. Special tool is required for dismantling.

0,5 à 8 bar
7,3 à 116 psi
Pression de travail
Working pressure

-20 à 70°C
Temp. de stockage
Storage temperature

15 à 50°C
Temp. de fonctionnement
Operating temperature

Amélioration significative de l'hygiène et du confort

Important improvement of hygiene and comfort

PROFESSIONNEL

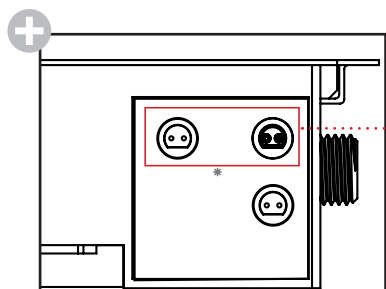

Connexion du capteur
Sensor tap connection

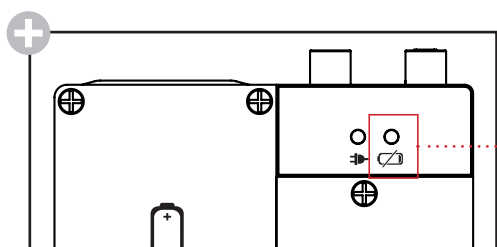

Indicateurs LED
Led indicators

Lorsque la batterie est faible, une led intermittente de COULEUR ROUGE s'allume.

When the battery is running low, an intermittent RED COLOR led lights up.

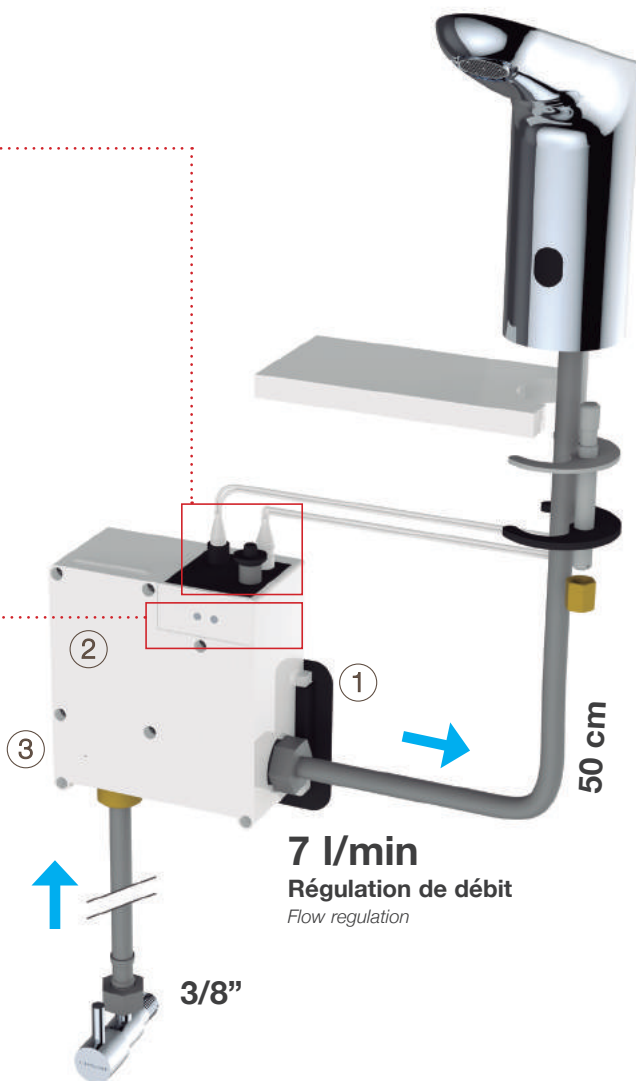

Installation et entretien

Installation and maintenance

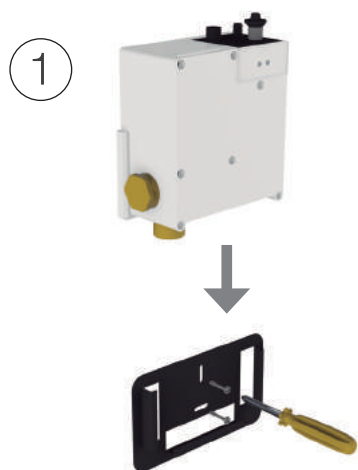

Fixation du boîtier
Wall box fixing

✓ **Support mural inclus**
Enclosure wall box included

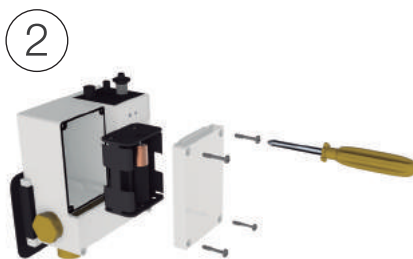

Changement des piles
Change the batteries

✓ **6xAA (non inclus)**
6xAA (not included)

✓ **Il est recommandé d'utiliser des piles alcalines.**
It is recommended to use alkaline batteries.

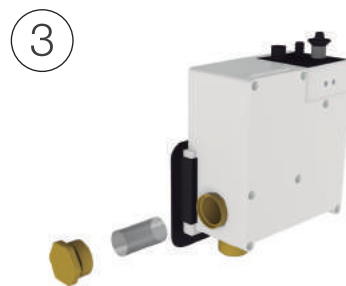

Nettoyage du filtre
Filter cleaning

✓ **Il est nécessaire de fermer le robinet d'arrêt pour nettoyer le filtre.**
It is necessary to cut off the stopcock to clean the filter.

Électroniques *Electronic devices*

Pièces de rechange *Spare parts*

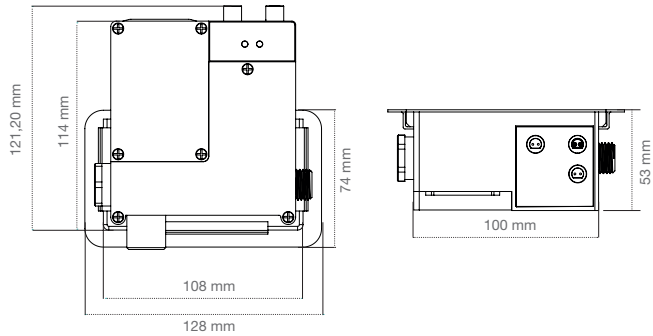

BOÎTIER STANDARD STANDARD BOX

Boîtier standard avec support fixation murale incluse.
Standard box with enclosure wall included.

Ref.	€	📦
60741	105,00	-



BOÎTIER STANDARD

Standard box

Le boîtier standard est un boîtier compact intégrant plusieurs composants automatisés. Une installation facile et rapide, pour un résultat très esthétique.

The standard box is an easy solution to install with the integration of several automation components in a compact box. The installation is practical, fast and esthetic.



Caractéristiques <i>Features</i>	6 V
Piles <i>Battery</i>	6xAA
Dimensions <i>Dimensions</i>	110 x 100 x 53 mm

Protection <i>Protection</i>	IP67
Matériel du boîtier <i>Box material</i>	ABS blanc <i>White</i>

Option d'utilisation avec connexion au courant électrique

Option of use with power supply



PROFESSIONNEL

Pièces de rechange Spare parts

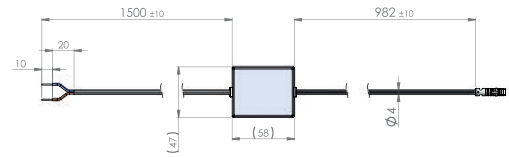

Conformité aux normes
Standard compliance

CÂBLE D'ALIMENTATION POWER SUPPLY

250 cm

Ref.	€	📦
60742	69,00	-

Connexion au courant électrique Current connection

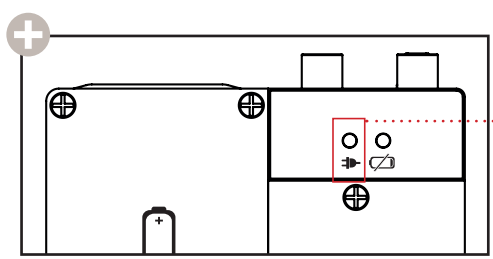
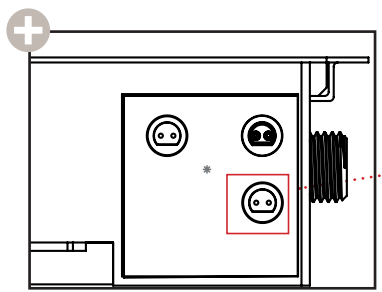
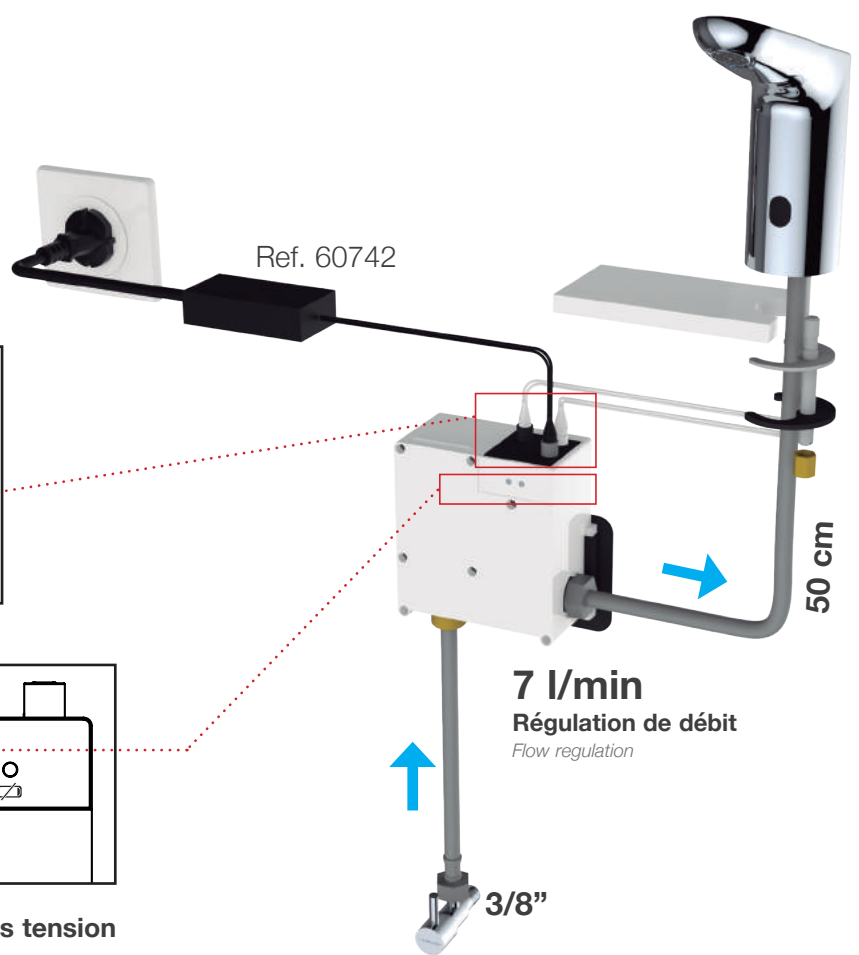

Indicateur LED de mise sous tension Power supply led

Si le boîtier est connecté au courant électrique, le voyant LED de couleur verte reste allumé en permanence. Il est recommandé de laisser les piles installées même si votre appareil est branché sur le courant électrique, afin qu'en cas de coupure de courant, votre robinetterie continue à fonctionner.

If it is connected to the power, the GREEN LED is always on. Even if we use the current option, you need to have the batteries in its place. In case of power failure, it continues working with the batteries.

Pression de travail Working pressure	0,5 à 8 bar 7,3 à 116 psi
Temp. de stockage Storage temperature	-20 à 70°C
Temp. de fonctionnement Operating temperature	15 à 50°C

Douchettes hygiéniques *Shattaf*

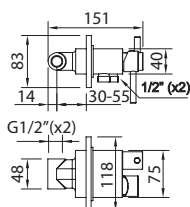
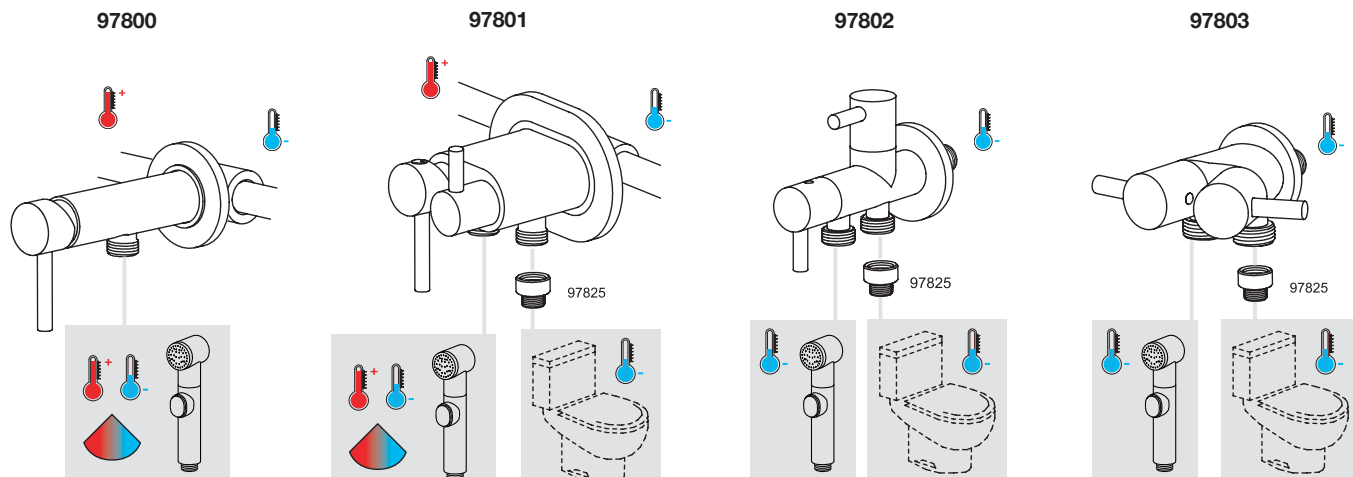

SHATTAF TOUAREG

Mitigeur mural pour douchette hygiénique et sortie réservoir de chasse d'eau.
Wall mounted single mixer shattaf with water tank outlet.

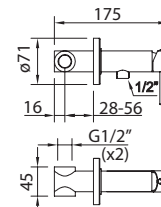

SHATTAF ATLAS

Mitigeur mural pour douchette hygiénique.
Wall mounted single mixer shattaf.



Ref.	€	Q
97801	114,00	6

Inclus
Includes



96136 1,20m
Inox

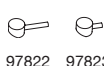

97822 97823 97824



1/2" F-3/8" M 98988
97825

Ref.	€	Q
97800	86,00	6

Inclus
Includes



96136 1,20m
Inox

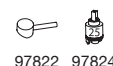

97822 97824



98988

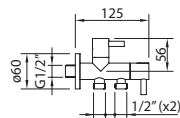

SHATTAF CAMEL

Robinet pour douchette hygiénique et sortie réservoir de chasse d'eau.
Shattaf bidet spray with water tank outlet.

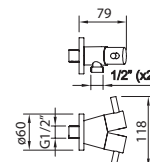

SHATTAF OASIS

Robinet pour douchette hygiénique et sortie réservoir de chasse d'eau.
Shattaf bidet spray with water tank outlet.



Ref.	€	Q
97802	64,00	6

Inclus
Includes



96136 1,20m
Inox

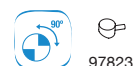

97823



1/2" F-3/8" M 98988
97825

Ref.	€	Q
97803	59,00	6

Inclus
Includes



96136 1,20m
Inox



97823

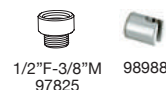

1/2" F-3/8" M 98988
97825

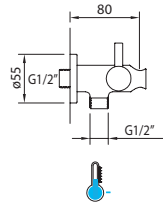

SHATTAF SAHARA

Robinet pour douchette hygiénique avec support intégré.
Shattaf with support included.

Ref.	€	📦
98442	52,00	10

Inclus Includes

96136	1,20m Inox

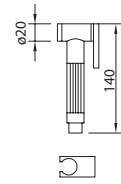

SHATTAF KIRA

Douchette hygiénique laiton.
Brass hygienic handshower.

Ref.	€	📦
98799	36,00	50

Inclus Includes

98988	1,20m Inox 97816

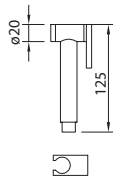

SHATTAF NINA

Douchette hygiénique laiton.
Brass hygienic handshower.

Ref.	€	📦
98798	34,00	50

Inclus Includes

98988	1,20m Inox 97816

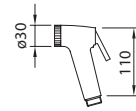

**DOUCHETTE HYGIÉNIQUE
Hygienic handshower**

Douchette hygiénique, ABS.
Hygienic handshower, ABS.

Ref.	€	📦
96136	25,00	20

Inclus Includes

1,20m Inox 97816

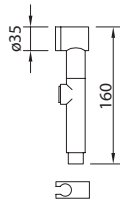

**SAHEL DOUCHETTE HYGIÉNIQUE
Hygienic handshower**

Douchette hygiénique, ABS.
Hygienic handshower, ABS.

Ref.	€	📦
97809	17,00	20

Inclus Includes

98988	1,20m Inox 97816

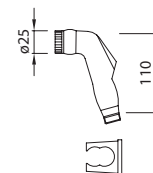

**DOUCHETTE HYGIÉNIQUE
Hygienic handshower**

Douchette hygiénique, ABS.
Hygienic handshower, ABS.

Ref.	€	📦
97740	28,00	50

Inclus Includes

98988	1,50m plastificado

Lave-mains *Cold water taps*

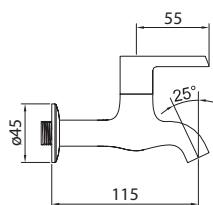

DESIGN

ROBINET SIMPLE MURAL *Wall mounted single tap*

Robinet.
Wall mounted single tap.

Ref.	€	☐
60696	23,00	-



60699 60700

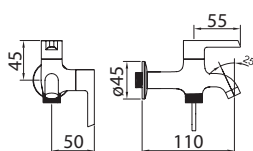

DESIGN

LAVE-MAIN / LAVE LINGE *Wall mounted sink and washing-machine tap*

Robinet, aérateur.
Wall mounted single tap.

Ref.	€	☐
60697	35,00	-



60699 60700

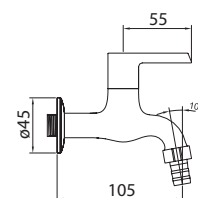

DESIGN

LAVE-MAIN / ROBINET JARDIN *Sink and washing-machine tap*

Robinet mural. Sortie 1/2" + raccord pour tuyau.
Wall mounted single tap. 1/2" outlet + hose fitting.

Ref.	€	☐
60698	26,00	-



60699 60700

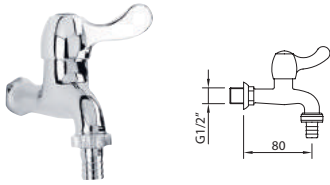

LAVE-MAIN / ROBINET JARDIN
Sink and washing-machine tap
 Robinet, aérateur. Raccord pour tuyau.
 Wall mounted single tap. Hose fitting.

Ref.	€	📦
96133	17,00	96

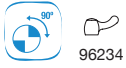

START elegance
LAVE-MAIN
Single washbain wall tap
 Robinet, aérateur.
 Wall single basin tap, with aerator.

Ref.	€	📦
ACS 99393	27,00	12



WITH2 guayama
ROBINET SIMPLE MURAL
Wall mounted single tap
 Robinet, aérateur.
 Wall mounted single basin faucet, with aerator, cold water index.

Ref.	€	📦
ACS 98451	28,00	72

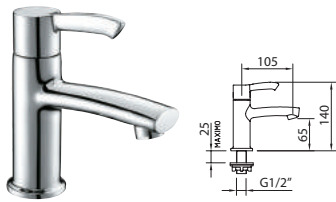

DESIGN
LAVE-MAIN / Single washbain tap
 Robinet, aérateur.
 Deck mounted single basin tap, with aerator.

Ref.	€	📦
98448	60,00	10

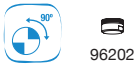

LAVE-MAIN / Single washbain tap
 Robinet, aérateur.
 Deck mounted single basin tap, with aerator.

Ref.	€	📦
96134	32,00	24

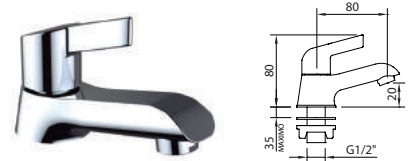

START elegance
LAVE-MAIN / Single washbain tap
 Robinet, aérateur.
 Deck mounted single basin tap, with aerator.

Ref.	€	📦
ACS 99392	34,00	12



S12 urban
LAVE-MAIN / Single washbain tap
 Robinet, aérateur.
 Deck mounted single basin tap, with aerator.

Ref.	€	📦
98449	27,00	24



PANAM urban
LAVE-MAIN / Single washbain tap
 Robinet, aérateur.
 Deck mounted single basin tap, with aerator.

Ref.	€	📦
98458	27,00	48

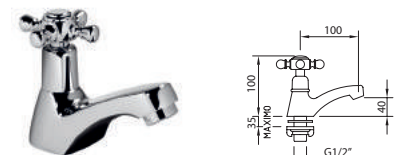

WITH2 antigona
ROBINET SIMPLE 40 / Single tap 40
 Robinet, aérateur.
 Deck mounted single basin tap, with aerator.

Ref.	€	📦
94489	27,00	24

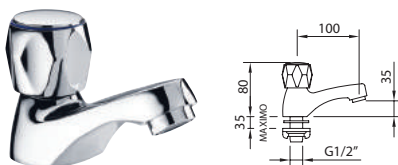
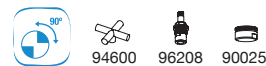

WITH2 guayama
ROBINET SIMPLE 35 / Single tap 35
 Robinet, aérateur.
 Deck mounted single basin faucet, with aerator, cold water indice.

Ref.	€	📦
ACS 96097	27,00	24

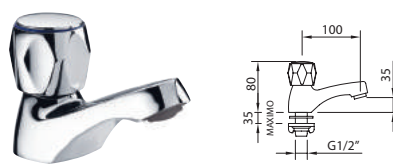

WITH2 guayama GMT
ROBINET SIMPLE 35 / Single tap 35
 Robinet, aérateur.
 Deck mounted single basin faucet, with aerator, cold water indice.

Ref.	€	📦
ACS 99760	28,00	24

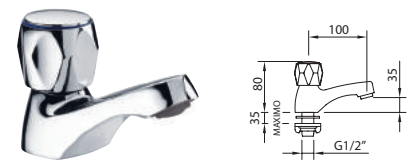

WITH2 guayama G180
ROBINET SIMPLE 35 / Single tap 35
 Robinet, aérateur.
 Deck mounted single basin faucet, with aerator, cold water indice.

Ref.	€	📦
ACS 99787	28,00	24



P.M.R *Medical lever operated devices*

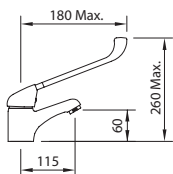

PANAM **urban**

**MITIGEUR LAVABO AVEC
MANETTE MÉDICALE**
Basin mixer with medical lever

Mitigeur lavabo, manette médicale, aérateur, raccords flexibles M-10 3/8" x 370 mm.
Mixer with medical lever operated with aerator, flexible hoses M-10 3/8" x 370 mm.

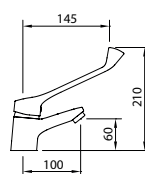

S12 **urban**

**MITIGEUR LAVABO AVEC
MANETTE MÉDICALE**
Basin mixer with medical lever

Mitigeur lavabo, manette médicale, aérateur, raccords flexibles M-10 3/8" x 370 mm.
Mixer with medical lever operated with aerator, flexible hoses M-10 3/8" x 370 mm.

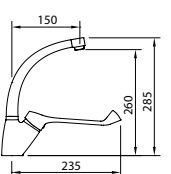

S12 **urban**

**MITIGEUR ÉVIER AVEC
MANETTE MÉDICALE**
Sink mixer with medical lever

Mitigeur évier, manette médicale, bec orientable façonné, aérateur, raccords flexibles M-10 3/8" x 370 mm.
Sink mixer with medical lever operated with aerator, flexible hoses M-10 3/8" x 370 mm.

	Ref.	€	☐
	94694	61,00	12

	Ref.	€	☐
	99214	61,00	8

	Ref.	€	☐
	99215	85,00	8



96256 90760 90025



99217 98237 90025



99217 98237 90025

Barre de sécurité *Safety bar*

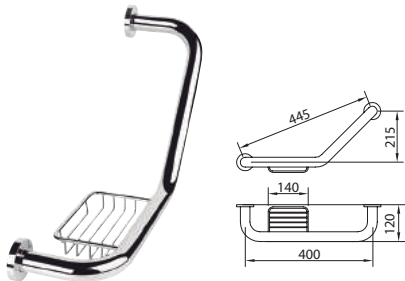

BARRE DE SÉCURITÉ AVEC PORTE-SAVON
Brass chrome security curve handle with soap dish
40cm

Laiton chromé. Kit de fixation inclus.
 Brass chromed. Fixing set included.

Ref.	€	📦
98895	67,00	2

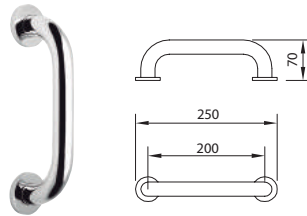

BARRE DE SÉCURITÉ
Brass chrome security curve handle
20cm

Laiton chromé. Kit de fixation inclus.
 Brass chromed. Fixing set included.

Ref.	€	📦
98896	45,00	6

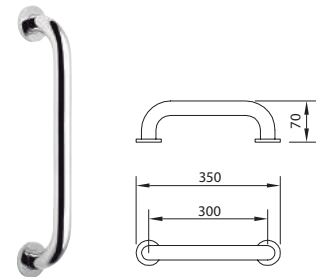

BARRE DE SÉCURITÉ
Brass chrome security curve handle

Laiton chromé. Kit de fixation inclus.
 Brass chromed. Fixing set included.

Ref.	€	📦
98897	50,00	6



PANAM *urban*
MITIGEUR ÉVIER MURAL AVEC MANETTE MÉDICALE
Wall mounted sink mixer with medical lever

Mitigeur évier mural, manette médicale, bec orientable façonné, aérateur.
 Wall mounted mixer with medical lever operated with aerator, flower swivel spout

Ref.	€	📦
ACS 97975	95,00	8

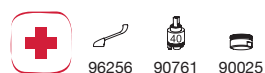

S12 *urban*
MITIGEUR ÉVIER MURAL AVEC MANETTE MÉDICALE
Wall mounted sink mixer with medical lever

Mitigeur évier mural, manette médicale, bec orientable façonné, aérateur.
 Wall mounted mixer with medical lever operated with aerator, flower swivel spout

Ref.	€	📦
ACS 99216	99,00	12

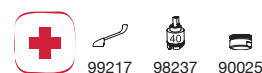

Encastrés iclever Dans toutes les combinaisons

All combinations

LAVABO ENCASTRÉ. Concealed basin mixer

iclever basin

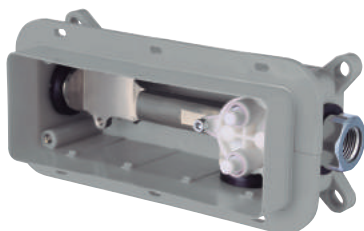

Ref.	€	☐
98703	124,00	6



Instructions d'installation
Instructions installation

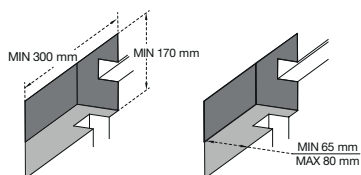

Lavabo encastré / Concealed basin mixer



Instructions lavabo encastré
Instructions concealed basin mixer

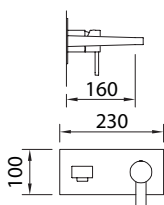

VENTU

99718	216,00	☐ 6
ec3		
99426	98868	98774



BIMINI

98706	141,00	☐ 6
ec3		
95146	98868	98774



PAULA

98708	141,00	☐ 6
ec3		
98215	98868	98774



AGORA *elegance*

98709	141,00	☐ 6
ec3		
95183	98868	98774



ARTIC *xtreme*

98710	141,00	☐ 6
ec3		
95185	98868	98774



CAIMAN *elegance*

98707	141,00	☐ 6
ec3		
95132	98868	98774

* Le prix ne comprend pas la boîte d'encastrement.
Price does not include the concealed box.



99718
Lavabo encastré
Concealed Basin Mixer



Encastrés iclever Dans toutes les combinaisons

All combinations

DOUCHE ENCASTRÉE 1 VOIE.

Concealed bath-shower 1 outlet diverter

iclever 2



Ref.	€	📦
98711	82,00	6



Instructions d'installation
Instructions installation

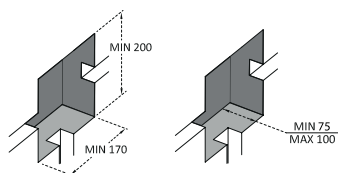

Douche encastrée
Concealed bath-shower



Instructions lavabo encastré
Instructions concealed basin mixer

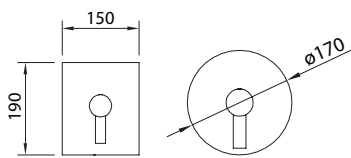

VENTU

99719	135,00	📦 6
-------	--------	-----



BIMINI

98714	98,00	📦 6
-------	-------	-----



PAULA

98716	98,00	📦 6
-------	-------	-----



AGORA *elegance*

98720	98,00	📦 6
-------	-------	-----



AGORA *xtreme*

60746	98,00	📦 -
-------	-------	-----



* Le prix ne comprend pas la boîte d'encastrement.
Price does not include the concealed box.



ARTIC xtreme

98721	98,00		6
ec2			
	95185		97371



CAIMAN urban

98719	98,00		6
ec2			
	96223		97371



ARTIC urban

98717	98,00		6
ec2			
	98240		97371



BAHAMA xtreme

98723	98,00		6
ec1			
	98209		90760



CAIMAN elegance

98715	98,00		6
ec2			
	95132		97371



PANAM urban

98724	93,00		6
ec1			
	95012		90760



CAIMAN xtreme

98718	98,00		6
ec2			
	98212		97371



S12 urban

98725	93,00		6
ec1			
	95174		90760

Combinaisons iclever 2. 1 voie | Combinations iclever 2. 1 outlet diverter

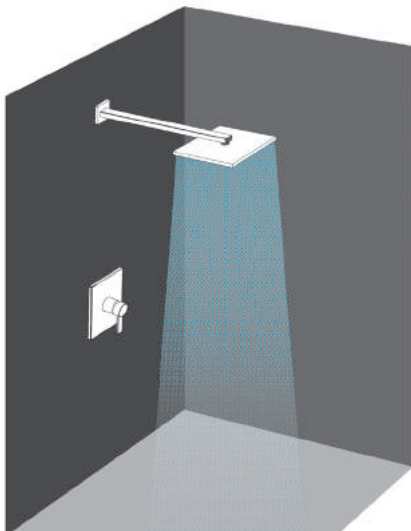

Douche encastrée avec pomme de douche
Concealed shower with Shower head



Douche encastrée avec douchette
Concealed shower with handset



Mitigeur bain encastré
Concealed shower with bath spout

Encastrés iclever Dans toutes les combinaisons All combinations

DOUCHE ENCASTRÉE 2 VOIES.

Concealed bath-shower 2 outlet diverter

iclever 2



Ref.	€	
98711	82,00	6



Instructions d'installation
Instructions installation

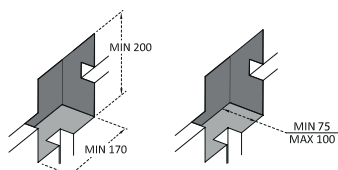

Douche encastrée
Concealed bath-shower



Instructions lavabo encastré
Instructions concealed basin mixer

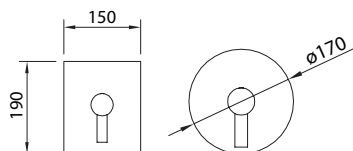

VENTU

99720	156,00		6
		99426	97371



BIMINI

98729	124,00		6
		95146	97371



PAULA

98731	124,00		6
		98215	97371



AGORA *elegance*

98735	124,00		6
		95183	97371



AGORA *xtreme*

60747	124,00		-
		95242	97371

* Le prix ne comprend pas la boîte d'encastrement.
Price does not include the concealed box.



ARTIC xtreme

98736	124,00	6
-------	--------	---

ec2 95185 97371



CAIMAN urban

98734	124,00	6
-------	--------	---

ec2 96223 97371



ARTIC urban

98732	124,00	6
-------	--------	---

ec2 98240 97371



BAHAMA xtreme

98738	124,00	6
-------	--------	---

ec1 98209 90760



CAIMAN elegance

98730	124,00	6
-------	--------	---

ec2 95132 97371



PANAM urban

98739	110,00	6
-------	--------	---

ec1 95012 90760



CAIMAN xtreme

98733	124,00	6
-------	--------	---

ec2 98212 97371



S12 urban

98740	110,00	6
-------	--------	---

ec1 95174 90760

Combinaisons iclever 2. 2 voies
Combinations iclever 2. 2 outlet diverter

Douche / Shower

Bain-douche / Bath-shower

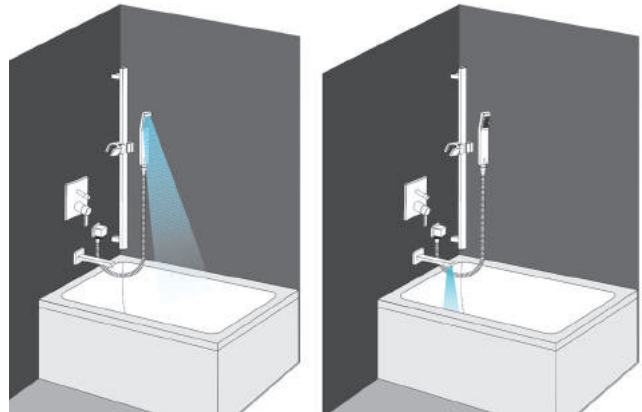
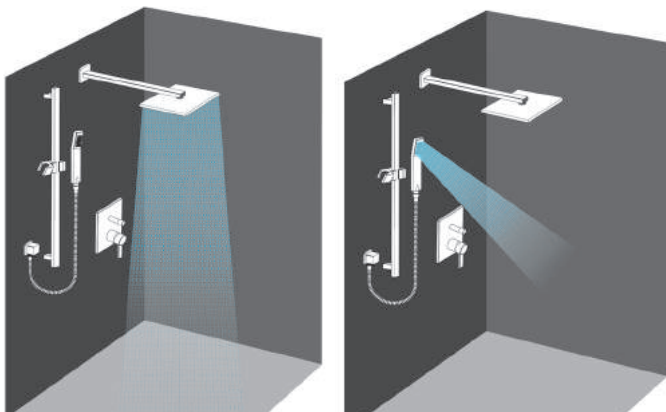

Douche encastrée avec inverseur. Pomme de douche et douchette.
Concealed shower with diverter. Shower head and handset.

Bain-Douche encastrée avec inverseur. Pomme de douche ou douchette et bec.
Concealed bath-shower with diverter. Handset and spout.

Encastrés iclever

Dans toutes les combinaisons
All combinations

DOUCHE ENCASTRÉE 4 VOIES.

Concealed bath-shower 4 outlet diverter

iclever 4



Ref.	€	📦
98742	113,00	6



Instructions d'installation
Instructions installation

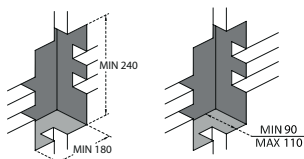

Douche encastrée
Concealed bath-shower



Instructions lavabo encastré
Instructions concealed basin mixer

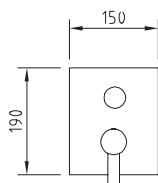

BIMINI

98745 175,00 📦 6

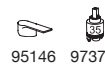

95146 97371



CAIMAN *elegance*

98746 175,00 📦 6



95132 97371



PAULA

98747 175,00 📦 6



98215 97371



AGORA *elegance*

98748 175,00 📦 6

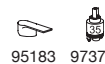

95183 97371



ARTIC *xtreme*

98749 175,00 📦 6



95185 97371



AGORA *xtreme*

60748 175,00 📦 -



95242 97371

* Le prix ne comprend pas la boîte d'encastrement.
Price does not include the concealed box.

Encastrés iclever thermostatique

DOUCHE ENCASTRÉE 3 VOIES.

Concealed bath-shower 3 outlet diverter

iclever 4



Ref.	€	📦
98742	113,00	6



NINE urban

60745 227,00 📦 -

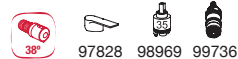

NINE urban

98750 227,00 📦 6

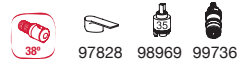

Combinaisons iclever 4. 3 voies.
Combinations iclever 4. 3 outlet diverter

Douche / Shower

Douche encastrée avec dérivateur. Pomme de douche, set de douche ou jets.
Concealed shower with diverter. Shower head, handset or body jets.

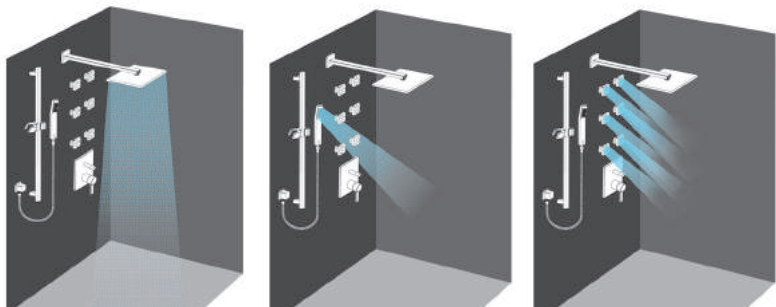

Bain-douche / Bath-shower

Bain-Douche encastrée. Pomme de douche, set de douche, jets et bec.
Concealed bath-shower with diverter. Shower head, handset, body jets or bath spout.

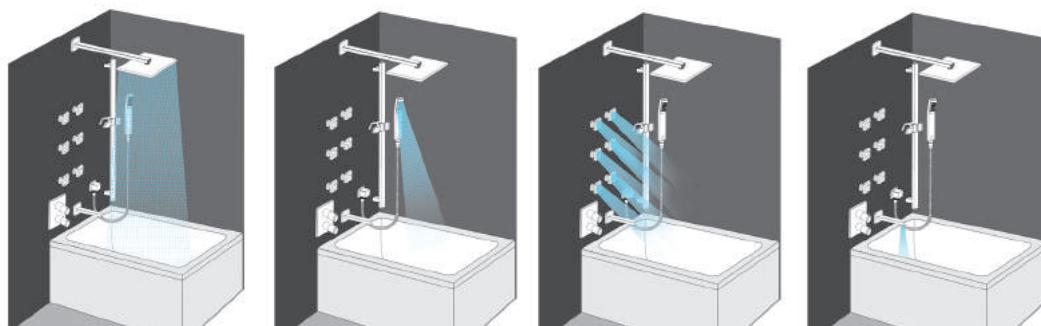

Compléments *Accessories*

Bras de douche | Shower arms

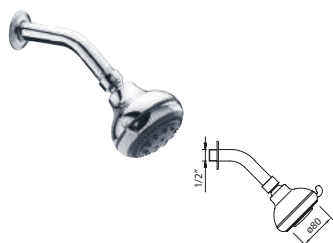

ZANZIBAR Ø80 mm

Avec bras de douche
With shower arm

Ref.	€	📦
ABS 96141	26,00	50

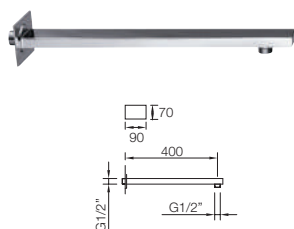

BIMINI 400 mm

Bras pour tête de douche, laiton. Mur.
Shower arm, brass. Wall.

Ref.	€	📦
98000	66,00	15

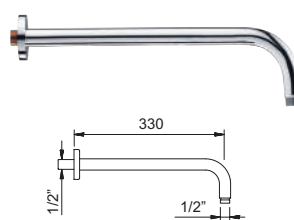

LUZIA 330 mm

Bras pour tête de douche, laiton. Mur.
Shower arm, brass. Wall.

Ref.	€	📦
96153	41,00	50

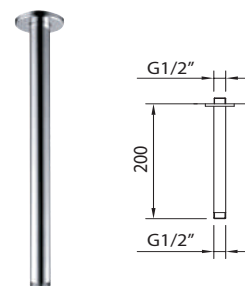

ROOF 200 mm

Bras pour tête de douche, laiton. Toit.
Shower arm, brass. Roof.

Ref.	€	📦
98005	21,00	20

Becs baignoire | Bath spouts

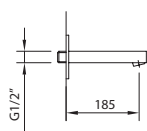

BIMINI 185 mm Bec | Bath spout

Bec mural pour baignoire. Laiton.
Bath wall spout. Brass

Ref.	€	📦
97999	64,00	20

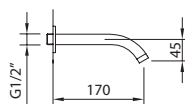

MIKURA 170 mm Bec | Bath spout

Bec mural pour baignoire. Laiton.
Bath wall spout. Brass

Ref.	€	📦
97368	41,00	10

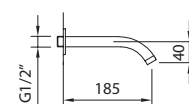

CAIMAN 185 mm Bec | Bath spout

Bec mural pour baignoire. Laiton.
Bath wall spout. Brass

Ref.	€	📦
98004	35,00	20



Sorties flexible | Wall outlets

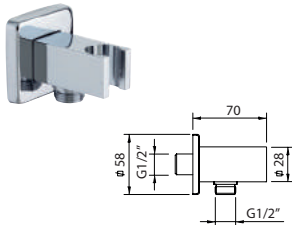

BIMINI

Sortie flexible murale, avec support. Laiton.
Wall hose bib outlet with holder. Brass.

Ref.	€	📦
98235	27,00	20

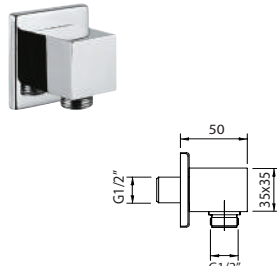

BIMINI

Sortie flexible murale. Laiton.
Wall hose bib outlet. Brass.

Ref.	€	📦
98001	26,00	20

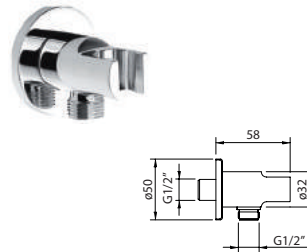

CAIMAN urban

Sortie flexible murale, avec support. Laiton.
Wall hose bib outlet with holder. Brass.

Ref.	€	📦
98236	27,00	10

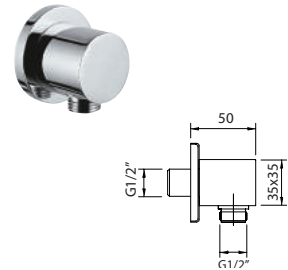

CAIMAN urban

Sortie flexible. Laiton.
Hose bib outlet. Brass.

Ref.	€	📦
97148	26,00	10

Jets | Body jets

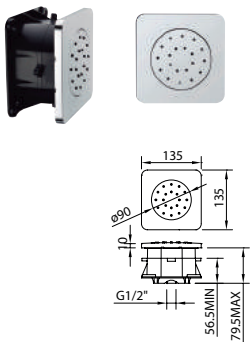

SQUARE 135x135 Jets encastré Concealed body jets

Carré articulé. ABS.
Articulated square. ABS.

Ref.	€	📦
99616	86,00	18

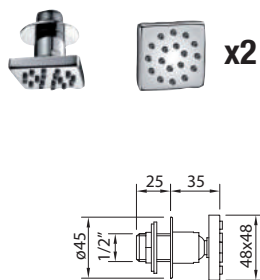

SQUARE 48x48, 6 l/m - 3 bar Jets Body jets

Carré, 2 pièces. Laiton.
Square, 2 pieces. Brass.

Ref.	€	📦
98440	104,00	10



ROUND Ø135 Jets encastré Concealed body jets

Round articulé. ABS.
Articulated round. ABS.

Ref.	€	📦
99617	86,00	18

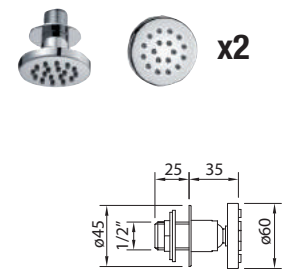

ROUND Ø60, 6 l/m - 3 bar Jets Body jets

Round, 2 pièces. Laiton.
Round, 2 pieces. Brass.

Ref.	€	📦
98441	104,00	10

clever box COLONNE DE DOUCHE THERMOSTATIQUE

Thermostatic shower system

Pratique et attrayant
Attractive and visual



* Ces produits sont conditionnés en Clever Box (Pack indivisible de 4 unités).

These products are provided in Clever Box packaging (Indivisible packaging of 4 units).

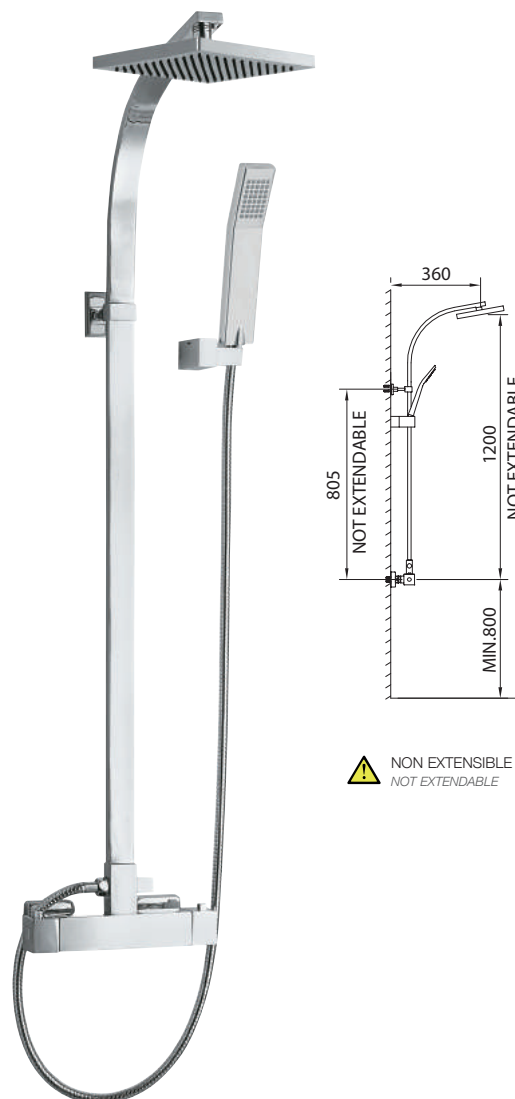

KUADRAT THERM BOX

COLONNE DE DOUCHE THERMOSTATIQUE Thermostatic shower system

Support douchette orientable, inverseur automatique, pomme de douche, douchette et flexible.
 Thermostatic shower valve with automatic diverter.

Inclus
 Includes



Kube
 98672



Marina
 96786



1,75 m
 97670



Saona
 96413

Ref.	€	☐
98671	595,00	4*

Clever Box
 64,5 x 40 x 122 cm



98027



96253

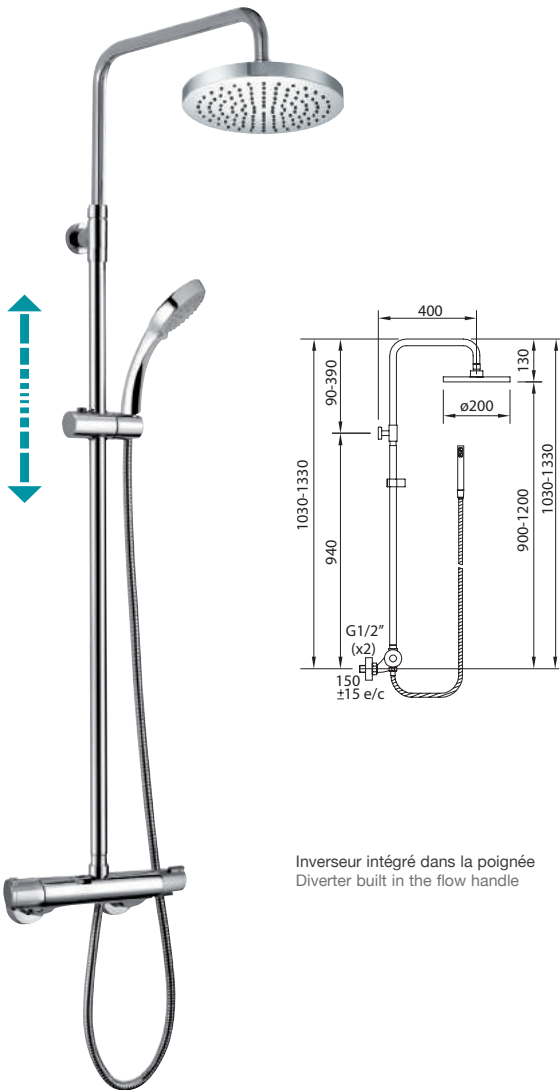

Inverseur intégré dans la poignée
Diverter built in the flow handle

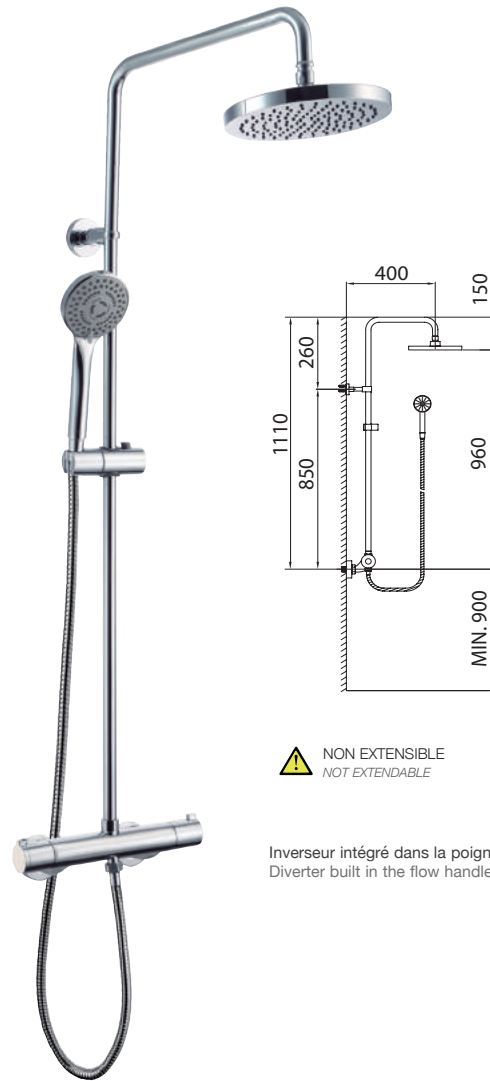

⚠ NON EXTENSIBLE
NOT EXTENDABLE

Inverseur intégré dans la poignée
Diverter built in the flow handle

EXTENSIBLE CIRCULAR THERM BOX

COLONNE DE DOUCHE THERMOSTATIQUE EXTENSIBLE
Adjustable thermostatic shower system

Support douchette coulissant, inverseur céramique, pomme de douche, douchette et flexible.
Adjustable thermostatic shower valve with diverter built in.

Inclus
Includes



CIRCULAR THERM BOX

COLONNE DE DOUCHE THERMOSTATIQUE
Thermostatic shower system

Support douchette coulissant, inverseur céramique, pomme de douche, douchette et flexible.
Thermostatic shower valve with diverter built in.

Inclus
Includes



Ref.	€	📦
60412	420,00	4*

Clever Box
36 x 35 x 92 cm



Ref.	€	📦
60413	389,00	4*

Clever Box
36 x 35 x 92 cm



clever box COLONNE DE DOUCHE MITIGEUR

Shower system

Pratique et attrayant
Attractive and visual



* Ces produits sont conditionnés en Clever Box (Pack indivisible de 4 unités).

These products are provided in Clever Box packaging (Indivisible packaging of 4 units).

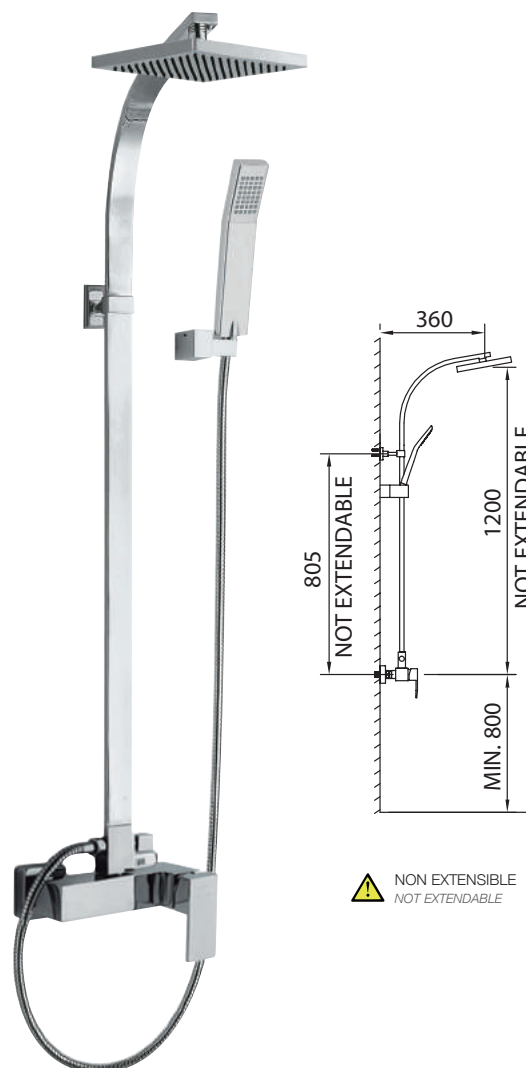

 NON EXTENSIBLE
 NOT EXTENDABLE

KUADRAT MANUAL BOX

COLONNE DE DOUCHE Shower system

Support douchette orientable, inverseur automatique, pomme de douche, douchette et flexible.
 Adjustable shower valve with automatic diverter.

Inclus
 Includes



Kube
 98672

Marina
 96786

1,75 m
 97670

Saona
 96413

Ref.	€	
98850	499,00	4*

Clever Box
 64,5 x 40 x 122 cm



99003



97371



96253

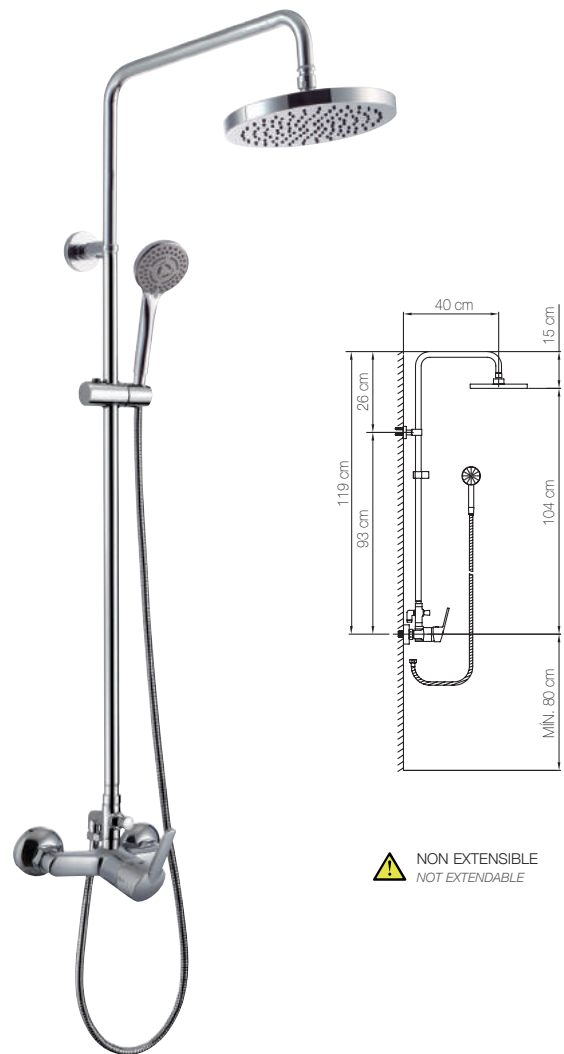
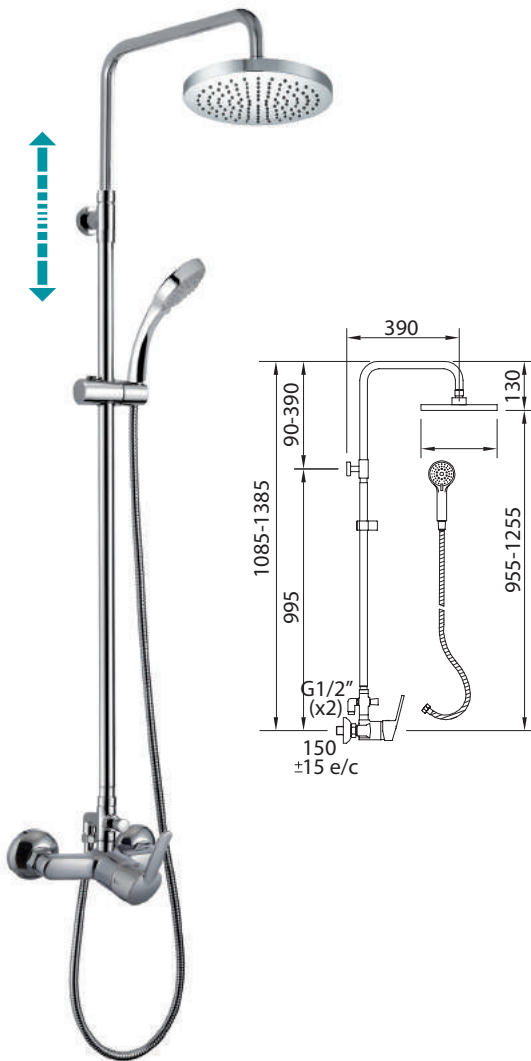

⚠ NON EXTENSIBLE
NOT EXTENDABLE

EXTENSIBLE CIRCULAR MANUAL BOX

COLONNE DE DOUCHE EXTENSIBLE
Adjustable shower system

Support douchette coulissant, inverseur automatique, pomme de douche, douchette et flexible.
Adjustable shower valve with automatic diverter.

Inclus
Includes



CIRCULAR MANUAL BOX

COLONNE DE DOUCHE
Shower system

Ensemble de douche, pomme de douche supérieure articulée, douchette et flexible.
Adjustable shower valve with automatic diverter.

Inclus
Includes



Ref.	€	📦
98527	320,00	4*

Clever Box
36 x 35 x 92 cm

Ref.	€	📦
99142	289,00	4*

Clever Box
36 x 35 x 92 cm



95175 98237



96175 98237

Encastré iclever box MITIGEUR Pratique et attrayant Single lever. Attractive and visual



Clever Box 59 x 32 x 12 cm

START xtreme

Box mitigeur de douche encastré 2 voies complet
Concealed shower single lever mixer 2 ways

Ref.	€	📦
60694	295,00	4*

*Pack indivisible de 4 unités
*(Indivisible Packaging of 4 units)

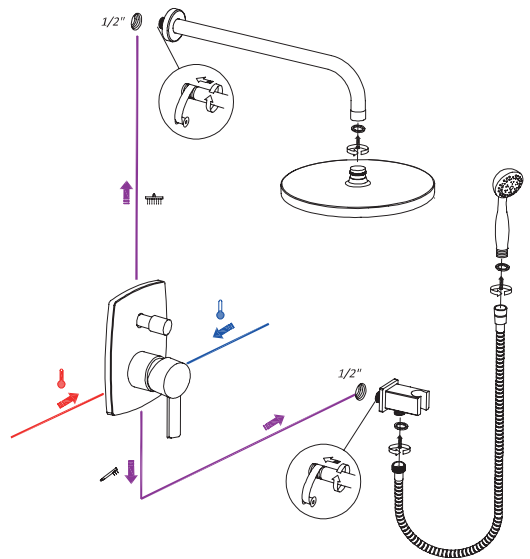

Inclus
Includes

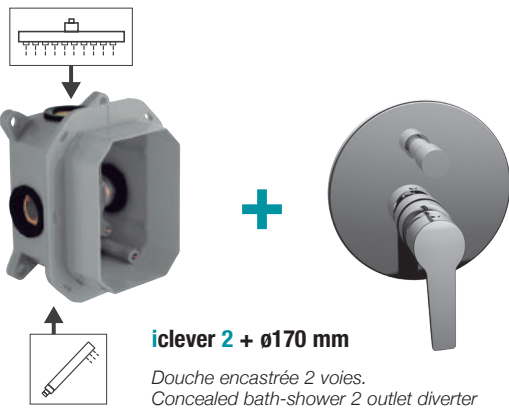

iclever 2 + ø170 mm
Douche encastrée 2 voies.
Concealed bath-shower 2 outlet diverter



Slim INOX AIR ø250 mm 99690
1 Fonction | 1 Function



Luzia 330 mm 96153



1,75 m 97670



Bimini 98236



City AIR ø100 mm ABS 99615

3 Fonctions | 3 Functions



Instructions d'installation
Instructions installation

clever

G R I F F E R Í A



Accessoires Box *Box Accessories*



Douchette SYVARI 3F Ø100mm
Handset SYVARI

Ref.	€	Icon
ACS 98885	17,50	16'

*Pack indivisible de 16 unités)
*(Indivisible Packaging of 16 units)

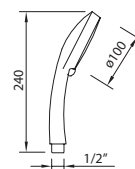

Flexible SilverHose 1,75 m
SilverHose Flexible

Ref.	€	Icon
98881	22,00	10'

*Pack indivisible de 10 unités)
*(Indivisible Packaging of 10 units)

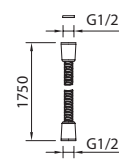

Ensemble barre de douche SYVARI 3F
Shower Set SYVARI

Ref.	€	Icon
ACS 98886	64,00	12'

*Pack indivisible de 12 unités)
*(Indivisible Packaging of 12 units)

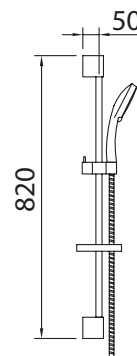



42,5 cm
38 cm
74,5 cm

**Box 4 Accessoires de bain
4 Accessories bath box**

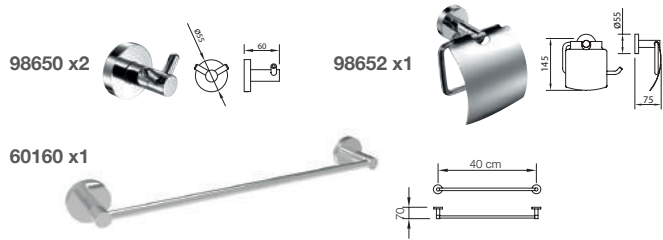

Ref.	€	☐
99450	95,00	8*

*(Pack indivisible de 8 unités)
*(Indivisible Packaging of 8 units)



29,5 cm
22,5 cm
38 cm

**LEO BOX
Vidage quick-clac metal 1-1/4"
Pop-up quick-clac metal 1-1/4"**



Ref.	€	☐
60418	14,00	24*

*(Pack indivisible de 24 unités)
*(Indivisible Packaging of 24 units)

**CIRCULAR KIT SHOWER BOX
COLONNE DE DOUCHE | Shower bar set**



36 cm
35 cm
92 cm

Inclus
Includes

- Circular 98518
- Syvari 3F 98884
- 1,75 m 97670
- 0,35 m 97396
- Support 98998
- Kit box 99172
- ø20 98997

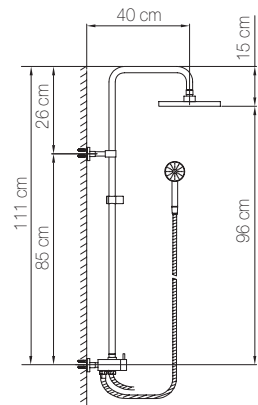
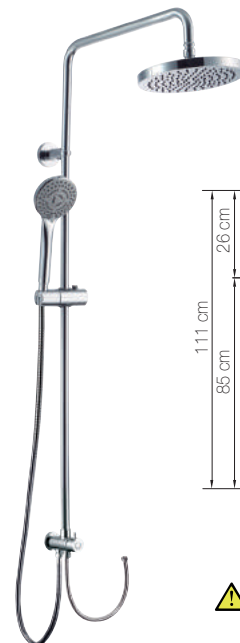

**⚠ NON EXTENSIBLE
NOT EXTENDABLE**

Ref.	€	☐
99136	223,00	4*

*(Pack indivisible de 4 unités)
*(Indivisible Packaging of 4 units)



Présentoirs de comptoir

Display stand over-table



CLEVER KITCHEN

PRÉSENTOIR CUISINE

Kitchen faucet display stand over-table

Robinetterie non comprise
Faucets not included

Ref.	€	
95821	186,00	1

Configurations possibles
Possible configurations



Ref.	€	
95821	186,00	1
95666	54,00	1

Présentoir 1

Display



Ref.	€	
95821	186,00	1
95829	54,00	1

Présentoir 2

Display

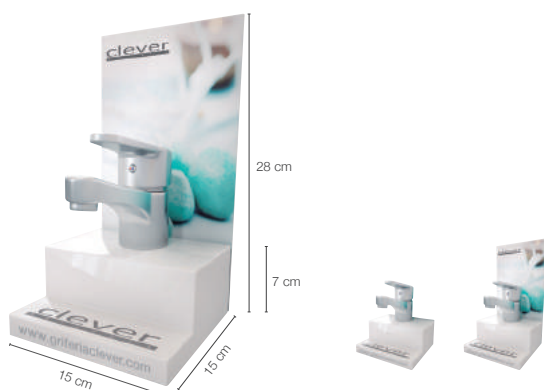

CLEVER ONE

PRÉSENTOIR ROBINETTERIE AVEC PANNEAU AIMANTÉ

Faucet display stand over-table with billboard magnetised

Robinetterie non comprise
Faucets not included

Configurations possibles avec/sans panneau
Possible configurations, with or without billboard

Ref.	€	
95717	33,00	1

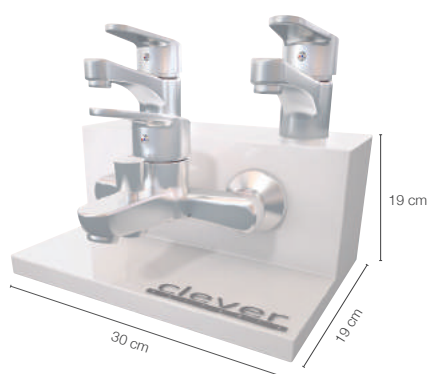

CLEVER MINI

PRÉSENTOIR ROBINETTERIE

Faucet display stand over-table

Robinetterie non comprise
Faucets not included

Vinyle aimanté APP Clever compris.
Magnetized vinyl APP Clever included.



(9x9cm)

Ref.	€	
95540	97,00	1

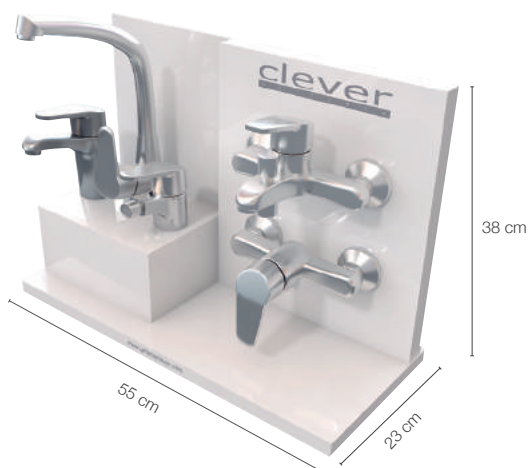

CLEVER FIVE
PRÉSENTOIR ROBINETTERIE
Faucet display stand over-table

Robinetterie non comprise
 Faucets not included

Ref.	€	
95753	181,00	1

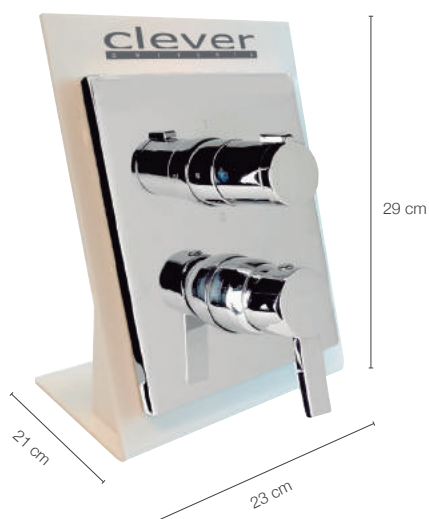

iCLEVER
PRÉSENTOIR iCLEVER
iclever display stand over-table

Robinetterie non comprise
 Faucets not included

Ref.	€	
95754	67,00	1



CLEVER SHATTAF
PRÉSENTOIR DOUCHETTE HYGIÉNIQUE
Shattaf display stand over-table

Robinetterie non comprise
 Faucets not included

Ref.	€	
95755	78,00	1

Présentoir Clever Maxi

Clever maxi display

CLEVER MAXI. Personnalisez-les à votre goût

Clever maxi. Customize it as you want



95749
Support pour évier avec
douchette extractible
Pull-out sink mixersupport



95668
Support pour lavabo, bidet
ou évier
Support for basin, bidet or sink



95756
Double support pour lavabo,
bidet ou évier
Double support for basin, bidet or sink



95669
Support pour bain-douche ou
douche
Support for bath-shower or shower



95663
Pièce blanche
White piece



95670
Support en bois pour
douchettes
Wood Holder for handshower



95824
Support pour douchettes
Support for handshower



95832
Support double pour Nine Elegance et Nine Xtreme
 Double support for Nine Elegance and Nine Xtreme



95828
Support double en bois
 Double wood Holder

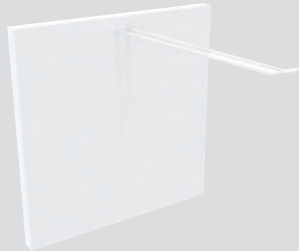

95839
Support avec un crochet
 Support with one hook



95840
Support avec deux crochets
 Support with two hooks



95837
Plateau simple
 Simple tray
 30 x 30 x 27 cm

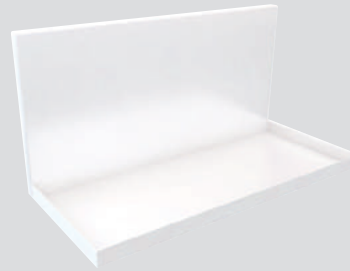

95838
Plateau double
 Double tray
 30 x 60 x 27 cm

Ref.	€	📦
95667	538,00	1
95749	38,00	1
95668	33,00	1
95756	41,00	1
95669	33,00	1
95663	22,00	1
95670	43,00	1

Ref.	€	📦
95824	54,00	1
95832	93,00	1
95828	93,00	1
95839	41,00	1
95840	43,00	1
95837	52,00	1
95838	93,00	1



Présentoir Clever Maxi Clever maxi display

Décorer votre Clever maxi
Decorate your Clever maxi



95671
Image de fond
(utilisation recommandée lorsque le
présentoir n'est pas contre le mur)
Rear image
(recommended use when the display is not placed
against the wall)



95664
Vinyle aimanté. Ambiance douche
Magnetized vinyl. Shower Image



95665
Vinyle aimanté. Ambiance bain
Magnetized vinyl. Mixer Image



95666
Vinyle aimanté. Ambiance cuisine
Magnetized vinyl. Sink Image



95829
Vinyle aimanté. Image carrelage mural
Magnetized vinyl. Tiles image



95806
Vinyle aimanté. Ambiance hydroclever
Magnetized vinyl. Hydroclever image

Ref.	€	
95671	72,00	1
95664	57,00	1
95665	54,00	1
95666	54,00	1
95829	54,00	1
95806	54,00	1

Facile à assembler

Easy to assemble



Présentoir Clever Maxi Clever maxi display

CLEVER MAXI. Configurations possibles
Clever maxi. Possible configurations

Présentoir / Display 1



Présentoir / Display 2



Présentoir / Display 3



Présentoir / Display 4



Présentoir / Display 5



Présentoir / Display 6



Présentoir / Display 7



Présentoir / Display 8



Présentoir / Display 9



Présentoir / Display 10



Présentoir / Display 11



Présentoir / Display 12



	Inclus																		
	95667	95668	95669	95670	95663	95749	95756	95832	95828	95824	95839	95840	95837	95638	95664	95665	95666	95829	95606
Présentoir 1	1	8																	
Présentoir 2	1	4	4																
Présentoir 3	1		2	2	4														
Présentoir 4	1	1	3	1	2		1												
Présentoir 5	1	2	2		4											1		1	
Présentoir 6	1	1	1		4	2											1	1	
Présentoir 7	1				4			1	1										
Présentoir 8	1				4			1	1										1
Présentoir 9	1		1				2			1	1	2	1						
Présentoir 10	1	1	1							1	1	1		1					
Présentoir 11	1		2	2	4														
Présentoir 12	1	2	2	4															

Vidages Pop-up

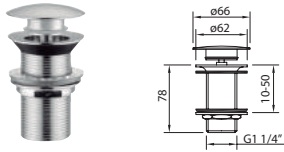

VELA
VIDAGE QUICK-CLAC
Basin click waste

Pour lavabo et bidet avec trop-plein. Métallique
Without overflow. Metallic

Pour lavabo et bidet avec trop-plein. Métallique
With overflow. Metallic

Ref.	€	📦
97395	18,00	50
96255	18,00	50

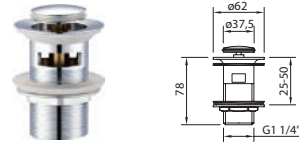

ORION
VIDAGE QUICK-CLAC
Basin click waste

Pour lavabo et bidet avec trop-plein. Métallique
Without overflow. Metallic

Ref.	€	📦
96254	18,00	50

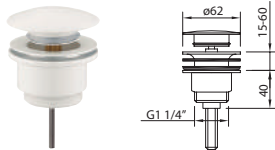

LEO BLANCO MATE
VIDAGE QUICK-CLAC
Basin click waste

Vidage Universel. Métallique.
Universal drain quick-clac. Metallic

Métallique
Metallic

 **Blanc**
White

Ref.	€	📦
60701	16,00	-

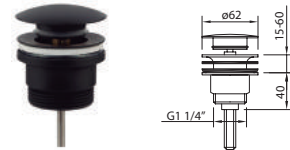

LEO NEGRO MATE
VIDAGE QUICK-CLAC
Basin click waste

Vidage Universel. Métallique.
Universal drain quick-clac. Metallic

Métallique
Metallic

 **Noir**
Black

Ref.	€	📦
60702	16,00	-

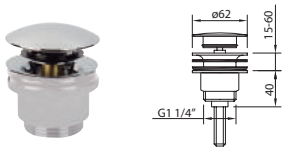

LEO
VIDAGE QUICK-CLAC
Basin click waste

Vidage Universel. Synthétique. 1 1/4".
Universal drain quick-clac. Synthetic 1 1/4"

Ref.	€	📦
 60558	12,00	50

Synthétique
Synthetic



LEO
VIDAGE QUICK-CLAC
Basin click waste

Vidage Universel. Métallique.
Universal drain quick-clac. Metallic

Métallique
Metallic

Ref.	€	📦
98674	15,00	1

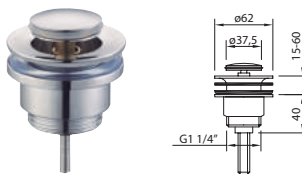

LYNX
VIDAGE QUICK-CLAC
Basin click waste

Vidage Universel. Métallique.
Universal drain quick-clac. Metallic

Ref.	€	📦
98673	14,00	50

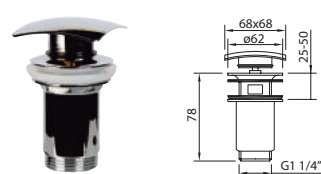

HYDRA
VIDAGE QUICK-CLAC LAITON
Basin click waste

Vidage Universel. Métallique.
Universal drain quick-clac. Metallic

Ref.	€	📦
98675	18,00	50



MÉTALLIQUE
Metallic - Pop-up waste

Vidage automatique 1 1/4" pour lavabo/bidet.
Pop-up 1 1/4" for basin and bidet.

Ref.	€	📦
 99127	15,00	50

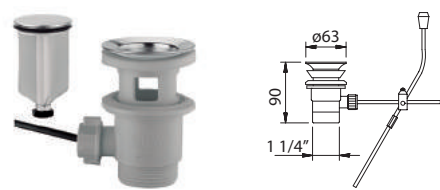

SYNTHÉTIQUE
Synthetic - Pop-up waste

Vidage automatique 1 1/4" pour lavabo/bidet.
Pop-up 1 1/4" for basin and bidet.

Ref.	€	📦
92901	5,50	50
 99130	8,50	50

Siphons Siphons

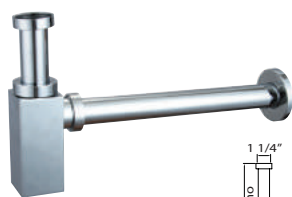

xtreme
SIPHON LAITON
Brass bottle trap

Siphon 1 1/4" de luxe pour vasques à encastrer, longueur de tube latéral 300 mm, longueur de tube vertical 150 mm, tube de 32 mm Ø.

Luxury square bottle trap 1 1/4" for basin, lateral tube 300 mm long, vertical tube length, 150 mm. Tube 32 mm Ø.

Ref.	€	📦
96173	52,00	10



elegance
SIPHON LAITON
Brass bottle trap

Siphon 1 1/4" de luxe pour vasques à encastrer, longueur de tube latéral 300 mm, longueur de tube vertical 150 mm, tube de 32 mm Ø.

Luxury square bottle trap 1 1/4" for basin, lateral tube 300 mm long, vertical tube length, 150 mm. Tube 32 mm Ø.

Ref.	€	📦
96174	43,00	10



urban
SIPHON LAITON
Brass bottle trap

Siphon 1 1/4" de luxe pour vasques à encastrer, longueur de tube latéral 300 mm, longueur de tube vertical 150 mm, tube de 32 mm Ø.

Bottle bottle trap 1 1/4" for basin, lateral tube 300 mm long, vertical tube length, 150 mm. Tube 32 mm Ø.

Ref.	€	📦
90755	23,00	10

Robinetets d'équerre Angle valves



DESIGN
ROBINET D'ÉQUERRE
Angle valve

Laiton chromé.
Tête céramique 1/4 de tour.
Brass chrome. Ceramic disc.

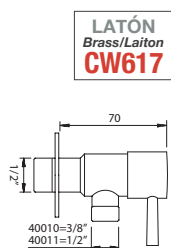

LATÓN
Brass/Laiton
CW617

	Ref.	€	📦
1/2" x 3/8"	40010	13,00	100
1/2" x 1/2"	40011	13,00	100



BIMINI
ROBINET D'ÉQUERRE
Angle valve

1/2" x 3/8"

Laiton chromé.
Tête céramique 1/4 de tour.
Brass chrome. Ceramic disc.

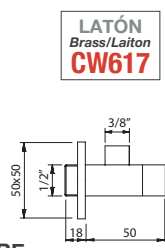

LATÓN
Brass/Laiton
CW617

Ref.	€	📦
97106	17,00	60



MINAMI
ROBINET D'ÉQUERRE
AVEC FILTRE
Angle valve with filter

1/2" x 3/8"

Laiton chromé.
Tête céramique 1/4 de tour.
Brass chrome. Ceramic disc.

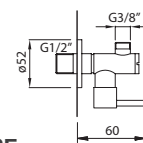

Ref.	€	📦
97107	17,00	90

Colonettes Bath legs



xtreme
COLONETTES
Bath legs

Ref.	€	📦
99804	70,00	-



elegance
COLONETTES
Bath legs

Ref.	€	📦
99803	63,00	-



COLONETTES
Bath legs

Colonettes excentrées
3/4" x 3/4" (2 unités).
Extensions 3/4" x 3/4"
(2 units). Not Mikura, not
Marina.

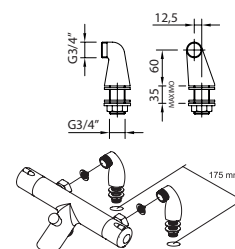

Ref.	€	📦
96292	43,00	10

Pièces de rechange Spare parts

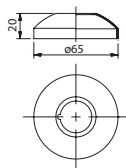

ROSACE Flange

Métal chromé (2 pièces)
Chromed metal (2 pieces)

Ref.	€	📦
95043	4,00	10

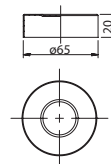

ROSACE Flange

Rosace (2 pièces).Chromé
Flange (2 pieces).Chromed

Ref.	€	📦
96238	6,00	10

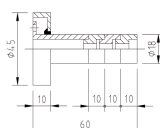

SUPPORT MURAL Wall support

Support mural.
Wall support for shower set.

Ref.	€	📦
ø 25 98497	16,00	10
ø 20 98998	13,00	10

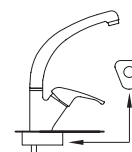

RENFORT ROBINET ÉVIER Reinforcement sink

ABS
Universal
ø35



Ref.	€	📦
97688	2,25	90

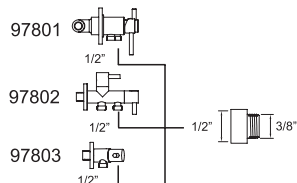

SHATTAF RÉDUCTEUR DE CONNEXION Reducer connection

Laiton chromé
Brass chromed

1/2"H x 3/8"M
1/2"F x 3/8"M

Ref.	€	📦
97825	3,75	20

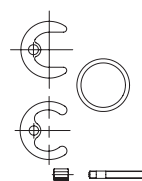

SET DE FIXATION Fixing set

Set de fixation (lavabo, bidet, évier).
Fixing set rim mounted faucets (basin, bidet, sink).

96267: Largo - Long / 110mm
95040: Universal

Ref.	€	📦
96267	6,50	20
95040	2,75	20

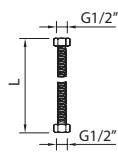

FLEXIBLE Flexible

Ecrous hexagonaux pour 99136.
Flexible with 2 hexagonal nuts for 99136.

97396: L=35 cm Inox, stainless steel
97397: L=60 cm Inox, stainless steel

Ref.	€	📦
97396	3,75	24
97397	6,00	50

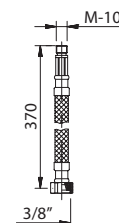

RACCORDS FLEXIBLES Flexible connections

99862/98666: M-10 x 370 mm x 3/8"
DN6
EPDM 



Ref.	€	📦
98666	2,75	250

98667: M-10 x 370 mm x 3/8"
DN6
PEX

98667	2,75	250
-------	------	-----

98986: M-10 x 420 mm x 3/8"
DN6
EPDM

98986	2,75	250
-------	------	-----

96243: M-10 x 370 mm x 3/8"
DN8
EPDM

96243	2,75	250
-------	------	-----

98994: M-10 x 420 mm x 3/8"
DN8
EPDM 

98994	3,63	100
-------	------	-----





F C H



**INDEX
Indice**

ABS

	Ref.	€	📦
Antigona F	95044	2,25	10
Antigona C	95045	2,25	10
Antigona H	95046	2,25	10
	Ref.	€	📦
Universal	97363	1,25	10



**ADAPTATEUR
Adapter**

Adaptateur tubo PE 1/4" - 7/16"-24 H (pour 97104, 97806, 98760, 60150, 60151, 99684).
Adapter for PE 1/4" - 7/16"-24 F pipe (for 97104, 97806, 98760, 60150, 60151, 99684).



	Ref.	€	📦
	97399	7,00	10

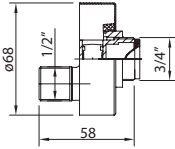

**Vanne excentrique On/Off +
filtre + rosace
Eccentric nut On/Off valve +
filter + flange**

	Ref.	€	📦
	98647	39,00	2

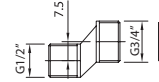

**Excentré
Eccentric nut**

95042: Universal
96299: Avec silencieux
With noise reduction



	Ref.	€	📦
	95042	7,50	25
	96299	9,50	10

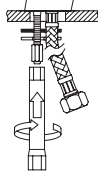

**OUTIL DE DÉMONTAGE ENSEMBLE DE FIXATION
Dismantling tool for fixation set**

Hexagonal 11

	Ref.	€	📦
	98751	3,75	1



**OUTIL DE DÉMONTAGE AÉRATEUR
Dismantling tool for aerator**

Universal M-28-M24-M22

	Ref.	€	📦
	98752	3,75	1



ANTIGONA

**INVERSEUR
Diverter**

Inverseur manual.
Diverter for bath-shower.

	Ref.	€	📦
	95051	13,00	20



ANTAO

**INVERSEUR
Diverter**

Inverseur Antao.
Diverter for shower set with tube.

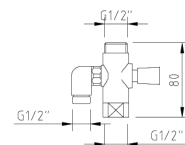

	Ref.	€	📦
	96120	40,00	20



Pièces de rechange Spare parts

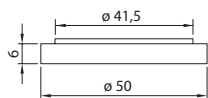

BASE EN PLASTIQUE S12 / START
Plastic base

ABS
Ø50

Ref.	€	
60559	1,90	-

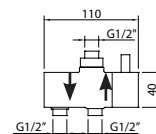

KIT BOX

INVERSEUR
Diverter

Inverseur pour 99136/99623
Diverter for 99136/99623



Ref.	€	
99172	40,00	-

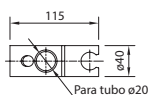

BASIC BOX

SUPPORT COULISSANT ARTICULÉ
Articulated holder

BASIC BOX
Pour tube ø20.
CEILAN
Pour tube ø25.

Ref.	€	
98997	15,00	20
96264	21,00	20

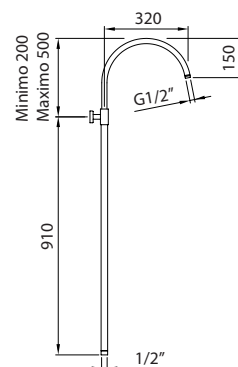

CROSS Ø25

Barre extensible. Laiton chromé
Adjustable tube for shower set. Brass chromed

Ref.	€	
96118	191,00	4

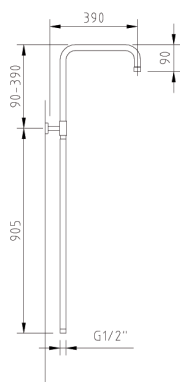

CIRCULAR Ø25

Barre extensible. Laiton chromé.
Adjustable tube for shower set.
Brass chromed

Ref.	€	
98517	191,00	4

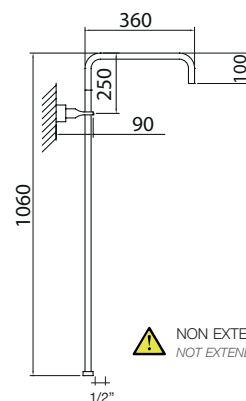

NON EXTENSIBLE
NOT EXTENDABLE.

BASIC BOX

Barre. Inox chromé.
Tube for shower set.
Stainless steel chromed

Ref.	€	
98996	124,00	20



Information technique

Technical information

¿Que signifie chaque certification?

What's the meaning of each certification?

1 Adhésion du recouvrement sur les matériaux plastiques, choc thermique. Lining adhesion on plastic materials, thermal shock.

Test d'adhésion du chrome sur les éléments plastiques de la robinetterie par choc thermique.

Testing the Chrome adhesion on the plastic materials by thermal shocks.

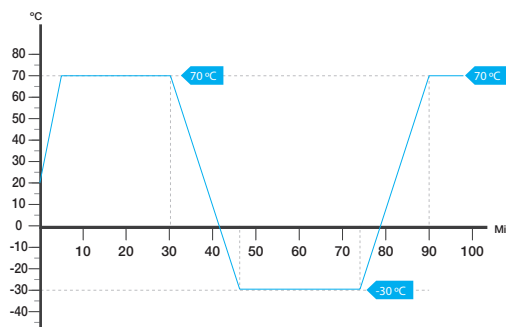

2 Résistance au brouillard salin Resistance. Salt spray test

Test de durabilité de la surface chromée des éléments métalliques par exposition de 200 h à un brouillard salin.

Test the Chrome resistance surface on the metallic materials by checking them on the salt spray test during 200 hours.

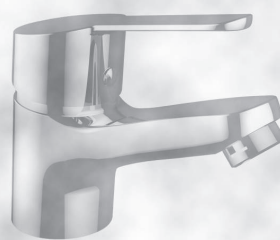

200h
5% Sel
Salt

Solution saline 64 sur
5% NaCl.
Saline 64 with 5% NaCl

3 Durabilité mécanique Mechanic Duration

Test d'endurance mécanique des éléments mobiles, cartouches, becs et inverseurs.

Test the duration of the mechanical moving parts by cycles on the cartridges, spouts and diverters.



EN817

ECAU₃



Cartouche/ Cartridge

70.000

Bec / spout

80.000

Inverseur / diverter

30.000

Cartouche/ Cartridge

175.000

Bec / spout

200.000

Inverseur / diverter

80.000

4 Résistance à la pression Resistance on the pressure

Test de résistance à la pression en soumettant l'ensemble cartouche/robinet pendant une période de temps déterminé à certaines pressions.

Test the pressure resistance subjecting the cartridge and the mixers during a certain time to a particular pressure.



Temps / Time

60s

Pression / Pressure

25 bars

Répétitions / Repetitions

100

Pression / Pressure

50 bars



L'excellence dans le processus de fabrication

The excellence in the manufacturing process

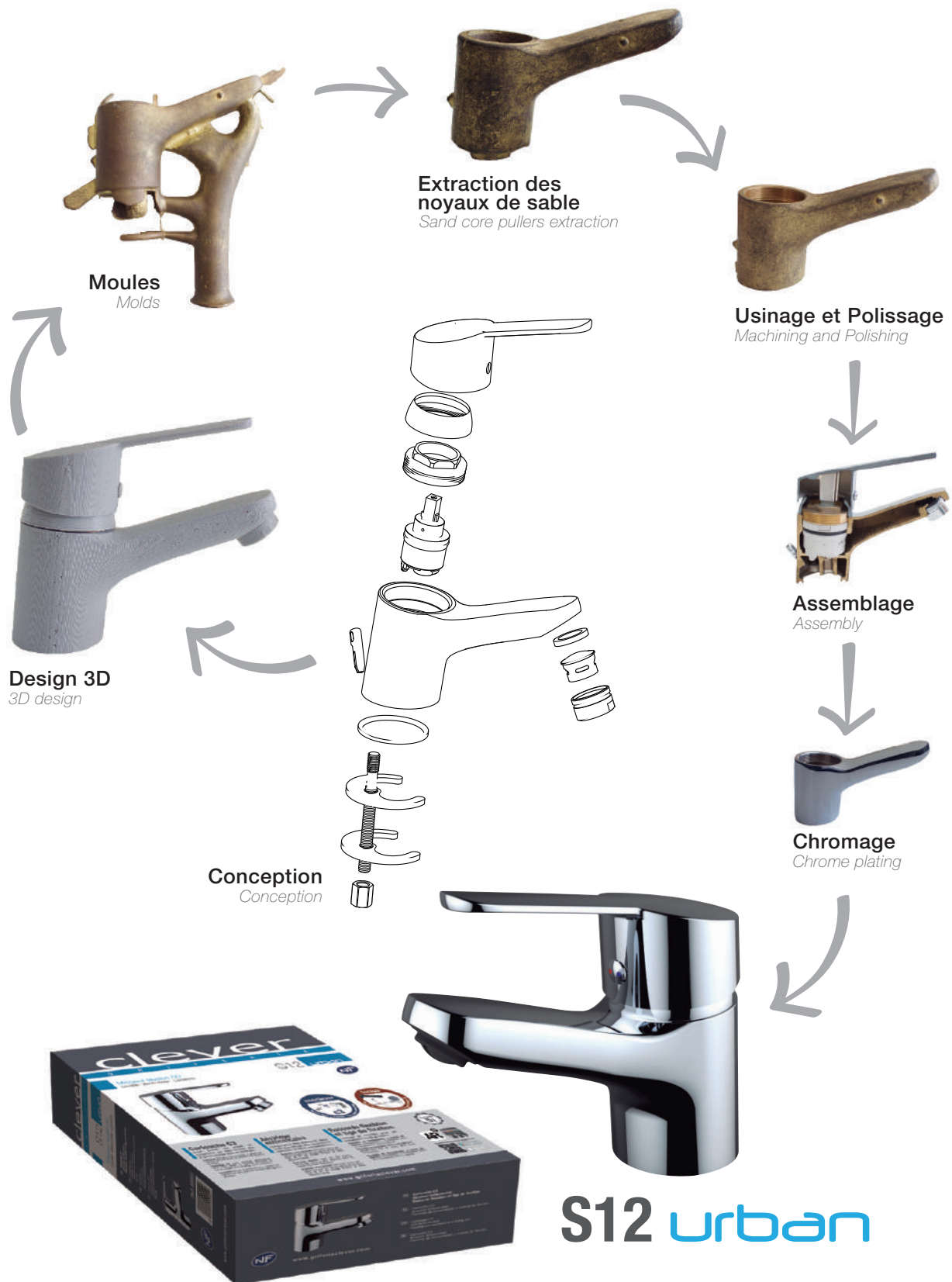

La technologie la plus avancée dans les robinets

The most advanced technology in taps and showers

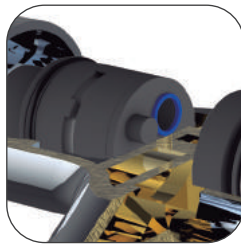

Cartouche dérivateur céramique
Ceramic cartridge distributor

gitec

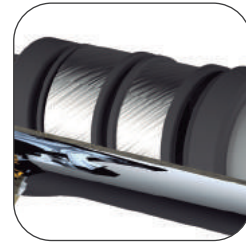

Cartouche thermostatique
(Norme EN 1111)
Thermostatic cartridge (EN 1111)

Vernet

cosedal
THE FAUCET'S HEART

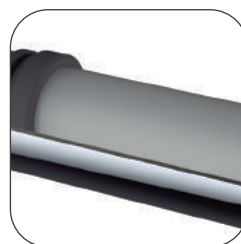

Système Cold Touch breveté
Cold Touch system patented



Le processus de chromage comprend 44 étapes pour une résistance maximale à la corrosion

Chroming process comprising 44 steps, high corrosion resistance

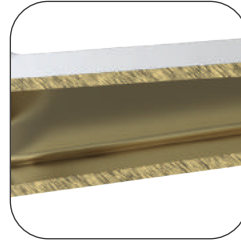

Faible pourcentage de plomb
60% Cu + -0,5. Pb <1,6%

*Low percentage of lead
60% Cu + -0.5. Pb <1.6%*

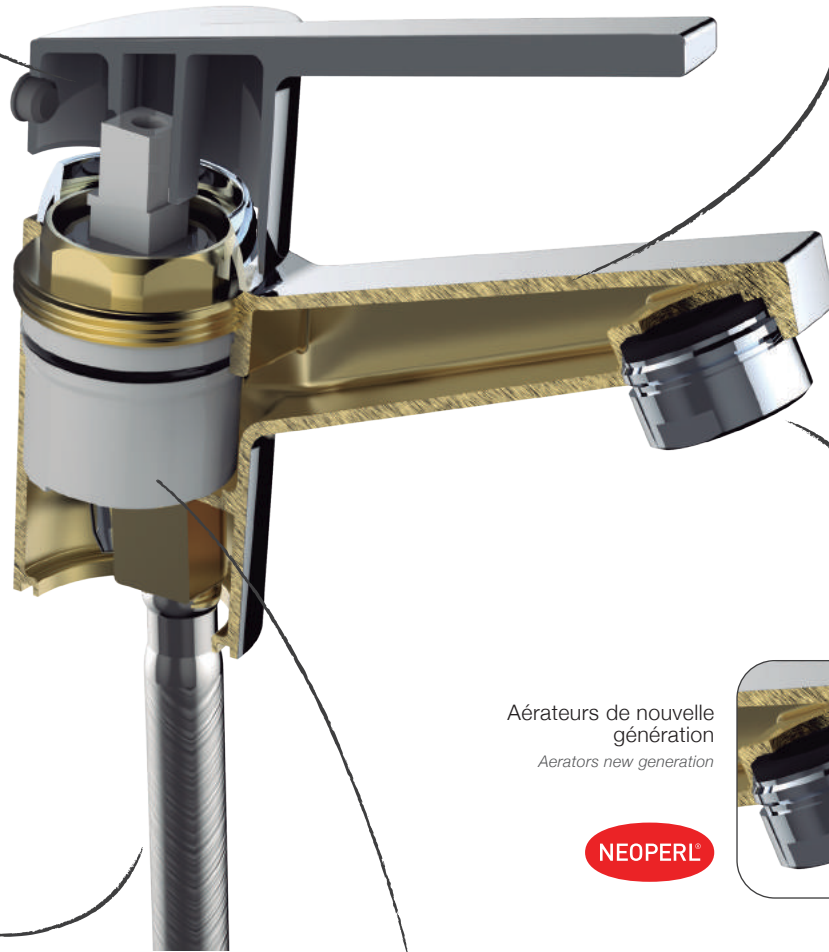

Aérateurs de nouvelle génération
Aerators new generation

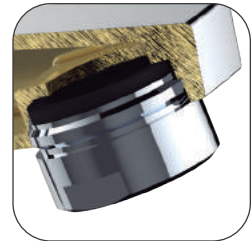

EPDM / PEX. Certification AENOR et CSTBat.
(Norme ENE EN 13618)

*EPDM / PEX. AENOR and CSTBat certification.
(UNEEN 13618)*



Cartouches céramiques de grande précision.
(Norme UNE EN 817)

*Ceramic cartridges with highly precision.
(UNE EN 817)*



Information technique Technical information

LAITON · BRASS

FONTE · CAST



La robinetterie CLEVER est fabriquée à partir d'alliages purs contenant un niveau d'impuretés minimum. Le pourcentage de plomb utilisé est très faible (Pb<1,6%) dans le respect des exigences pour la consommation d'eau potable. Les alliages sans aucun pore permettent un polissage de haute qualité, sans fissure.

Clever taps use pure alloys, with a minimum impurity quantity. The percentage of lead is really low (Pb<1,6%) according to the strictest market requirements. The alloy exempts of pores allows to obtain a high quality polish. Total breaks Absence.

ESTAMPÉE · STAMPING



Laiton européen de première qualité estampé par extrusion. Norme UE-EN 12,164/5.

Le laiton estampé contient un haut pourcentage de cuivre (Cu ~60%) et un très faible pourcentage d'étain (Sn<0,3%) évitant la rigidité et les risques d'endommagement.

High quality European stamping Brass. According rule UE EN 12.164/15. The stamping brass has a high percentage of Cooper (Cu~60%). Very low percentage of Tin (Sn<0,3%), avoids rigidity and possible damages.

COMPOSANTS · COMPONENTS

FLEXIBLES D'ALIMENTATION · HOSE BIBS



Longueur minimum de 370 mm selon la Norme EN 817. Embouts en laiton CW617 (Sn<0,3%). Tressage en acier inoxydable AISI 304. Tuyaux en caoutchouc EPDM ou PEX, sans risque de migration de particules nocives. Résistance à des pressions statiques de plus de 130 bar (13MPa). Nombreuses certifications internationales.

Length 370 mm according to the rule EN 817. Male nut produced with CW617 (Sn<0,3%). Braided stainless steel AISI 304. Rubber tube EPDM or PEX, avoiding any particles migration. All worldwide certifications. They resist static pressures higher than 130 bars (13MPa).

AÉRATEURS · AERATORS



Protection maximale contre les dépôts calcaire. Longue durée de vie. Permettent la réduction des éclaboussures et un écoulement de l'eau droit et cylindrique, indépendamment du débit. Réduisent le niveau sonore, permettent une économie d'eau et réduisent le coût énergétique.

Maxim protection against lime residues. Long life. Splashes reduction. Flow straight control and water stream diameter. It produces a straight flow, round, independent to the pressure. Minimum noise level. It allows water save and electricity cost reduction.

CHROMAGE · CHROMED



Extra chromage, procédé de chromage en 44 étapes qui garantit la résistance à la corrosion.
La surface doit supporter un test en laboratoire consistant à résister à plus de 200 heures de brouillard salin sans dégradation.

Extra Chromed, our Chrome process is composed by 44 steps to warranty the corrosion resistance.
The surface has to resist the laboratory test which consists of withstanding > 200 hours salt spray test without appearing any defect.



RACCORDS EXCENTRÉS - ECCENTRIC NUTS

Leur conception intérieure permet d'éviter les bruits inhérents à la circulation de l'eau.
Fabriqué en laiton CW617 (Sn<0,3%).
Un dispositif installé à l'intérieur des raccords excentrés permet d'absorber le bruit lors du passage de l'eau.

The inner design avoids noises from the water circulation. Produced with CW617 (Sn<0.3%)
One set installed inside the eccentric nut absorbs the noise when the water flows.
Noise reduction around 20 decibels.



GARANTIE CLEVER · WARRANTY

La robinetterie Clever est fabriquée à partir des meilleurs matériaux et composants et a été soumise aux contrôles de qualité les plus stricts.
C'est pourquoi nous offrons une garantie de 5 ans pour TOUTE notre gamme, et de 2 ans pour la robinetterie temporisée.

La robinetterie Clever répond aux critères des normes: UNE 19-703 / UNE 19-707 (EN 200)/ UNE-EN 817 / UNE-EN 816 / UNE-EN 111, et sa qualité est garantie selon la norme ISO 9001.

Clever taps have passed the strictest quality controls as all are produced with the best materials and components in order to offer the comfort and durability. Due to reason we offer 5 years guarantee in all our ranges. Delay action taps 2 years.
Clever taps carry out the following rules: UNE 19-703 /UNE 19-707 (EN 200)/ UNE-EN 817 / UNE-EN 816 / UNE-EN 111, and its quality is guaranteed according to ISO 9001.



EcoNature + ColdOpen



gitec



En plus du système **EcoNature**, la cartouche **C3** intègre le système **ColdOpen d'ouverture en eau froide**. Avec ce type d'ouverture, on obtient une économie de débit, grâce au système Econature, mais aussi d'eau chaude puisque la manette actionnée en position centrale ne libère que de l'eau froide.

The C3 cartridge apart from having Econature system also incorporates ColdOpen function, this means opening in cold. With this type of opening we get a saving not only in flow, thanks to Econature, also in hot water due to the handle in its central position that generates cold water, avoiding to mix hot and cold water from the beginning.

C3



EcoNature system

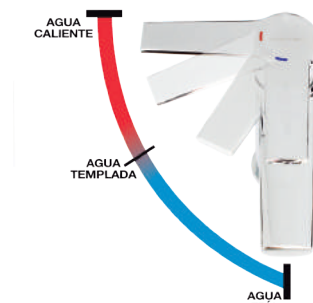

ColdOpen system

Termostatique

Les avantages de la cartouche thermostatique sont nombreux:

Stabilité: la température reste constante.

Confort: les changements de température ou de pression de l'eau sont compensés automatiquement.

Sécurité: en cas d'interruption de l'arrivée d'eau froide, la cartouche bloque immédiatement le passage de l'eau chaude pour éviter les brûlures.

Précision: les mitigeurs sont calibrés à la température précise 38°C

Résistance: modèle de cartouche synthétique spéciale, résistante au calcaire (Ca).

Traçabilité: marquage STH et datage pour un meilleur contrôle et suivi.



cosedal



Stability: the temperature remains constant. Comfort: automatically compensates temperature changes. Safety: If the cold water supplied is interrupted, the cartridge will not let hot water to enter and avoid scalding. Accuracy: taps calibrated at 38 ° C. Exact Temperature. Exactitude: special synthetic cartridge, insensitive to the lime (Ca). Traceability: STH brand and date marked for a higher control and monitoring.

Information technique Technical information



SÉCURITÉ · SECURITY



TERMOLIMIT

Limitation de la température
Temperature limit



Un anneau situé sur la cartouche permet à l'utilisateur de limiter la température de l'eau chaude, obtenant ainsi une économie d'énergie et évitant les brûlures. Idéal pour la sécurité des enfants.



O-ring placed in the cartridge, which allows the end user limit the hot water temperature, saving electricity and avoiding scalds.
It is worth for the child security.



PRM

Hygiène maximale
Maximum hygiene



La manette médicale Clever, comme son nom l'indique, est particulièrement adaptée pour les établissements requérant un niveau d'hygiène optimum.

Cette manette peut être montée sur d'autres mitigeurs de la marque Clever. Consulter notre Département Technique pour plus d'informations.

The Clever hygienic handle is suitable for those places where the hygienic requirements are high.

Moreover the end user can assembly this handle in other Clever taps. Please check with our Technical Department if it suits.



SAFETY BLOCK

Double système de sécurité pour thermostatique
Double security system for thermostatic

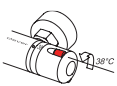

Mécanisme qui évite que des températures supérieures à 38°C soient obtenues de façon involontaire.

L'utilisateur doit presser le bouton de sécurité pour obtenir des températures plus élevées. Idéal pour la sécurité des enfants.

Bloquage automatique en cas d'interruption de l'arrivée d'eau froide sur le réseau.

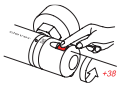

Mechanism which avoids temperatures higher than 38°C in an involuntary way. The end user has to press the button in order to get higher temperatures.

It is perfect for the child security. Automatic block in case it is stopped the cold water supply.



ENVIRONNEMENT - ENVIRONMENT



PUBLIC PLACE

Conçu pour les lieux publics
Designed for public places



Les séries de robinets temporisés Clever sont spécialement conçues pour les lieux publics. Automatiques, équipés d'aérateurs antivandalisme et d'un mécanisme performant d'économie d'eau



The series Clever of Delay Action are specially designed for Public Places.

Automatic, antivandalic, wise system to save water and hidden dismantle system.



RECYCLABLE

Écologique
Ecologic



Clever utilise des matériaux d'emballage recyclables pour toute sa gamme, dans un souci de respect de l'environnement. Le procédé de production est inspecté régulièrement afin de contribuer à la préservation de la nature.



Clever uses recycle packaging in all its range, protecting the environment.

The production process it is inspected periodically, safeguarding the nature conservation.



NOISELESS

Système de réduction des bruits
Noise reduction system



La conception intérieure de notre robinetterie permet d'éviter les bruits inhérents à la circulation de l'eau. Fabriqué en laiton CW617 (Sn<0,3%).

Les raccords de notre robinetterie murale sont équipés de dispositifs silencieux. Ce système permet de réduire les bruits induits sur le réseau de distribution d'eau.

The inner design of our taps avoid noises from the water circuit. A mechanism placed inside our eccentric nut absorbs the noises produced when the water goes through the tap.



WATER REDUCE

Système de réduction de débit
Flow reduction system



Les réducteurs de débit installés sur la robinetterie ou les douchettes permettent une économie d'eau importante en limitant le débit maximum à 9 litres/minute.

The reducing devices provide a significant water saving consumption in taps and shower handles. The maximum volume will be reduced to 9 liters x minute.



PURE H₂O
 Robinetterie pour eau purifiée
 Filter sink mixer

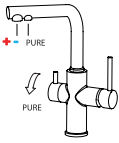

Mitigeurs avec deux sorties: une sortie pour l'eau courante et l'autre pour l'eau purifiée.
 Mixer with two exits: tap and filter water.

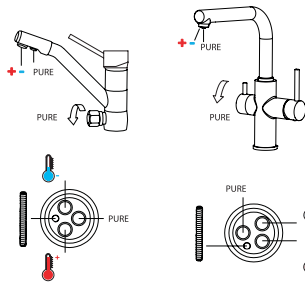

TECHNOLOGIE - TECHNOLOGY

C1
 Cartouche C1 - Standard
 C1 cartridge

Nos cartouches incorporent des disques céramiques synthétiques de haute précision présentant une grande résistance à l'usure. Tous les matériaux de ces cartouches en contact avec l'eau sont conformes aux normes sanitaires telles que l'ACS, la KTW et la W270, Watermark, etc.

Synthesized high precision technical ceramics with high resistance to the corrosion are incorporated. All materials in contact with water complied with international standards such as sanitary ACS, KTW & W270, Watermark, etc.



C2
 Cartouche C2 - Econature
 C2 cartridge



Le système EcoNature se compose d'une cartouche céramique équipée d'un système à 2 positions d'ouverture, permettant une économie d'eau et un grand confort d'utilisation.

The Econature system consists on a cartridge with 2 positions, calibrated at the factory, which offers a high level of comfort and ease use. The system is based on a mechanism located inside the cartridge.



C3
 Cartouche C3 - ColdOpen
 C3 cartridge



En plus du système EcoNature, la cartouche C3 intègre le système ColdOpen d'ouverture en eau froide. Avec ce type d'ouverture, on obtient une économie de débit, grâce au système Econature, mais aussi une économie d'énergie.

The C3 cartridge a part from having Econature system also incorporates ColdOpen function, this means opening in cold. Achieving savings in hot water thanks to the lever in the center position, it generates cold water avoiding any mixing.



WATERFALL
 Effet cascade
 Waterfall effect

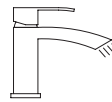

L'effet cascade présente un changement de concept de la robinetterie traditionnelle. L'absence d'aérateur, permet de rehausser l'esthétique du robinet et de reproduire la force intacte de la nature.

Effect WATERFALL provides a change in the taps conception. Without aerator, the faucet heightens its aesthetic one and reproduces the intact force of the nature.



AIR FORCE
 Aérateurs de dernière génération
 Last generation aerators

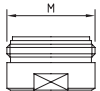

Clever utilise des aérateurs de dernière génération fabriqués par de prestigieuses firmes internationales. Les aérateurs mélangent air et eau afin d'éviter les éclaboussures tout en assurant un débit prédéterminé.

Clever uses in all ranges last aerators generation and prestigious international company. The aerator mix air and water. It avoids the splashes on the washbasin. The water saving is assured.



PULL-OUT
 Robinetterie extractible
 Pull-out taps

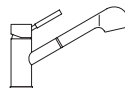

Robinet d'évier à douche extractible.
 Mixer with pull-out spout.



ANTISPLASH SYSTEM
 Système antiéclaboussures
 Anti-splash

Clever a développé un système qui diminue les éclaboussures des mitigeurs évier dépourvus d'aérateurs.

Clever has developed a system which reduces the splashes when using sinks without aerator.



MIRROR EFFECT
 Polissage effet miroir
 Mirror effect

L'application de la technologie CNC au dégrossissage et polissage de la gamme SELENE permet l'obtention d'une surface totalement plane à effet miroir.

The surface polished for VENTU, MARINA EVO and SELENE range is produced using the CNC technology, getting perfect flat sides with mirror effect.

Information technique Technical information



SUPERFIX
Renfort pour éviers
Stop movement for sink mixer



Les robinets de cuisine Clever sont équipés d'une base de renfort qui se fixe sous l'évier afin de stabiliser le robinet si celui-ci est montés sur un support inox.

The Clever sink taps have available a base which is placed in the inferior part of the stainless steel taps, not allowing the mixer's movement.



EASY FIX
Montage sans outils des éviers
Easy sink taps installation

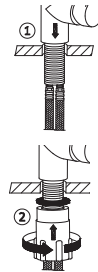

Dispositif qui permet le montage sans besoin d'outil spécifique.

Device that allows the assembly by hand, without any tools.



CERAMIC CONTROL
Disques céramiques
Ceramic disc

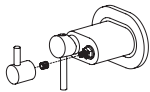

Les têtes ON-OFF tournent à 90° sur des disques céramiques, composés d'oxyde d'aluminium d'une pureté de 99%, inusable. Elles sont équipées d'un isolant thermique pour réduire la conduite de chaleur et éviter les brûlures au contact avec la manette.

The headwork ON-OFF have a 90° turn with ceramic discs, aluminum oxide with a 99% purity, surviving the time going. In order to reduce the high temperature, a thermal insulator it is assembled to avoid scalding when you touch the handle.



ANTICALCAIRE
Dispositif anticalcaire
Anti lime



Des matériaux anticalcaire sont utilisés sur la majorité des éléments de notre robinetterie qui sont en contact avec l'eau, ce qui permet d'éviter l'obstruction du passage d'eau, la diminution du débit et la détérioration de la robinetterie.

All the elements used in our taps which are in contact with the water are anti lime. We avoid obstruct mechanisms and water reduction, and also deteriorate or damage itself the mixer.



HIDE DIVERTER
Inverseur Design
Design diverter



Les nouvelles séries AUDE, ARTIC URBAN et CAIMAN XTREME sont équipées d'un système d'inverseur innovant, sans pomo apparent, combinant esthétique et fonctionnalité.

The series AUDE, ARTIC URBAN and CAIMAN XTREME uses a new diverter, mixing style and function, where the diverter is hidden. When the hose bib is pulled out vertically you do the change.



JET MASSAGE
Robinetterie à jets d'hydromassage
Mixer with hydromassage jets

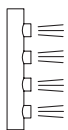

La colonne de douche With2 Morea est équipée de jets orientables.

Range With2 Morea allows to position the jets. We advise to see carefully the extensible bars measures, in order to place jets in the correct height.



EXTRA LENGHT
Flexibles 1,75m
Hose bib 1,75 m

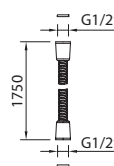

Clever utilise des flexibles de 1,75 m pour tous ses modèles de colonne de douche et bain-douche.

Clever uses 1,75m hose bib length, for all showers, bath-showers. Useful for people all heights.



COLD TOUCH
 Robinetterie anti-brûlure
 Anti-scald

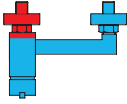

Le design particulier de nos douches et bain-douches avec COLD TOUCH permet d'éviter le risque de brûlure au contact du corps du mitigeur. Idéal pour la sécurité des enfants.

The special design in our Showers and Bath-Showers with COLD TOUCH, makes that the body will not have temperature and will not scald. Ideal for the child security.

THERMOSTATIC COLD TOUCH



98823 - 98478 NINE

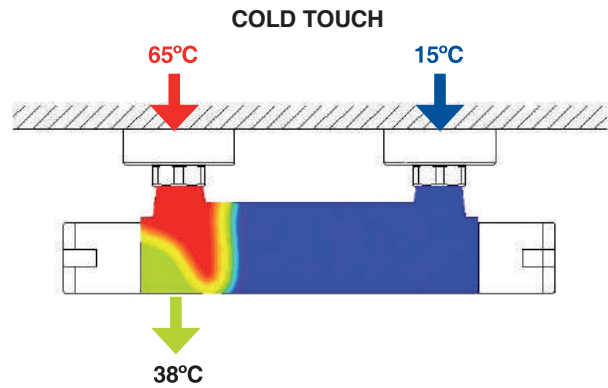
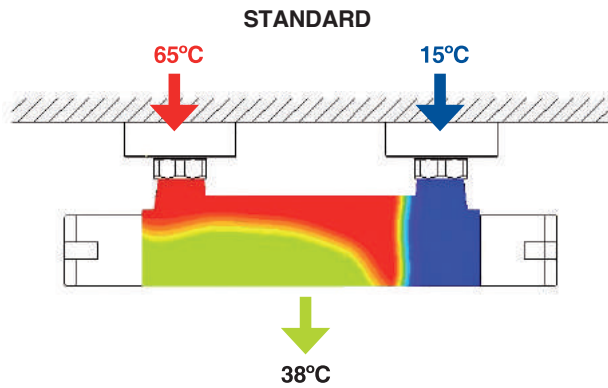

ORIENTABLE
 Aérateur orientable
 Easy sink taps installation

Aérateur permettant d'orienter la direction du jet d'eau pour un plus grand confort.

Aerator that allows to orientate the stream of water to the desired direction, thereby achieving a greater comfort.



ULTRA SLIM
 Aérateur ultra slim
 Ultra Slim aireator

Aérateur plat qui rehausse l'élégance du robinet.

Flush aerator providing character and elegance to the faucet.



COLD OPEN
 Robinetterie avec système d'ouverture en eau froide. Economie d'énergie.
 Cold Open - Energy savings

Le système ColdOpen permet une ouverture en eau froide avec la manette en position centrale et permet ainsi une économie d'énergie. Pour obtenir de l'eau chaude il faut déplacer volontairement la manette vers la gauche.

The Cold open system allows to save hot water thanks to the operation of the handle. In its central position, unlike the rest of the taps, it does not mix hot and cold water, the water is only cold. To obtain hot or warm water, turn the handle to the left.



Information technique

Technical information

DESIGN ET QUALITÉ · DESIGN & QUALITY



TOP WARRANTY
Garantie qualité 5 ans
5 years warranty

La robinetterie Clever est fabriquée à partir des meilleurs matériaux et composants et a été soumise aux contrôles de qualité les plus stricts. C'est pourquoi nous offrons une garantie de 5 ans pour toute notre gamme.

Clever taps are proved under strict quality controls, is for this reason that we offer 5 years guarantee in all our ranges.



TOP WARRANTY
Garantie qualité 2 ans
2 years warranty

Les produits Clever subissent des contrôles de qualité très stricts, nous permettant de vous offrir une garantie de 2 ans sur tous nos accessoires et notre robinetterie temporisée.

Clever taps are proved under strict quality controls, is for this reason that we offer 2 years guarantee in all our accessories.



PATENTED
Design exclusif et breveté
Exclusive and patent design



Clever fait breveter ses designs auprès des autorités compétentes afin de protéger sa spécificité. Les séries AUDE, ARTIC URBAN, PAULA, S12 XTREME et URBAN, PANAM XTREME, START ELEGANCE et XTREME sont protégées pour les 27 pays de l'Union Européenne.

Clever patents its designs at the official draws and marks registration. It is our distinction and the way towards the future. The series AUDE, ARTIC urban, PAULA, S12 xtreme and urban, PANAM xtreme, START elegance and xtreme are exclusive for the 27 UNION EUROPEAN COMMUNITY countries.



BAG PROTECT
Sachet de protection en coton.
Cotton cover bag



Tous les robinets clever sont présentés dans un sachet de protection en coton, qui permet de garantir la qualité du produit et de le protéger jusqu'à son installation.

All Clever ranges have a protective cover, which besides guaranteeing the product quality, once arrives at the user hands allows to protect the mixer in its definitive place till the works have been finished.

MATÉRIAUX · MATERIALS

Pb < 1,6%
Sn < 0,3%
HEALTH BRASS
Faible teneur en plomb
Low percentage of lead

La faible teneur en plomb dans le laiton que nous utilisons nous permet d'être en conformité avec les marchés les plus exigeants.

Low lead content in the metallic alloys, it allows us to take care of the environment and also being able to sell our products to the most strict markets.



EXTRA CHROME
Chromage de haute qualité
High quality chrome

Extra chromage, procédé de chromage en 44 étapes qui garantit la résistance à la corrosion.

La surface doit supporter un test en laboratoire consistant à résister à plus de 200 heures de brouillard salin sans dégradation.

The Chrome plated process takes 44 stages, obtaining 4 brass coats, guarantee 200 hours salty mist without showing any damage.



EXTRA BRASS
Laiton de haute qualité
High quality brass

Laiton conforme à la norme EN 12.164/5. Le laiton utilisé pour la fonte est un alliage avec très peu d'impuretés et sans pores. Le laiton forgé (estampé) s'obtient par extrusion, et est composé d'un haut pourcentage de cuivre (60%), et à faible proportion d'étain. Les éléments sensibles et ceux en contact avec l'eau sont fabriqués avec du laiton CW617, alliage de grande résistance et durabilité.

Brass according to European standard EN 12.164/5. Casting brass is an alloy with few impurities and without pores. Brass forged (stamping) is obtained by extrusion, with high copper levels (60%) which give great elasticity. The low Tin content avoids incidences produced by fatigue. All the main taps parts use brass CW617, which has a great resistance and durability.

Thermostatique *Thermostatics*



H₂O
% Ca₂-Mg₂
CaCO₃ < 12 mg/l

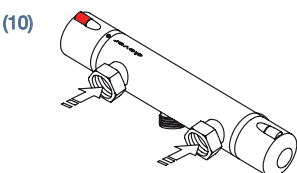
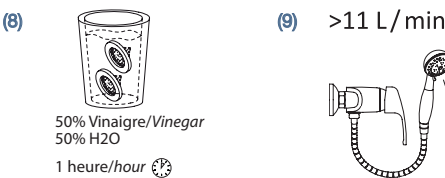
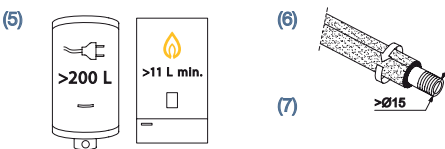
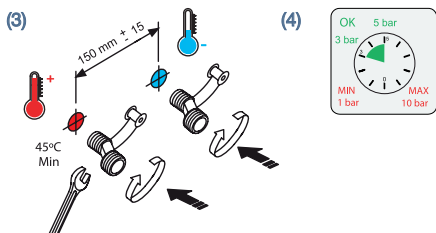
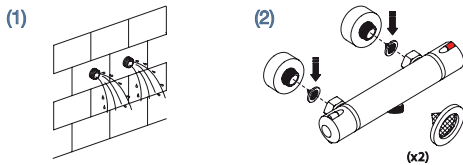
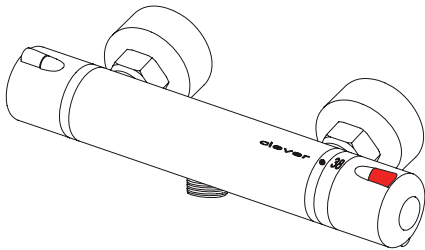

A L'INSTALLATION DE LA ROBINETTERIE THERMOSTATIQUE

- (1) Il faut d'abord purger soigneusement la canalisation afin d'éliminer le sable et toutes particules solides.
- (2) Il est indispensable de placer les filtres aux entrées d'eau chaude et froide.
- (3) Il est indispensable que la prise d'eau chaude soit située à gauche, et la prise d'eau froide à droite.
- (4) Pression: Il faut éviter une pression de l'eau inférieure à 1 bar ou supérieure à 10 bar.
Il est conseillé une pression de 3 à 5 bar. Il est d'autre part recommandé que la différence de pression entre eau chaude et eau froide ne soit pas supérieure à 1 bar.
- (5) Utiliser un chauffage électrique avec la capacité la plus importante possible, minimum 200 litres, ou un chauffage au gaz avec un débit minimum de 11 litres par minute. Les petits chauffages au gaz (6 litres par minute) ne permettent pas un fonctionnement optimal de la robinetterie.
- (6) Nous recommandons une isolation thermique de la tuyauterie eau chaude.
- (7) Nous recommandons l'installation de tubes d'un diamètre minimum de 15 mm.

WHEN INSTALLING THERMOSTATIC TAPS

- (1) Water outlets have to be carefully cleaned to eliminate sand and dirty from inside them.
- (2) It's indispensable to place the filters in the cold and hot inlets.
- (3) It's **INDISPENSABLE** to place hot water inlet in left side and cold water inlet in the right side
- (4) **PRESSURE:** Avoid installing these thermostatic taps when the water pressure is less than 1 bar or more than 10 bar. The recommended pressure is between 3 to 5 bar.
- (5) Use electric heaters with as much capacity as possible, minimum 200 liters, or gas heaters with a minimum capacity of 11 liters per minute. Small gas heaters (6 liter per minute) will not allow the thermostatic tap to work properly.
- (6) We recommend thermal isolation for the hot water pipes.
- (7) We recommend installing pipes with a minimum diameter of 15 mm.

ENTRETIEN

- (8) Il est nécessaire de nettoyer périodiquement les filtres, spécialement si le débit diminue de manière injustifiée, ou si la température ne peut être correctement réglée.
- (9) Si la robinetterie thermostatique ne fonctionne pas correctement, il faut dans un premier temps vérifier le débit qui doit être supérieur à 11 litres par minute.
- (10) Si l'installation complète ne fonctionne pas, vérifier les valves anti retour situées sur chaque entrée.

MAINTENANCE

- (8) Is necessary to clean regularly the filters, especially if the flow-rate decrease unjustifiably, or if temperature cannot be regulated properly.
- (9) If the thermostatic faucet doesn't work correctly, please check the flow-rate, there should be at least 11 liters per minute.
- (10) If the whole installation does not work appropriately, check the two check-valves placed in both inlets.

Information technique Technical information

Changement de cartouche Change cartridge

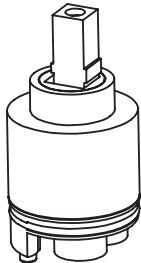

1. Retirer la vis
2. Retirer la manette, dévisser la couverture
3. Retirer la couverture, puis dévisser l'écrou
4. Retirer l'écrou
5. Retirer la cartouche, nettoyer l'intérieur du robinet
6. Changer la cartouche, monter les pièces.

1. Remove screw
2. Remove handle, unscrew the rossette
3. Remove the rossette and unscrew the nut
4. Remove nut
5. Cartridge Remove, clean inside faucet
6. Replace cartridge, assemble parts.

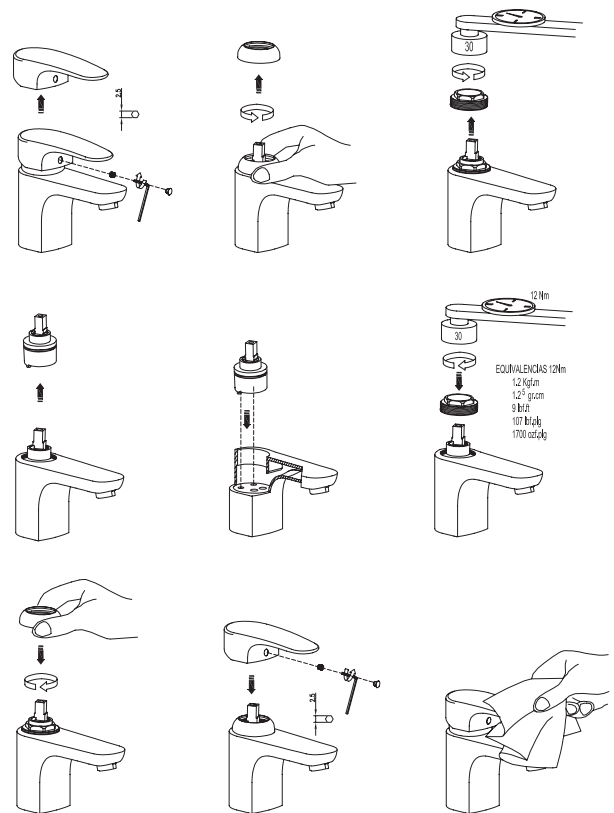

Entretien Maintenance

ENTRETIEN

1. Nettoyer avec un détergent liquide.
 2. Utiliser une éponge, une peau de chamois ou un chiffon doux.
 3. Rincer la robinetterie à l'eau.
 4. Sécher après chaque utilisation.
 5. NE pas utiliser de produits abrasifs (HCl, HNO₃, H₂SO₄...).
- Les produits contenant du chlorure d'hydrogène HCl ou de l'acide chlorhydrique détruisent le chrome en quelques secondes.
6. NE pas utiliser n'importe quel type d'éponge.
- Notre garantie ne couvrira pas les dommages occasionnés par un usage inadéquat.**

MAINTENANCE

1. Clean with liquid detergent.
 2. Use a sponge, suede or soft flannel.
 3. Rinse the tap with water.
 4. Dry after every use.
 5. DO NOT use acids or abrasive products (HCl, HNO₃, H₂SO₄...).
- Products containing HCl, hydrochloric acid (muriatic acid) must be completely avoided, they destroy chrome in few seconds.
6. DO NOT use any type of scouring pad.

Our guarantee does not cover damage caused by any inappropriate use.

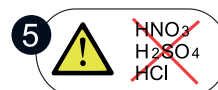
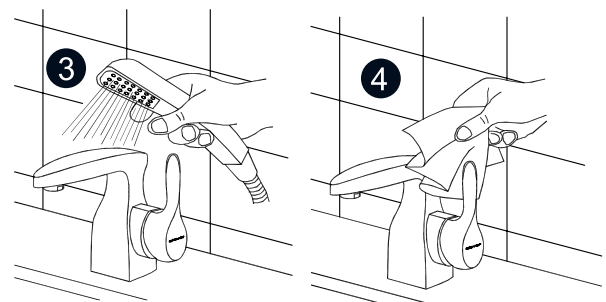
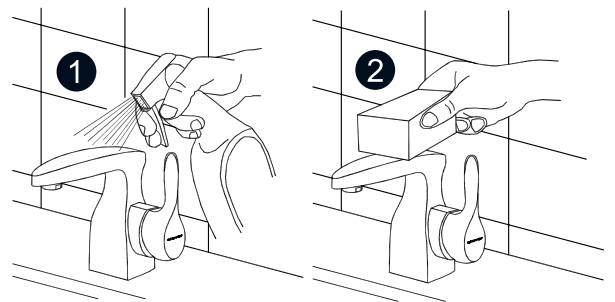

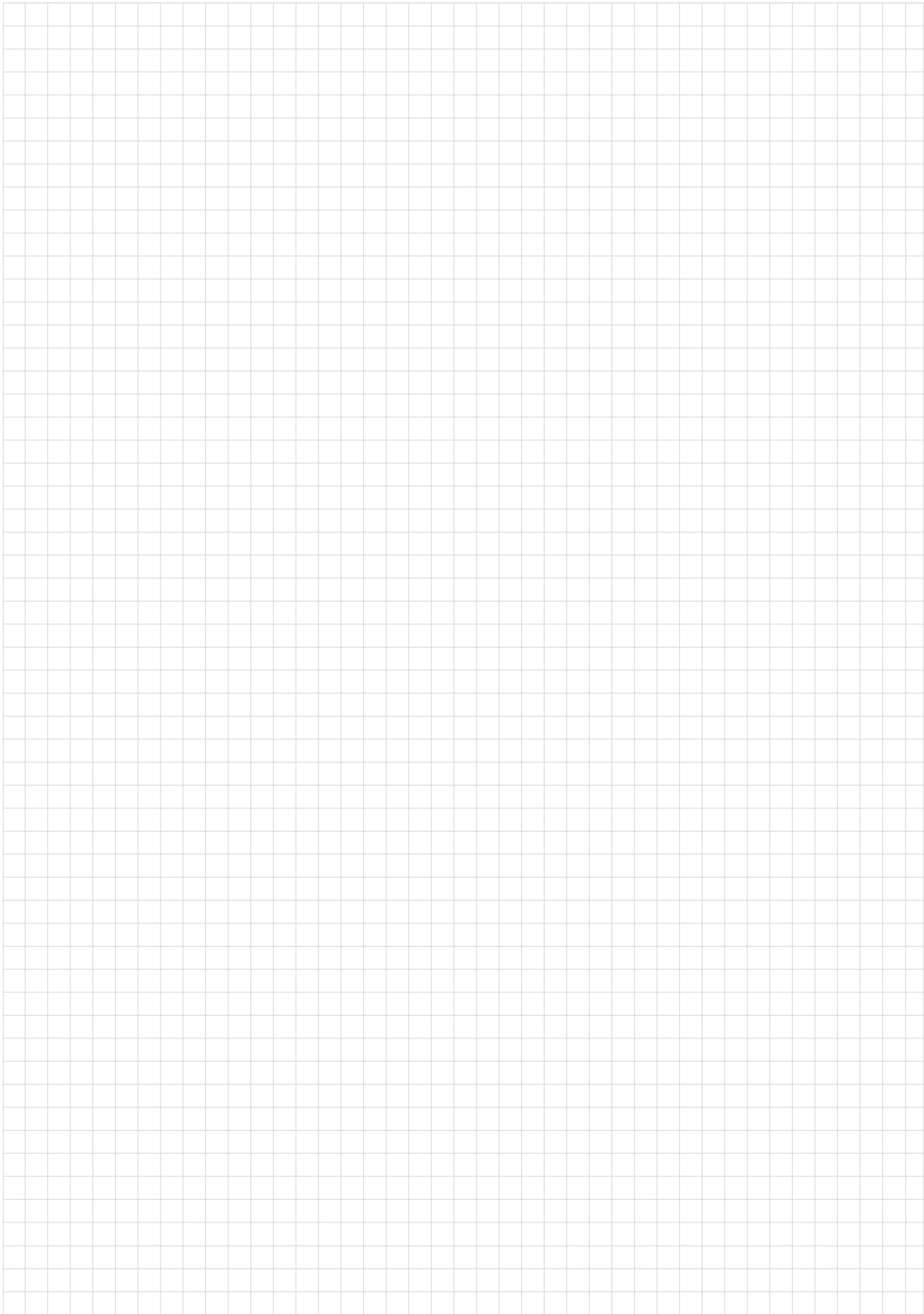

Conditions de vente

Conditions générales de vente

1. Généralités

Les ventes effectuées par le Groupe STH, composé des sociétés Standard Hidráulica, Hidrostandard del Mediterráneo et Comap Ibérica, seront assujetties aux présentes Conditions générales de vente, à l'exception des cas particuliers accordés expressément sur l'offre ou la confirmation de commande.

2. Prix

Les prix figurant dans notre tarif sont exprimés en €, hors taxes, et en conditions Ex Works Montcada i Reixac. Le montant minimum des commandes pour obtention du Franco de Port sera déterminé en fonction des conditions particulières de chaque pays et client.

Le Groupe STH se réserve le droit de modifier les prix du tarif en vigueur, sans délai d'avis préalable. Les prix appliqués seront ceux de la date de réception de la commande. Les frais d'envoi d'échantillons seront à la charge du client.

3. Délais de livraison

Les commandes reçues sans indication de date de livraison seront livrées dans le meilleur délai possible. Les délais de livraison qui figurent sur la confirmation de commande le sont à titre indicatif. Les livraisons anticipées et/ou partielles sont considérées autorisées, sauf accord contraire par écrit. Le non-respect des délais pour des raisons de grève, d'échec des négociations, de clôture d'entreprise et les raisons dérivées de ces situations seront considérées de force majeure ne pourront constituer un motif de droit ou de pénalité, ni de dommages et intérêts au bénéfice de l'acheteur. En cas de retard ou de non-paiement, ou si les sommes dues dépassent le montant assuré par notre compagnie d'assurance, les commandes en attente de livraison seront bloquées jusqu'à résolution de la situation.

4. Facturation

Le Groupe STH se réserve le droit d'envoyer et de facturer les commandes du client par le biais des différentes sociétés du Groupe selon la situation de crédit du client. Les données du fournisseur seront indiquées sur le bon de livraison. Aucune modification ne sera admise après expédition.

Le groupe STH utilise un système de communication électronique pour l'envoi des factures.

5. Conditions de paiement

Le financement ne pourra en aucun cas excéder les paramètres définis dans la Loi 15/2010 qui stipule les mesures contre les retards de paiement dans les opérations commerciales. Le non-paiement d'une facture à son échéance entraînera la suspension immédiate de toute autre livraison. Lorsque le Groupe STH accordera au client un délai dans le paiement d'une facture au-delà de la date d'échéance initialement accordée, il sera appliqué une pénalisation de 3% mensuels sur le montant de la facture. En cas de non-paiement, cette pénalisation sera de 5% mensuels, avec un seuil de 15 €, auxquels s'ajouteront 3% mensuels à partir du 2ème mois de retard. Tout paiement reçu sera imputé en premier lieu aux éventuelles pénalisations pour retards ou impayés, puis au montant principal des dettes les plus anciennes, indépendamment du concept indiqué par le client. Toutes les transactions commerciales sont assurées par une compagnie d'assurance-crédit.

6. Retours de marchandise

Toutes les demandes de retour devront être dûment documentées par le client et présenter la facture relative à l'achat, puis analysées et acceptées par le Groupe STH. Les retours de marchandise pour défaut d'identité et/ou de quantité devront être effectués dans les 7 jours suivant la réception du matériel. Toute autre demande de retour devra être analysée en fonction des critères définis par le groupe STH. Aucun retour de matériel déclassé ou hors garantie ne sera accepté. Les retours acceptés par le Groupe STH seront crédités en leur appliquant une baisse de valeur d'entre 15% et 50% en fonction de l'année d'achat du matériel. Frais de port à la charge du client.

7. Réclamations, garantie et compensation

Conformément aux dispositions légales, en cas de dommage ou d'avarie de la marchandise transportée ou en cas d'incidence sur les quantités, le client devra procéder aux réserves d'usage auprès du transporteur à la réception du matériel ou dans les 24 h. suivantes.

Le groupe STH garantit la robinetterie de ce catalogue pendant 5 ans contre d'éventuels défauts de fabrication.

La garantie pour les cartouches thermostatiques, temporisées et les mécanismes électroniques, ainsi que pour les accessoires (flexibles, douchettes, pommes de douche, barres de douche, etc.) est de 2 ans.

La date d'acquisition devra être dûment justifiée par présentation de la facture d'achat correspondante. La garantie ne sera appliquée que dans les cas où le défaut est confirmé par le Département Technique.

Notre garantie ne s'étend pas aux défauts résultant d'un mauvais emploi, d'un montage non conforme aux prescriptions, de négligence dans l'entretien ou dans l'utilisation du produit.

Sont également exclus de la garantie tout dommage lié à la qualité de l'eau.

La garantie couvre l'envoi des produits sans frais, notre responsabilité restant limitée au remplacement ou à la réparation des pièces reconnues défectueuses par le groupe STH, sans aucune indemnisation. Dans le cas où le produit ne soit plus fabriqué, nous nous engageons à livrer un produit similaire de même qualité.

Les cartouches thermostatiques, temporisées et mécanismes électroniques ont une garantie de 2 ans.

Les accessoires (flexibles, douchettes, pommes de douches, supports, barres de douches, etc.) ont une garantie de 2 ans.

Nous nous réservons le droit de modifier le design de nos produits sans avis préalable.

8. Réserve de propriété

Le Groupe STH sera propriétaire des produits livrés au client jusqu'au complet encaissement de la facture correspondante.

9. Responsabilité civile dérivée du produit

Le groupe STH ne peut être considéré responsable que des défauts de qualité internes du produit déjà existants lors de l'expédition au client. Le groupe STH ne peut être tenu pour responsable des dommages dérivés d'un défaut de qualité apparent et qui aurait dû être constaté par le client avant sa revente, son installation ou montage, ainsi que de ceux dérivés d'une erreur d'installation et/ou d'une manipulation de ces produits non conforme aux conditions de montage, de mise en fonctionnement (indiqués dans les instructions de montage) ou des conditions administratives établies.

Les limites de la responsabilité seront appliquées aux acheteurs successifs, avec l'obligation d'être adoptées par tous les futurs acheteurs.

10. Dommages aux destinataires

Dans le cas où le client prenne connaissance de la production de dommages à un destinataire qui pourraient être dérivés des produits (et tout particulièrement en cas de réclamation formelle ou légale de la part du destinataire au client), ce dernier devra le signaler de toute urgence et par écrit au Groupe STH, et lui fournir la preuve desdits dommages ainsi que leur cause et leur estimation, afin de pouvoir établir au mieux les responsabilités et ne pas laisser le Groupe STH sans défense.

Le Groupe STH décline toute responsabilité en cas de réclamation pour dommages relatifs aux produits (provenant d'actions directes ou répétées), si la possibilité de pouvoir évaluer et vérifier la réalité des dommages et leur cause ne lui a pas été donnée.

11. Limitation de la responsabilité civile dérivée du produit

Le montant maximum de l'indemnité qui pourra être assumé par le Groupe STH en matière de responsabilité civile dérivée des dommages causés par ses produits est fixé à 2000 euros.

12. Juridiction

En cas de contentieux dans le cadre de la relation contractuelle entre le Groupe STH et le client, le Tribunal de Barcelone sera seul compétent. La loi espagnole sera la seule applicable.

13. Validité

Ces conditions de vente remplacent toutes les précédentes et resteront en vigueur jusqu'à une nouvelle publication sur www.standardhidraulica.com

Sales conditions

Sales conditions

1.General

Sales done by STH GROUP (Standard Hidraulica, S.A.U., Hidrostandard del Mediterráneo, S.A.U. and Comap Ibérica), will be regulated by these sales conditions, except for those which are agreed on the offer or order confirmation.

2.Prices

All prices in the catalogue are in Euros, and these are exclusive of VAT which will, if applicable, be added to the invoice at the current rate.

STH Group consider acceptable a minimum order of 200euros, except for Clever that there is no minimum order.

The Order amount for having the transport paid, it will be depending on the country and the customer.

When we talk about the samples these will be always invoiced and afterwards when we get the Project, we will issue the credit note.

3.Delivery of the goods

Orders with no specific delivery time, will be dispatched as soon as possible.

The delivery dates appearing on the order confirmation are only estimates, advanced deliveries and partial dispatches will be authorized if there is no written agreement that forbids them.

Any incapacity to effect or supplies an order for reasons such as: strike, breakdown of the negotiations, close the business and all their consequences will be considered a majeure force and release STH Group from his obligation to supply the goods and the customer may not make any claim for damages.

In the case of postponing the payment of the outstanding invoices, as well as unsettle them and exceed the limit of the assured credit, the outstanding orders will be kept in our warehouse until the incident is solved.

STH Group will be the owner of the goods until the invoice is settled in full.

4.Invoices

All the commercial deals are insured by an Insurance Company. STH Group reserves the right to invoice the customer by any company from the Group depending the Insurance amount the client has. The company's details will be informed in the delivery note, without any possible change once we send it. STH Group works with electronic invoicing.

5.Payment conditions

Maximum payment terms will never exceed the factors fixed in the law 15/2010.

To unpaid an invoice on its due date it will force to stop the deliveries of other shipments.

The payment conditions in the invoice will be considered as unconditional: every change must be agreed in advanced

The Company reserves the right to charge interest at a rate up to 3% monthly, and the non-payment will be charged up to 5%, with a minimum amount of 15 €, and 3% will be added each month from the second month of the delay.

It does not matter the payment subject, once STH Group receives the payment always it will be deduced first the penalties.

If the payment is not insured, STH Group will agree with the client the payment terms.

6.Returned goods and dispatch

All the devolutions must be analysed and accepted by STH Group, previously being informed by the customer about the inconveniences and the invoice number.

The returns caused due to delivery mistakes, like identity errors or/and quantity discrepancies, should be managed the following 7 days after its delivery.

The goods which have been returned for different reasons that the ones mentioned before, will be charged with a demerit (from the 15% until the 50%), and the transport costs will be paid by the customer.

The products which are discontinued and are out of guarantee will not be accepted.

7.Claims, warranty and compensation

Any fault or anomaly, including a shortfall in the assured quality of the product, must be reported in writing within the following 24hours after its reception unless the problem cannot be seen easily.

The guarantee that will be applied to the products of the STH Group will be 2 years and 5 years for the mixers, except for:

- Thermostatic cartridges, delay actions and electronic mechanisms will have 2 years guarantee.

- Accessories will also have 2 years guarantee (hose bibs, hand showers, rain showers, holders, sliding bars...)

To all effects, the guarantee will start from the invoice date on. It will be excluded from the guarantee all the products damaged on their installation, maintenance and cleaning which is not done according the rules and its unappropriated use.

The guarantee covers to replace or repair the goods, if these are discontinued will be substitute them for similar ones.

We reserve the right to modify any product design without informing previously.

8. Civil Liability

Outside the application of the product liability's laws, the Company will only be responsible for damage, if according to legal resolutions, serious blame is proved.

The Company will not reply and there will be no claim for damages in the case of non-fulfilment of assembly conditions, come into operation and use (such as in the instructions of use) or in the established administrative conditions. The limitations of responsibility will be applied in full on successive purchasers and must be adopted by all future ones.

Once the customer knows the damage caused by one faulty product, he must inform immediately STH Group in a writing way and add all the necessary information to show causes and possible responsibilities for STH Group defence.

The maximum limit of liability which will be paid by STH Group derived from a faulty product will be 2.000€

9. Consignee damages

In the case that STH Group products cause damages on an installation (especially when it is officially demanded by the customer), it should be informed urgently in a written way to STH Group, and send the verification, the estimation of damages and its causes.

10. Jurisdiction and applicable Law

With respect to all lawsuits that might arise within the framework between the Company and the customer contractual relationship, the Courts and Tribunals of Barcelona will hold all competence. Likewise, it is agreed that the applicable Law will be Spanish Law.

11. Validity.

These Sales Conditions cancel the previous ones and they will be valid till any modification is published in our website www.standardhidraulica.com



NOTES

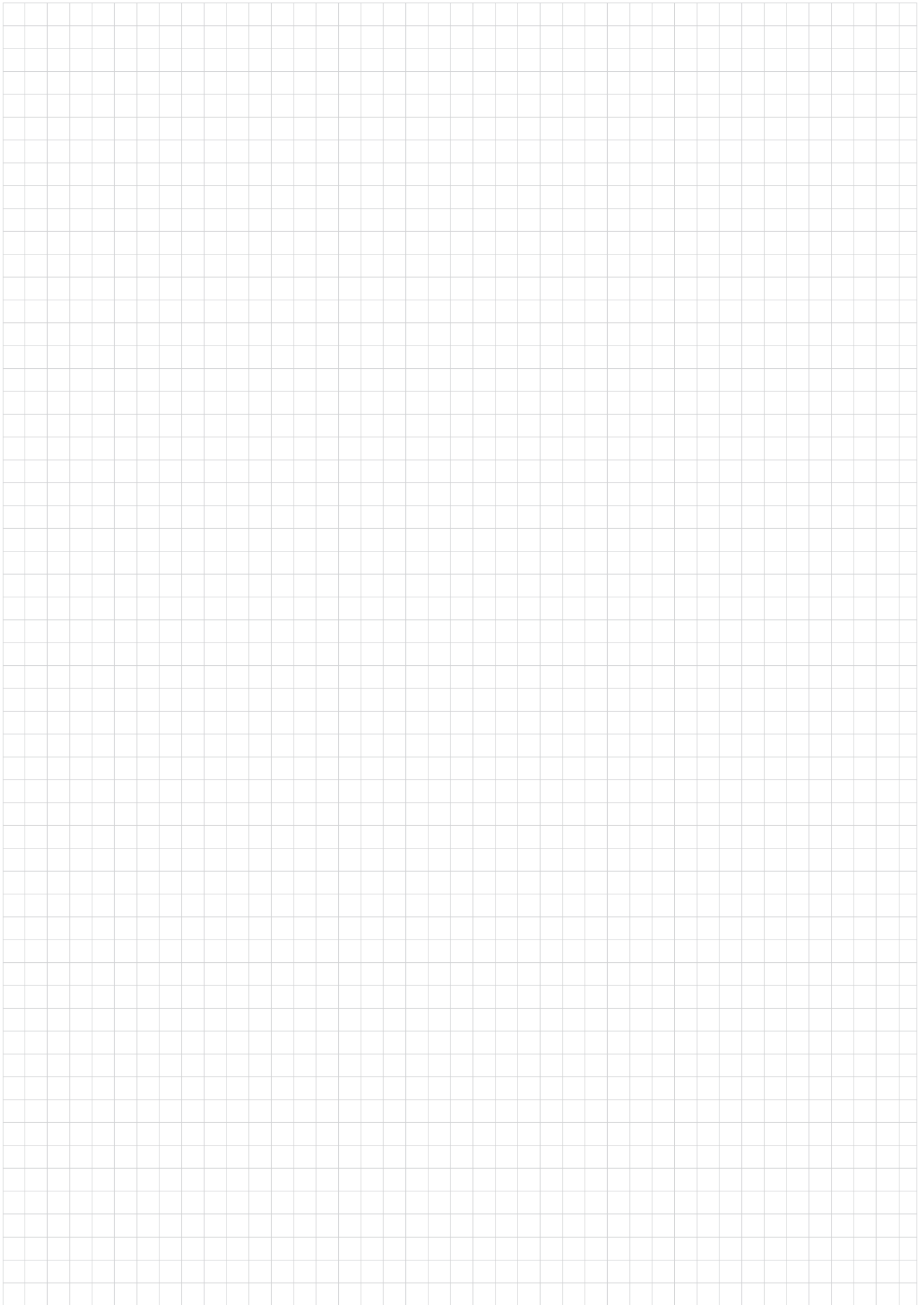

Chaque design,
une émotion

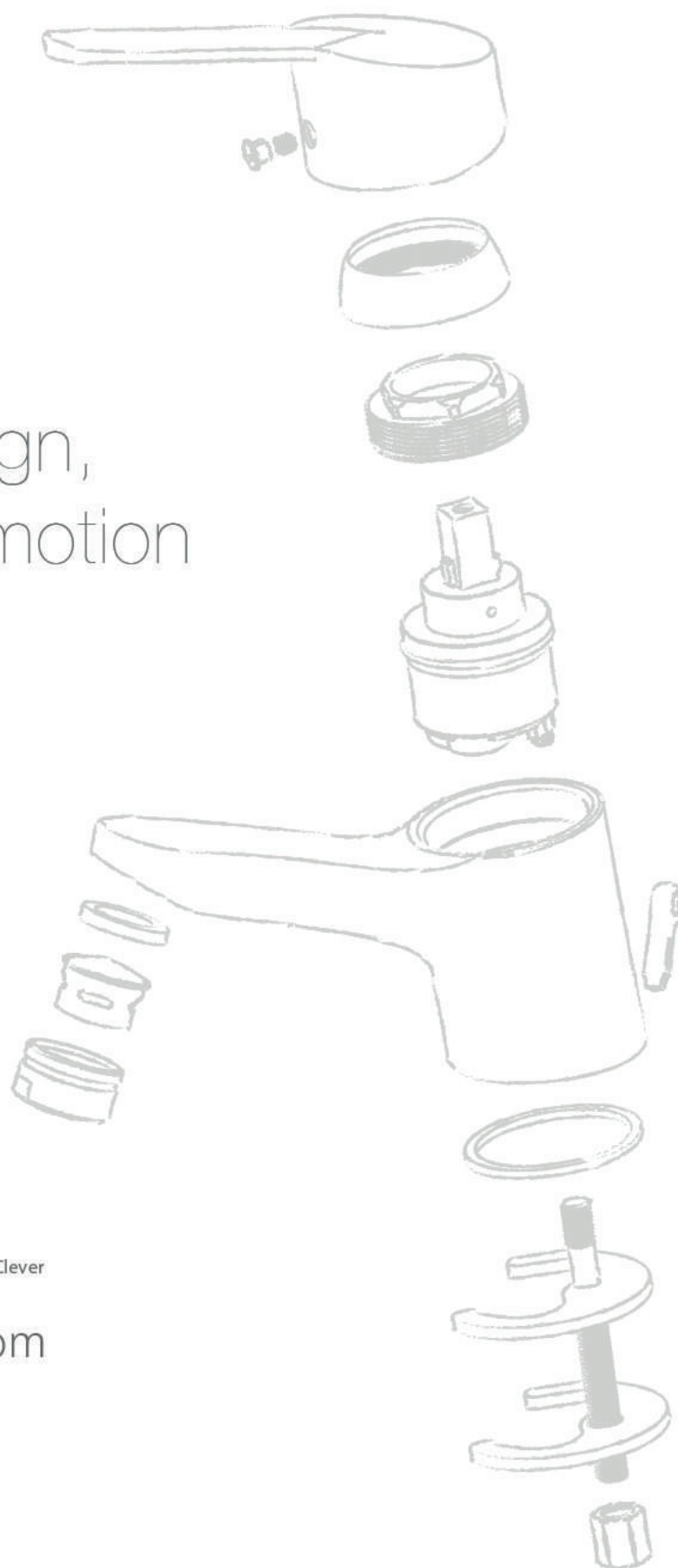

 @CleverGriferia  GriferiaClever  GriferiaClever

www.robinetterieclever.com

Standard Hidráulica S.A.U.

Avenida La Ferrería, 73-75 · Pol. Ind. La Ferrería
08110 - Montcada i Reixac · Barcelona (Spain)
Tel. +34 93 564 10 94 · info@griferiaclever.com

SEDE MADRID

C. Sierra Morena, 15
28320 Pinto (Spain)
+34 91 643 18 86 / +34 91 692 05 53